



# The Gerber Layer Format Specification

---

A format developed by Ucamco

It is named in honor of Joseph Gerber,  
inventor, entrepreneur, and a pioneer in photoplotting.

Revision 2021.11



# Contents

---

<b>Contents .....</b>	<b>2</b>
<b>Preface.....</b>	<b>7</b>
<b>1 Introduction .....</b>	<b>8</b>
1.1 Scope and Target Audience.....	8
1.2 Further Resources .....	8
1.3 Reference Gerber Viewer .....	8
1.4 Copyright and Intellectual Property .....	9
<b>2 Overview .....</b>	<b>10</b>
2.1 File Structure.....	10
2.2 Apertures.....	10
2.3 Graphical objects .....	11
2.4 Draws and Arcs.....	12
2.5 Operations (D01, D02, D03) .....	13
2.6 Graphics State .....	14
2.7 Polarity .....	16
2.8 Blocks.....	17
2.9 Attributes .....	17
2.10 Commands Overview .....	18
2.11 Processing a Gerber File .....	19
2.12 Glossary.....	21
2.13 Annotated Example Files.....	24
2.13.1 Example: Two Square Boxes .....	24
2.13.2 Example: Polarities and Apertures .....	26
2.14 Conformance .....	30
<b>3 Syntax .....</b>	<b>31</b>
3.1 Character Set.....	31
3.2 Grammar Syntax .....	31
3.3 Commands.....	33
3.4 Data Types.....	35
3.4.1 Integers .....	35
3.4.2 Decimals.....	35
3.4.3 Strings .....	35
3.4.4 Fields.....	36
3.4.5 Names .....	36
3.5 Full Grammar of the Gerber Format.....	37

3.6 File Extension, MIME Type and UTI .....	43
<b>4 Graphics.....</b>	<b>44</b>
4.1 Comment (G04) .....	44
4.2 Coordinate Commands .....	45
4.2.1 Unit (MO).....	45
4.2.2 Format Specification (FS).....	47
4.3 Aperture Definition (AD).....	48
4.3.1 AD Command.....	48
4.3.2 Zero-size Apertures .....	49
4.3.3 Examples.....	49
4.4 Standard Aperture Templates .....	50
4.4.1 Overview.....	50
4.4.2 Circle .....	50
4.4.3 Rectangle .....	52
4.4.4 Obround .....	53
4.4.5 Polygon .....	54
4.4.6 Transparency of Holes .....	55
4.5 Aperture Macro (AM).....	56
4.5.1 Primitives.....	58
4.5.2 Exposure Parameter.....	67
4.5.3 Rotation Parameter .....	68
4.5.4 Macro Variables and Expressions .....	69
4.5.5 Examples.....	70
4.6 Set Current Aperture (Dnn).....	74
4.7 Interpolation State Commands (G01,G02,G03,G75).....	75
4.7.1 Linear Interpolation (G01).....	75
4.7.2 Circular Interpolation (G02, G03, G75).....	76
4.8 Operations (D01/D02/D03) .....	80
4.8.1 Overview.....	80
4.8.2 Interpolate (D01).....	82
4.8.3 Move (D02).....	82
4.8.4 Flash (D03).....	82
4.8.5 Example .....	83
4.9 Aperture Transformations (LP, LM, LR, LS).....	84
4.9.1 Overview.....	84
4.9.2 Load Polarity (LP).....	86
4.9.3 Load Mirroring (LM).....	86
4.9.4 Load Rotation (LR) .....	86
4.9.5 Load Scaling (LS).....	87
4.9.6 Example .....	87
4.10 Region Statement (G36/G37) .....	89
4.10.1 Region Overview .....	89
4.10.2 Region Statement Syntax.....	90

4.10.3 Valid Contours .....	90
4.10.4 Examples .....	92
4.10.5 Copper Pours, Power and Ground Planes .....	108
4.11 Block Aperture (AB) .....	110
4.11.1 Overview of block apertures .....	110
4.11.2 AB Statement Syntax .....	110
4.11.3 Usage of Block Apertures .....	111
4.11.4 Example .....	112
4.12 Step and Repeat (SR) .....	114
4.13 End-of-file (M02) .....	117
4.14 Numerical Accuracy .....	118
4.14.1 Visualization .....	118
4.14.2 Image Processing .....	118
<b>5 Attributes .....</b>	<b>120</b>
5.1 Attributes Overview .....	120
5.2 File Attributes (TF) .....	122
5.3 Aperture Attributes (TA) .....	122
5.3.1 Aperture Attributes on Regions .....	123
5.4 Object Attributes (TO) .....	123
5.5 Delete Attribute (TD) .....	124
5.6 Standard Attributes .....	125
5.6.1 Overview .....	125
5.6.2 .Part .....	127
5.6.3 .FileFunction .....	128
5.6.4 .FilePolarity .....	132
5.6.5 .SameCoordinates .....	133
5.6.6 .CreationDate .....	133
5.6.7 .GenerationSoftware .....	134
5.6.8 .ProjectId .....	134
5.6.9 .MD5 .....	135
5.6.10 .AperFunction .....	136
5.6.11 .DrillTolerance .....	144
5.6.12 .FlashText .....	144
5.6.13 .N (Net) .....	146
5.6.14 .P (Pin) .....	148
5.6.15 .C (Component Refdes) .....	149
5.6.16 . Cxxx (Component Characteristics) .....	150
5.7 Text in theImage .....	152
5.8 Examples .....	153
<b>6 PCB Fabrication and Assembly Data .....</b>	<b>155</b>
6.1 Structure .....	155

6.2	Mandatory Attributes .....	155
6.3	Alignment .....	155
6.4	Pads .....	155
6.5	The Profile .....	155
6.6	Drill/rout files .....	156
6.6.1	Backdrilling .....	156
6.6.2	Example Drill File.....	157
6.7	Drawings and Data.....	160
6.8	The CAD Netlist .....	161
6.8.1	Benefits of Including the CAD Netlist.....	161
6.8.2	IP Considerations .....	162
6.9	PCB Assembly Data.....	163
6.9.1	Overview.....	163
6.9.2	Assembly Data Set.....	163
6.9.3	Annotated Example Component Layer.....	164
<b>7</b>	<b>Errors and Bad Practices .....</b>	<b>166</b>
7.1	Errors .....	166
7.2	Bad Practices .....	168
<b>8</b>	<b>Deprecated Format Elements .....</b>	<b>170</b>
8.1	Deprecated Commands .....	170
8.1.1	Overview.....	170
8.1.2	Axis Select (AS).....	171
8.1.3	Image Name (IN).....	172
8.1.4	Image Polarity (IP).....	172
8.1.5	Image Rotation (IR) .....	173
8.1.6	Load Name (LN) .....	174
8.1.7	Mirror Image (MI).....	174
8.1.8	Offset (OF) .....	175
8.1.9	Scale Factor (SF) .....	176
8.1.10	Single-quadrant arc mode (G74).....	178
8.2	Deprecated Command Options.....	182
8.2.1	Format Specification (FS) Options .....	182
8.2.2	Rectangular Hole in Standard Apertures.....	183
8.2.3	Draws and Arcs with Rectangular Apertures.....	184
8.2.4	Macro Primitive Code 2, Vector Line .....	185
8.2.5	Macro Primitive Code 22, Lower Left Line.....	185
8.2.6	Macro Primitive Code 6, Moiré .....	186
8.3	Deprecated Syntax Variations.....	187
8.3.1	Combining G01/G02/G03 and D01 in a single command. ....	187
8.3.2	Coordinate Data without Operation Code.....	188
8.3.3	Style Variations in Command Codes.....	188

8.3.4 Deprecated usage of SR .....	188
8.4 Deprecated Attribute Values .....	188
8.5 Standard Gerber (RS-274-D) .....	190
<b>9 References.....</b>	<b>191</b>
<b>10 History.....</b>	<b>192</b>
<b>11 Revisions .....</b>	<b>194</b>
11.1 Revision 2021.11 .....	194
11.2 Revision 2021.04 .....	194
11.3 Revision 2021.02 .....	194
11.4 Revision 2020.09 – X3.....	194
11.5 Revision 2019.09 .....	195
11.6 Revision 2019.06 .....	195
11.7 Revision 2018.11 .....	195
11.8 Revision 2018.09 .....	195
11.9 Revision 2018.06 .....	195
11.10Revision 2018.05 .....	196
11.11Revision 2017.11 .....	196
11.12Revision 2017.05 .....	196
11.13Revision 2017.03 .....	196
11.14Revision 2016.12 – Nested step and repeat.....	196
11.15Revision 2016.11 .....	197
11.16Revision 2016.09 .....	197
11.17Revision 2016.06 .....	197
11.18Revision 2016.04 .....	198
11.19Revision 2016.01 .....	198
11.20Revision 2015.10 .....	198
11.21Revision 2015.07 .....	198
11.22Revision 2015.06 .....	198
11.23Revision J3 (2014 10).....	199
11.24Revision J4 (2015 02).....	199
11.25Revision J2 (2014 07).....	199
11.26Revision J1 (2014 02) – X2 .....	199
11.27Revision I4 (2013 10).....	199
11.28Revision I3 (2013 06).....	199
11.29Revision I2 (2013 04).....	199
11.30Revision I1 (2012 12).....	199

# Preface

---

The Gerber format is the de facto open standard for printed circuit board (PCB) design data transfer. As a UTF-8 human-readable format Gerber is portable and easy to debug. It is compact and unequivocal, and simple - there are just 27 commands. Every PCB design system outputs Gerber files and every PCB fabrication software inputs them. Implementations are thoroughly field-tested. Gerber's widespread availability allows PCB professionals to exchange PCB design data securely and efficiently. It has been called "the backbone of the electronics fabrication industry".

Gerber is at its core is an open vector format for 2D binary images specifying PCB copper layers, solder mask, legend, etc. Attributes transfer meta-information with the images. Attributes are akin to labels expressing, for example, that an image represents the top solder mask, or that a pad stack is a via or component stack, and which components are positioned where. Attributes transfer the meta-information necessary for fabrication and assembly. A set of well-constructed Gerber files reliably and productively transfers PCB fabrication from design to fabrication, and component information to assembly.

Although other data formats have appeared, they have not displaced Gerber. The reason is simple. Any problems in PCB fabrication data transfer are not due to limitations in the Gerber format but are due to poor practices and poor implementations. The new formats are more complicated and less transparent. To quote Günther Schindler: ""There are no superfluous, production-specific attributes like in other CAM formats. Gerber X2 is simple and tidy." Poor practices and poor implementations in unfamiliar, new and complicated formats are more damaging than in a well-known, well-tested and simple format. The industry has not adopted new formats. Gerber remains the standard.

Ucamco continuously clarifies this document and adapts it to current needs based on input from the user community. Ucamco thanks the individuals that help us with comments, criticism, and suggestions.

The Gerber format was named after Joseph Gerber, who fled his native Austria from the Nazis, and arrived penniless in the USA, alone with his mother. With his technical genius and work ethic he became a very successful inventor and technical entrepreneur. The American dream came true. Mr. Gerber pioneered photoplotting in PCB fabrication, which is the link with the format. Ucamco is honored to look after a format called after this brilliant man.

The emergence of Gerber as a standard for PCB fabrication data is the result of efforts by many individuals who developed outstanding software for Gerber files. Without their dedication there would be no standard format in the electronics fabrication industry. Ucamco thanks these dedicated individuals.

Karel Tavernier

Managing Director,  
Ucamco

# 1 Introduction

---

## 1.1 Scope and Target Audience

This document specifies the Gerber layer format, a UTF-8 format for representing PCB fabrication data. The Gerber format is the de facto standard in the printed circuit board (PCB).

This specification is intended for developers and users of Gerber software. A basic knowledge of PCB design or fabrication is assumed, and knowledge about PCB CAD/CAM is helpful.

## 1.2 Further Resources

The Ucamco website contains articles about the use of the Gerber format as well as sample files. For more information about Gerber or Ucamco see [www.ucamco.com](http://www.ucamco.com), or mail to [gerber@ucamco.com](mailto:gerber@ucamco.com)

Ucamco strives to make this specification easy to read and unequivocal. If you find a part of this specification unclear, please ask. Your question will be answered, and it will be considered to improve this document. We are grateful for any suggestion for improvement.

## 1.3 Reference Gerber Viewer

Ucamco provides a reference Gerber file viewer - free of charge – at [gerber-viewer.ucamco.com](http://gerber-viewer.ucamco.com).

The Reference Gerber Viewer provides an *easy-to-use reference* for both X1 and X2 Gerber files. - the utmost care was taken to display valid Gerber files correctly. It gives a clear warning on risky errors. It is a convenient complement to the written specification. (The specification has precedence if it conflicts with the viewer.)

The Reference Gerber Viewer is an easy tool to *review PCB fabrication data*. For completeness, it also displays drill files in NC format and netlists in IPC-D-356 files. If X2 is used the layer structure is displayed, and the function of all objects can be checked – e.g. whether a drill hole is a via or a component hole.

As the Reference Gerber Viewer is a cloud-based on-line web service there is no software to download, install and maintain –it is always up to date. It is simple and easy to learn. It offers the following benefits:

- *For developers*, it provides an easy way to test their Gerber output and to answer questions about the interpretation of the specification.
- *For users of Gerber files*, it provides an easy way to check the file they have received or are about to send, and to settle discussions about the interpretation of a file.

*It is allowed to integrate a link to the online reference viewer in your website. Email us a [gerber@ucamco.com](mailto:gerber@ucamco.com) for more information.*



## 1.4 Copyright and Intellectual Property

© Copyright Ucamco NV, Gent, Belgium

Ucamco owns copyrights in this document. All rights reserved. No part of this document or its content may be re-distributed, reproduced or published, modified or not, translated or not, in any form or in any way, electronically, mechanically, by print or any other means without prior written permission from Ucamco. One reason Ucamco must retain its copyright in the Gerber Format® specification is to maintain the integrity of the standard.

The information contained herein is subject to change without prior notice. Revisions may be issued from time to time. This document supersedes all previous versions. Users of the Gerber Format®, especially software developers, must consult [www.ucamco.com](http://www.ucamco.com) to determine whether new revisions were issued.

Ucamco developed the Gerber Format®. All intellectual property contained in this document is solely owned by Ucamco. By publishing this document Ucamco has not granted any license to or alienated any rights in the intellectual property contained in it.

Gerber Format® is a Ucamco registered trademark. By using the name Gerber this document or developing software interfaces based on this format, users agree, not to (i) rename the Gerber Format®; (ii) associate the Gerber Format® with data that does not conform to the Gerber format specification; (iii) develop derivative versions, modifications, or extensions without prior written approval by Ucamco; (iv) make alternative interpretations of the data; (v) communicate that the Gerber Format® is not owned by Ucamco, explicitly or implied. Whatever other conditions may apply, by using the name Gerber Format®, or the intellectual property contained in this document, developers of software interfaces for the Gerber Format®, agree to make a reasonable effort to comply with the latest revision of the specification, including the Conformance in section 2.14 to safeguard the integrity of the standard.

The material, information and instructions are provided AS IS without warranty of any kind, either express or implied. Ucamco does not warrant, or makes any representations regarding, the use of the information contained herein, the results of its use, non-infringement, merchantability, or fitness for a particular purpose. Ucamco shall not be liable for any direct, indirect, consequential, or incidental damages arising out of the use or inability to use the information contained herein. You are solely responsible for determining the appropriateness of using this information and assume any risks associated with it.

All product names cited are trademarks or registered trademarks of their respective owners.

## 2 Overview

---

### 2.1 File Structure

The Gerber layer format is a 2D bi-level vector image format: the image is defined by resolution-independent graphical objects. Bi-level or binary images in each point take one of two possible values, typically labeled black and white.

A *single* Gerber file specifies a *single* image. A Gerber file is complete: it does not need sidecar files or external parameters to be interpreted. One Gerber file represents one image. One image needs one file only.

A Gerber file is a *stream of commands*. The commands create a *stream of graphical objects* (see 2.2) that are put on the image plane in order to create the final image. Other commands add attributes to those objects or to the overall file. Attributes are akin to label that add meta information to the objects without affecting the image.

The commands are ordered. A Gerber file can be processed in a single pass. Names, parameters and objects must be defined *before* they are used.

A Gerber file uses printable 7-bit ASCII characters for all commands and names defined in the specification – this fully covers image generation. For attribute values the complete UTF-8 encoding is allowed, as they can be human defined. This makes the files printable and human readable.

Below is a small example Gerber file that creates a circle of 1.5 mm diameter centered on the origin. There is one command per line.

```
%FSLAX26Y26*%  
%MOMM*%  
%ADD100C,1.5*%  
D100*  
X0Y0D03*  
M02*
```

### 2.2 Apertures

An aperture is a 2D plane figure. Aperture typically have simple shapes, as in the examples below, but complex shapes can be created.



Apertures are the basic tools to create graphic images in the plane. They can be replicated in the plane, optionally rotated, mirrored, and scaled. This replication is called flashing, from the days when these things were done with NC optical equipment. Flashes are used to create pads. Apertures can also be used as a pen to draw lines in the plane. This is called interpolating or stroking. Stroking creates traces on the PCB.

There are several methods to define apertures: via standard apertures, macro apertures and block apertures. Apertures are identified by a unique aperture number.

The AD (Aperture Define) command creates an aperture based on an aperture template and parameter values giving it a unique D code or aperture number for later reference.

There are two kinds of apertures templates:

- Standard apertures. They are pre-defined: the circle (C), rectangle (R), obround (O) and regular polygon (P). See 4.4.
- Macro apertures. They are created with the AM (Aperture Macro) command. Any shape and parametrization can be created. They are identified by their given name. (See 4.4.6).

Standard apertures can be considered as built-in macro apertures. The example AD command below creates an aperture. The aperture number is 123. It uses the standard aperture R with parameters 2.5 and 1.5 mm to creates a rectangle of 2.5 by 1.5 mm.

```
%ADD123R, 2.5X1.5%
```

Macros are a powerful feature of the Gerber format. Templates of any shape and parameters can be created. A file writer can easily define the apertures it needs. A file reader can handle any such aperture by implementing a single macro function. This single flexible mechanism replaces the need for a large - but always insufficient - set of built-in apertures. New apertures can be created without extending the format.

Block apertures are an ordered set of graphical objects. Block apertures are not created with templates. They are created by an AB statement, which creates a block aperture with the standard flashes and strokes of the Gerber format, and assigns an aperture number to it (see 2.8).

An aperture has an *origin*. When an aperture is flashed, its origin is positioned at the coordinates in the flash command (see 4.1). The origin of a standard aperture is its geometric center. The origin of a macro aperture is the origin used in the AM command defining the macro. The origin of a block aperture is the origin used in the AB command defining the block.

## 2.3 Graphical objects

A Gerber file creates an ordered stream of graphical objects. A graphical object represents a plane figure. It has a shape, a size, a position and a polarity (dark or clear). The stream of the graphical objects creates the final image by superimposing the objects on the plane in the order of the stream, with dark polarity objects darkening the plane and clear ones erasing all dark areas under them.

There are four types of graphical objects:

- **Draws** are straight-line segments, stroked with the current aperture, which must be a solid circular one.
- **Arcs** are circular segments, stroked with the current aperture, which must be a solid circular one.
- **Flashes** are replications of the current aperture in the image plane. Any valid aperture can be flashed (see 4.8.4). An aperture is typically flashed many times.
- **Regions** are defined by its contour (see 4.10.1). A contour is a closed sequence of connected linear or circular segments.

In PCB copper layers, tracks are typically represented by draws and arcs, pads by flashes and copper pours by regions. Tracks is then a generic name for draws and arcs.

## 2.4 Draws and Arcs

A *draw object* is created by a command with D01 code in linear interpolation mode. The command strokes the straight-line segment with a solid circle standard aperture resulting in a line with thickness equal to the diameter of the circle and round endings.

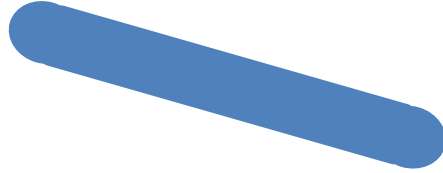

An *arc object* is created by a command with D01 code in circular interpolation mode. In this case the command results in stroking an arc segment with a solid circle standard aperture. The *arc* has round endings, and its thickness is equal to the diameter of the circle. An *arc* object cannot be created using a rectangle or any other aperture.

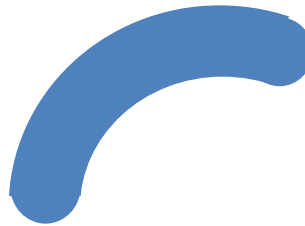

The solid circle *standard* aperture is the only aperture allowed for creating *draw* or *arc* objects. Other standard apertures or macro apertures that fortuitously have a circular shape are not allowed.

A circle aperture with diameter zero can be used for creating a draw or an arc. It creates graphical objects without image which can be used to transfer non-image information, e.g. an outline.

Zero-length draws are allowed. The resulting image is identical to a flash of the same aperture. However the resulting graphical object is a draw and not a flash. Flashes represent pads. Do not try to use zero-length draws to represent pads. Pads must be represented by true flashes."

## 2.5 Operations (D01, D02, D03)

D01, D02 and D03 are the *operations*. An *operation* is a command consisting of coordinate data followed by an operation code. Operations create the graphical objects and/or change the current point by operating on the coordinate data.



### Example:

X100Y100D01\*

X200Y200D02\*

X300Y-400D03\*

The operations have the following effect.

- D02 moves the current point (see 2.5) to the coordinate pair. No graphical object is created.
- D01 creates a linear or circular line segment by interpolating from the current point to the coordinate pair. Outside a region statement (see 2.5) these segments are converted to draw or arc objects by stroking them with the current aperture (see 2.4). Within a region statement these segments form a contour defining a region (see 4.10). The effect of D01, e.g. whether a straight or circular segment is created, depends on the graphics state (see 2.5).
- D03 creates a flash object by flashing (replicating) the current aperture. The origin of the current aperture is positioned at the specified coordinate pair.

## 2.6 Graphics State

The graphics state is a set of parameters affecting the result of the operation codes (see 2.5). Before an operation code is issued all graphics state parameters affecting it must be defined.

The most important graphics state parameter is the *current point*. This is a point in the image plane set implicitly by each operation command (D01, D02, D03) to the coordinates contained in that operation command after finishing.

All other graphics state parameters are set explicitly by corresponding commands. Their values remain constant until explicitly changed.

The table below lists the graphics state parameters. The column 'Constant or variable' indicates whether a parameter remains fixed during the processing of a file or whether it can be changed. The column 'Initial value' is the default value at the beginning of each file; if the default is undefined the parameter value must be explicitly set by a command in the file before it is first used.

Graphics state parameter	Value range	Constant or variable during file processing	Initial value
<b>Coordinate Parameters</b>			
<b>Coordinate format</b>	Coordinate resolution. See the FS command in 4.1	Constant	Undefined
<b>Unit</b>	mm or inch. See MO command in 4.2.1	Constant	Undefined
<b>Generation state</b>			
<b>Current point</b>	Point in plane	Variable	Undefined
<b>Current aperture</b>	Used for interpolating and flashing. See D01 and D03 commands in 4.7	Variable	Undefined
<b>Interpolation state</b>	Linear, clockwise circular, counterclockwise circular. See G01, G02, G03 commands in 4.7	Variable	Undefined
<b>Aperture transformation state</b>			
<b>Polarity</b>	Dark or clear. See the LP command in 4.9.2	Variable	Dark
<b>Mirroring</b>	See the LM command in 4.9.3	Variable	No mirror
<b>Rotation</b>	See the LR command in 4.9.4	Variable	No rotation
<b>Scaling</b>	See the LS command in 4.9.5	Variable	No scaling

*Graphics state parameters*

The graphics state determines the effect of an operation. If a parameter that is required to perform an operation is undefined at the time of the operation the Gerber file is *invalid*. A graphics state parameter that is not needed can remain undefined.

The relevance of the graphics state parameters for the operations is represented in the table below.

Graphics state	Operation codes		
	D01	D02	D03
Coordinate format	Yes	Yes	Yes
Unit	Yes	Yes	Yes
Current point	Yes (interpolation start point)	No	No
	Yes/No refers to the explicit use of the complete current point. If an X and/or Y coordinate is omitted in the operation code the corresponding value from the current point is always taken; this is called modal coordinates.		
Current aperture	Yes outside a region statement. No inside a region statement	No	Yes
Interpolation mode	Yes	No	No
Polarity	Yes	No	Yes
Mirroring	Yes	No	Yes
Rotation	Yes	No	Yes
Scaling	Yes	No	Yes

*Relevance of graphics state parameters for operation codes*

## 2.7 Polarity

The final image of the Gerber file is created by superimposing the objects in the order of their creation. Objects have a polarity, either clear or dark. Objects can overlap. A dark polarity object darkens its image in the plane. A clear polarity object clears its image in *all objects beneath it (generated before)*. Subsequent dark objects may again darken the cleared area. See illustration below. Another example is in 4.10.4.6.

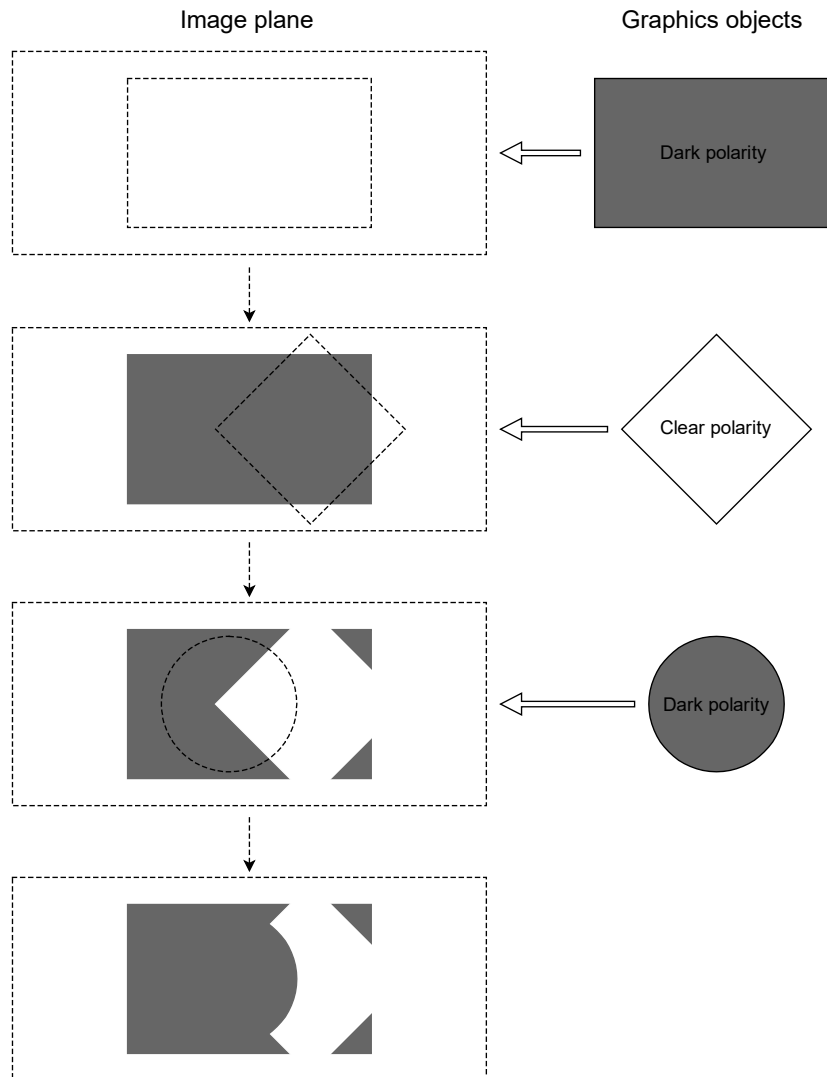

### 1. Superimposing objects with dark and clear polarities

An object is totally dark or totally clear. It cannot be partially dark and partially clear.

The *order* of superimposed objects with different polarities affects the final image.

The LP command sets the polarity mode, a graphics state parameter (see 4.9). Objects that are created when the polarity mode is dark are dark; when the mode is clear the objects are clear.



## 2.8 Blocks

A *block* is a substream of graphical objects that can be added one or more times to the final graphical objects stream. Blocks can be mirrored, rotated, scaled, shifted and its polarity can be toggled. By using blocks sub-images that occur multiple times must only be defined once, thus slashing file size, boosting processing speed and preserving the information that these sub-images are identical.

A block is *not* a macro of commands called repeatedly in the command stream. The command stream is processed sequentially, in one pass, without procedure or macro calls. Gerber is not a programming language.

Blocks can contain objects with different polarities (LPD and LPC). Blocks can overlap.

The origin of the block is the (0, 0) point of the file coordinate space.

Once a block is added to the graphical objects stream its objects become part of the overall stream. Their appearance does not depend on whether they were part of a block or not. Only the order is important. A clear object in a block clears *all* objects beneath it, not only the objects contained in the block.

There are two commands to create a block: SR and AB.

## 2.9 Attributes

Attributes add meta-information to a Gerber file. These are akin to labels providing additional information about the file or features within. Examples of such meta-information are:

- The function of the file: is it the top solder mask, or the bottom copper layer etc.
- The function of a pad: is the pad a component pad, or a via pad, or a fiducial, etc.



Example:

This command defines an attribute indicating the file represents the top solder mask.

```
%TF.FileFunction,Soldermask,Top*%
```

Attributes can be attached to objects, apertures or to the complete file.

Attributes do not affect the image itself, they only add meta-information to the data. A Gerber reader will generate the correct image even if it ignores some or all attributes.

The attribute syntax provides a flexible and standardized way to add meta-information to the images, independent of the specific semantics or application.

Attributes are needed when PCB data is transferred from design to fabrication. The PCB fabricator needs more than just the image. For example, the solder mask around via pads needs dedicated clearances to achieve the specified via protection. Without these attributes, the fabricator has to guess which objects represent a via; figuring this out manually is a time consuming and error-prone process. The attributes transfer the design intent from CAD to CAM in an unequivocal and standardized manner. This is sometimes rather grandly called “adding intelligence to the image”.

Gerber files containing attribute commands (TF, TA, TO, TD) are called Gerber X2 files, files without attributes Gerber X1 files.

Attributes are described in detail in the chapter 5.

## 2.10 Commands Overview

Command	Long name	Description	Ref.
G04	Comment	A human readable comment, does not affect the image.	4.1
MO	Mode	Sets the unit to mm or inch.	4.2.1
FS	Format specification	Sets the coordinate format, e.g. the number of decimals.	4.2.2
AD	Aperture define	Defines a template-based aperture, assigns a D code to it.	4.3
AM	Aperture macro	Defines a macro aperture template.	4.5
Dnn (nn≥10)		Sets the current aperture to D code nn.	4.6
D01	Interpolate operation	Outside a region statement D01 creates a draw or arc object with the current aperture. Inside it adds a draw/arc segment to the contour under construction. The current point is moved to draw/arc end point after the creation of the draw/arc.	4.8.2
D02	Move operation	D02 moves the current point to the coordinate in the command. It does not create an object.	4.8.3
D03	Flash operation	Creates a flash object with the current aperture. The current point is moved to the flash point.	4.8.4
G01		Sets linear/circular mode to linear.	4.7.1
G02		Sets linear/circular mode to clockwise circular.	4.7.2
G03		Sets linear/circular mode to counterclockwise circular.	4.7.2
G75		A G75 must be called before creating the first arc.	4.7.2
LP	Load polarity	Loads the polarity object transformation parameter.	4.9.2
LM	Load mirroring	Loads the mirror object transformation parameter.	4.9.3
LR	Load rotation	Loads the rotation object transformation parameter.	4.9.4
LS	Load scaling	Loads the scale object transformation parameter.	4.9.5
G36		Starts a region statement which creates a region by defining its contours.	4.10.
G37		Ends the region statement.	4.10
AB	Aperture block	Opens a block aperture statement and assigns its aperture number or closes a block aperture statement.	4.11
SR	Step and repeat	Open or closes a step and repeat statement.	4.11
TF	Attribute on file	Set a file attribute.	5.2
TA	Attribute on aperture	Add an aperture attribute to the dictionary or modify it.	5.3
TO	Attribute on object	Add an object attribute to the dictionary or modify it.	5.4
TD	Attribute delete	Delete one or all attributes in the dictionary.	5.5
M02		End of file.	4.13

### Command Overview

## 2.11 Processing a Gerber File

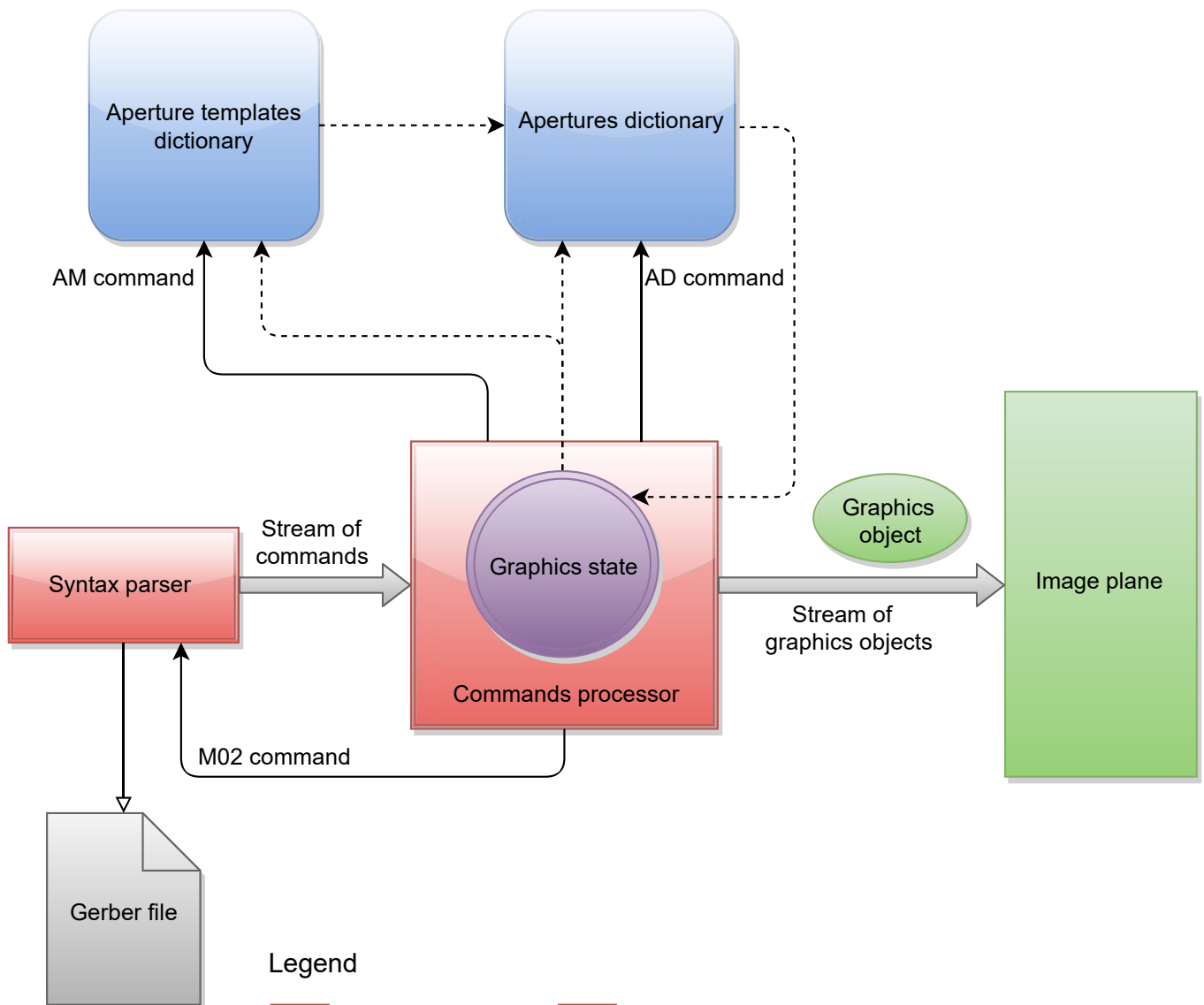

### Legend

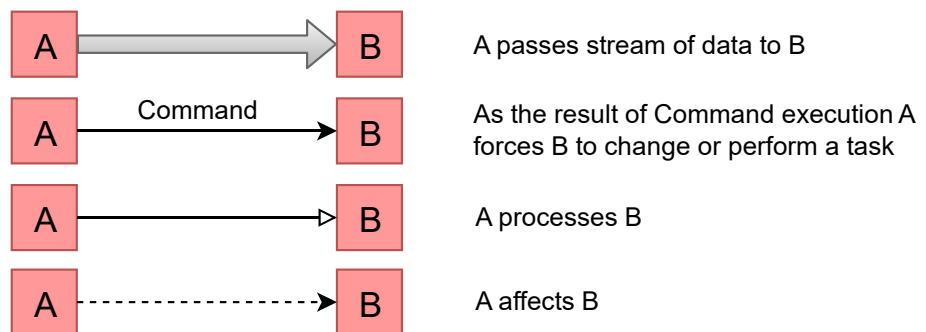

### 2. Gerber file processing diagram

The syntax parser reads the Gerber file and produces the stream of commands for the commands processor. The commands processor is responsible for handling the stream of

commands and as the result it generates the stream of graphical objects. All the created objects are superimposed on the image plane in order of their creation.

The *graphics state* is a core part of the command processor. How the processor creates graphical objects from the operation codes (see 2.5) depends on the graphics state. Conversely, the processor modifies the graphics state when processing certain commands (see 2.5).

The aperture template dictionary holds all the templates available. The AD command (see 4.3) instantiates the templates to apertures and adds them to the aperture library. Standard, or built-in, aperture templates are automatically added to the dictionary when file processing is started. Macro aperture templates are created with an AM command (see 4.5); they are added when the AM command is processed.

The *current aperture* is a graphics state parameter that is maintained by Dnn command (see 4.6). When the processor executes a Dnn command a referenced aperture from apertures dictionary is set as the current aperture.

The graphics state also affects the generation of aperture templates and apertures: the templates and apertures depend on 'coordinate format' and 'unit' graphics state parameters (see 2.5).

The graphical object stream is without state. Objects are superimposed as they are, in their order of appearance.

After processing the M02 command (see 4.13) the processor interrupts the syntax parser and stops the graphical objects generation.

The image from above illustrates the processing of a Gerber file without attributes.

## 2.12 Glossary

**AB statement:** A statement defining a block aperture.

**Aperture:** A 2D shape that is used for stroking or flashing. (The name is historic; vector photoplotters exposed images on lithographic film by shining light through an opening, called aperture.) They are identified by an aperture number.

**Aperture macro:** The content of an Aperture Macro (AM) command. Defines a custom aperture template by combining built-in primitives.

**Aperture template:** A template is used to create the specific apertures used in the file. The AD command defines the parameters to instantiate the template to a defined aperture. There are three types of templates: standard or built-in apertures, macro apertures and block apertures.

**Aperture templates dictionary:** The object that holds all the aperture templates.

**Apertures dictionary:** The object that holds all the apertures.

**Arc:** A graphical object created by a D01 command in a circular interpolation mode.

**Attribute:** Metadata that is attached to the file or to objects in it; it provides extra information without affecting the image.

**Attributes dictionary:** The object that holds all the current attributes during the processing of a Gerber file.

**Bi-level image:** A two-dimensional (2D) image represented by two colors, usually black and white.

**Block:** A substream of graphical objects that can be added to the final objects stream.

**Circular interpolation:** Creating a circular segment (circular arc) that is either an arc graphical object or used as a circular contour segment.

**Clear:** Clearing or erasing part of the image in the image plane. When a graphical object with clear polarity is added to the stream it erases its shape from any image that was already there.

**Command:** Commands are the basic unit of a Gerber file. Commands create graphical objects, define apertures, manage attributes, modify the graphics state and so on. For historic reasons, there are two syntax styles for commands: word commands and extended commands.

**Command code:** A code that identifies the command.

**Contour:** A closed sequence of connected linear or circular segments. Contours are used to create regions or outline primitives in macro apertures.

**Coordinate data:** A number whose interpretation is determined by the FS command. It is used to specify the X and Y coordinates of a point in the image plane and a distance or offset in the X and Y direction.

**Coordinate format:** The specification of how to convert coordinate data to coordinates. It is file-dependent and is defined by an FS command.

**Current aperture:** The graphics state parameter that specifies the last aperture selected by a Dnn command. The current aperture is always used to create flashes, draws and arcs.

**Current point:** The graphics state parameter that specifies the point in the plane used as a begin point of a circular or linear interpolation or as the location flash.

**Darken:** Darken the shape of a graphical object on the image plane; this happens when a graphical object with dark polarity added to the image.

**Draw:** A graphical object created by D01 command in linear interpolation mode.

**File image:** The bi-level image that is the visual representation of a Gerber file. It is created by superimposing the graphical objects in the plane.

**Flash:** A graphical object created by D03 or flash command.

**Gerber file:** A file in the Gerber format.

**Gerber format:** The vector image format defined by the current specification and used for representing a bi-level image.

**Graphical object:** A graphical object is a 2D object with a shape, a size, a position in the plane and a polarity (dark or clear). It is of one of the following types: flash, draw, arc or region. The file image is created by superimposing graphical objects on the image plane. Attributes can optionally be attached to a graphical object.

**Graphics state:** The set of parameters that at each moment determine how the operation codes create graphical objects. For example, it determines whether a D01 operation code creates a draw or an arc.

**Header:** The part of the file from the file beginning to the point where the first operation code is encountered. The header typically holds the definitions of file attributes, aperture definitions, scale and unit.

**Image plane:** The 2D plane in which the image defined by the file is created.

**Interpolation mode:** The graphics state parameter defining how the D01 operation behaves.

**Linear interpolation:** Creating a straight segment that is either converted to a draw graphical object or used as a linear contour segment.

**Macro aperture:** An aperture template defined using AM command.

**Operation:** A command containing one of the operation codes D01, D02 or D03 and coordinate data. The operation code defines the type of the operation that is performed with the coordinate data. Operations may create graphical objects, create contours, and change the current point of the graphics state.

**Polarity:** A graphics state parameter that can take the value dark or clear. It determines the polarity of the graphical objects generated. Dark means that the object marks the image plane in dark and clear means that the object clears or erases everything underneath it. See also 'Darken' and 'Clear'.

**Region:** A graphical object with an arbitrary shape defined by its contour.

**Region statement:** A statement creating a region by defining its contour.

**Resolution:** The distance expressed by the least significant digit of coordinate data. Thus, the resolution is the step size of the grid on which all coordinates are defined.

**SR statement:** A statement defining a block and step & repeating it.

**Standard aperture:** A built-in aperture template.

**Standard attribute:** A built-in attribute with a pre-defined semantics. See also user attribute.

**Statement:** A coherent sequence of commands delimited by an open and close command defining a higher-level structure.

**Stroke:** To create a draw or an arc graphical object with the current aperture.

**Track:** Either a draw or an arc. Typically used for conductive traces on a PCB.

**Unit:** The measurement unit 'mm' or 'inch' used to interpret the coordinate data. The effective unit is stored as the value of the corresponding graphics state parameter.

**User attribute:** A third-party defined attribute to extend the format with proprietary meta-information.

**Word:** A sequence of characters ending with the '\*' delimiter character. It is the low-level syntactical element of a Gerber file used to build commands.

## 2.13 Annotated Example Files

These annotated sample files illustrate the Gerber layer format to make the formal specification easier to read.

### 2.13.1 Example: Two Square Boxes

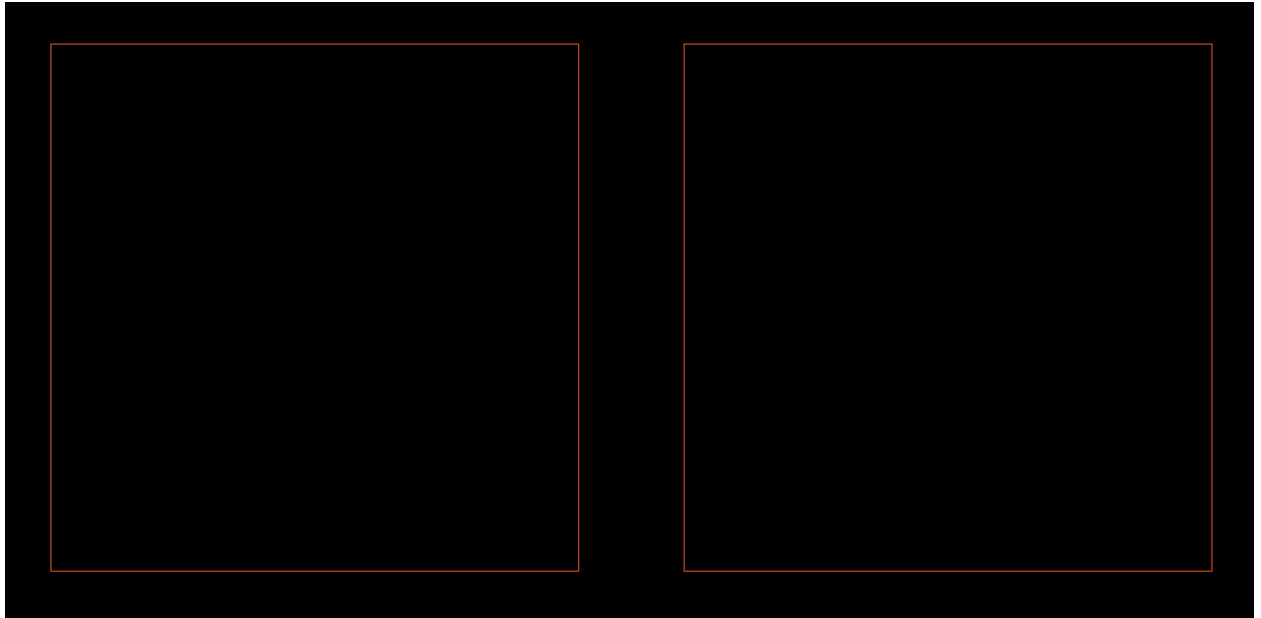

3. Example: two square boxes

Syntax	Annotation
G04 Ucamco ex. 1: Two square boxes*	A comment
%MOMM*%	Unit set to mm
%FSLAX26Y26*%	Format specification: Leading zero's omitted Absolute coordinates Coordinates in 3 integer and.6 fractional digits.
%TF.Part,Other,example*%	Attribute: the file does not describe a PCB part - it is just an example
%LPD*%	Set the polarity to dark
%ADD10C,0.010*%	Define aperture number 10 as a 0.01 mm circle
D10*	Select aperture 10 as current aperture
X0Y0D02*	Set current point to (0, 0)
G01*	Set linear interpolation mode
X5000000Y0D01*	Create draw graphical object with the current aperture (10): start point is the current point (0,0), end point is (5, 0)
Y5000000D01*	Create draw with the current aperture: (5, 0) to (5, 5)
X0D01*	Create draw with the current aperture: (5, 5) to (0, 5)
Y0D01*	Create draw with the current aperture: (0, 5) to (0, 0)



Syntax	Annotation
X6000000D02*	Set current point to (6, 0)
X11000000D01*	Create draw with the current aperture: (6, 0) to (11, 0)
Y5000000D01*	Create draw with the current aperture: (11, 0) to (11, 5)
X6000000D01*	Create draw with the current aperture: (11, 5) to (6, 5)
Y0D01*	Create draw with the current aperture: (6, 5) to (6, 0)
M02*	End of file

## 2.13.2 Example: Polarities and Apertures

This example illustrates the use of polarities and various apertures.



### 4. Example: various shapes

Syntax	Annotation
G04 Ucamco ex. 2: Shapes*	A comment
G04 Ucamco ex. 2: Shapes*	Comment
%MOMM*%	Units are mm
%FSLAX36Y36*%	Format specification: Leading zero's omitted Absolute coordinates Coordinates in 3 integer and 6 fractional digits.
%TF.FileFunction,Other,Sample*	Attribute: the is not a PCB layer, it is just an example
G04 Define Apertures*	Comment

Syntax	Annotation
%AMTHERMAL80*	Define the aperture macro 'THERMAL80'
7,0,0,0.800,0.550,0.125,45*%	Use thermal primitive in the macro
%ADD10C,0.1*%	Define aperture 10 as a circle with diameter 0.1 mm
%ADD11C,0.6*%	Define aperture 11 as a circle with diameter 0.6 mm
%ADD12R,0.6X0.6*%	Define aperture 12 as a rectangle with size 0.6 x 0.6 mm
%ADD13R,0.4X1.00*%	Define aperture 13 as a rectangle with size 0.4 x 1 mm
%ADD14R,1.00X0.4*%	Define aperture 14 as a rectangle with size 1 x 0.4 mm
%ADD15O,0.4X01.00*%	Define aperture 15 as an obround with size 0.4 x 1 mm
%ADD16P,1.00X3*%	Define aperture 16 as a polygon with 3 vertices and circumscribed circle with diameter 1 mm
%ADD19THERMAL80*%	Define aperture 19 as an instance of macro aperture 'THERMAL80' defined earlier
G04 Start image generation*	A comment
D10*	Select aperture 10 as current aperture
X0Y2500000D02*	Set the current point to (0, 2.5) mm
G01*	Set linear interpolation mode
X0Y0D01*	Create draw with the current aperture
X2500000Y0D01*	Create draw with the current aperture
X10000000Y10000000D02*	Set the current point
X15000000D01*	Create draw with the current aperture
X20000000Y15000000D01*	Create draw with the current aperture
X25000000D02*	Set the current point.
Y10000000D01*	Create draw with the current aperture
D11*	Select aperture 11 as current aperture
X10000000Y10000000D03*	Create flash with the current aperture (11) at (10, 10).
X20000000D03*	Create a flash with the current aperture at (20, 10). Y is modal.
X25000000D03*	Create a flash with the current aperture at (25, 10). Y is modal.
Y15000000D03*	Create a flash with the current aperture at (25, 15). X is modal.
X20000000D03*	Create a flash with the current aperture at (20, 15). Y is modal.
D12*	Select aperture 12 as current aperture
X10000000Y15000000D03*	Create a flash with the current aperture at (10, 15)
D13*	Select aperture 13 as current aperture
X30000000Y15000000D03*	Create a flash with the current aperture at (30, 15)

Syntax	Annotation
D14*	Select aperture 14 as current aperture
Y12500000D03*	Create a flash with the current aperture at (30, 125)
D15*	Select aperture 14 as current aperture
Y10000000D03*	Create a flash with the current aperture at (30, 10)
D10*	Select aperture 10 as current aperture
X37500000Y10000000D02*	Set the current point
G75*	Must be called before an arc is created
G03*	Set counterclockwise circular interpolation mode
X37500000Y10000000I2500000J0D01*	Create full circular arc with the current aperture (10).
D16*	Set the current aperture: use aperture 16
X34000000Y10000000D03*	Create a flash with the current aperture 16
X35000000Y90000000D03*	Create a flash with the current aperture 16 again
G36*	Start a region statement
X5000000Y20000000D02*	Set the current point to (5, 20)
G01*	Set linear interpolation mode
Y37500000D01*	Create linear segment of the contour
X37500000D01*	Create linear segment of the contour
Y20000000D01*	Create linear segment of the contour
X50000000D01*	Create linear segment of the contour
G37*	Close the region statement. This creates the region by filling the created contour
%LPC*%	Set the polarity to clear
G36*	Start the region statement
X10000000Y25000000D02*	Set the current point to (10, 25)
Y30000000D01*	Create linear segment
G02*	Set clockwise circular interpolation mode
X12500000Y32500000I2500000J0D01*	Create clockwise circular segment with radius 2.5
G01*	Set linear interpolation mode
X30000000D01*	Create linear segment
G02*	Set clockwise circular interpolation mode
X30000000Y25000000I0J-37500000D01*	Create clockwise circular segment with radius 3.75
G01*	Set linear interpolation mode
X10000000D01*	Create linear segment
G37*	Close the region statement, creates region object
%LPD*%	Set the polarity to dark

Syntax	Annotation
D10*	Select aperture 10 as current aperture
X15000000Y28750000D02*	Set the current point
X20000000D01*	Create draw with the current aperture
D11*	Select aperture 11 as current aperture
X15000000Y28750000D03*	Create a flash with the current aperture (11)
X20000000D03*	Create a flash with the current aperture
D19*	Select aperture 19 as current aperture
X28750000Y28750000D03*	Create a flash with the current aperture (19)
M02*	End of file

## 2.14 Conformance

A file violating any requirement of the specification or with constructs not defined in it is wholly invalid. An invalid Gerber file is meaningless and does *not* represent an image.

A conforming Gerber file writer must write files according to this specification. A current conforming Gerber file writer cannot use deprecated constructs. A writer is not required to consider limitations or errors in particular readers but may assume that a valid file will be processed correctly.

A conforming Gerber file reader must render a valid Gerber file according to this specification. A current reader may support deprecated format elements as they can be present in legacy files. To prepare for future extensions of the format, a Gerber file reader *must* give a warning when encountering an unimplemented command, skip it and continue processing. Otherwise there is *no* mandatory behavior on reading an invalid Gerber file. It is *not* mandatory to report any other errors – this would impose an unreasonable burden on readers and may result in useless messages in some applications. A reader is allowed to attempt to reverse engineer the intended image and display it; note that if reverse engineering fails this is the responsibility of the writer of the file, not the reader, as the invalid file is meaningless – it is the file that is wrong, not the reader.

The responsibilities are obvious and plain. Writers must write valid and numerically robust files and readers must process such files correctly. Writers are not responsible to navigate around problems in the readers, nor are readers responsible to solve problems in the writers. Keep in mind Postel's rule: "*Be conservative in what you send, be liberal in what you accept.*"

Standard Gerber (RS-274-D) is revoked and therefore non-conforming. The responsibility for misunderstandings of its non-standardized wheel file rests solely with the party that decided to use Standard Gerber rather than Extended Gerber. See 8.5.

This document is the sole specification of the Gerber format. Gerber viewers, however useful, do not overrule this document.

## 3 Syntax

---

### 3.1 Character Set

A Gerber file is expressed in UTF-8 Unicode. The line separators CR and LF can be ignored when processing the file, their sole purpose is human readability. The Gerber file is therefore human-readable and transferrable between systems.

The characters '\*' and '%' are delimiters and can only be used as prescribed in the syntax. Space characters are *only* allowed inside strings (see 3.4.3).

Gerber files are case-sensitive. Command codes must be in upper case.

Actually, *except for user defined attribute values*, all characters in a Gerber file restricted to the readable ASCII characters, with codes 32 to 126, and new line characters. User defined meta-data may require special characters such as  $\mu$  or may be in other languages than English; hence UTF-8 Unicode is allowed.

### 3.2 Grammar Syntax

The formal grammar used in this specification is the parsing expression grammar (PEG), similar in formalism to context-free grammars, with a slightly different interpretation. See [https://en.wikipedia.org/wiki/Parsing\\_expression\\_grammar](https://en.wikipedia.org/wiki/Parsing_expression_grammar) for more information. The grammar of is expressed in the variant of the Extended Backus-Naur Form used by the TatSu PEG parser generator. <https://tatsu.readthedocs.io/en/stable/> for more information. Only a subset of the rules in the very powerful TatSu grammar is needed – after all Gerber is a simple format. Below is a description of that subset, taken from the TatSu documentation.

A grammar consists of a sequence of one or more rules of the form:

**name = <expression> ;**

The expressions are constructed from the following operators, in reverse order of precedence.

Grammar Syntax Rules		
Rule	Name	Description
#	Comment	Comments have no effect on the grammar.
<b>e1   e2</b>	Choice	Match either <b>e1</b> or <b>e2</b> A   can be used before the first option as a layout aid: <b>rule =</b>   <b>option1</b>   <b>option2</b>   <b>option3</b> ;
(e)	Grouping	Match <b>e</b> , making it a node in the syntax tree
[e]	Option	Optionally match <b>e</b>
{e} or {e}*	Closure	Match <b>e</b> zero or more times.
{e}+	Positive closure	Match <b>e</b> one or more times.
&e	Positive lookahead	Succeeds if <b>e</b> can be parsed. Does not consume input
!e	Negative lookahead	Fails if <b>e</b> can be parsed. Does not consume input
'text'	Token	Match the token <i>text</i> . If <i>text</i> is alphanumeric it will only parse if the character following the token is not alphanumeric. This is done to prevent tokens like <i>IN</i> matching when the text ahead is <i>INITIALIZE</i> . This feature can be turned off by setting the grammar directive <b>@@nameguard=False</b>
/regexp/	Regex	The pattern expression. Match the regular expression <b>regexp</b> at the current text position. Python style regex is used, and it is interpreted as a Python raw string.
\$	End-of-text	Verify that the end of the input text has been reached.
~	Cut	Commit to the current option and prevent other options from being considered even if what follows fails to parse.



Grammar Directives	
Directive	Description
<code>@@grammar :: &lt;word&gt;</code>	Specifies the name of the grammar.
<code>@@nameguard :: &lt;bool&gt;</code>	When set to True, avoids matching tokens when the next character in the input sequence is alphanumeric. Defaults to True. See the 'text' expression for an explanation. <b>@@nameguard :: False</b>
<code>@@whitespace :: &lt;regex&gt;</code>	Provides a regular expression for the whitespace to be ignored by the parser. It defaults to <code>/(\s)+/</code> <b>@@whitespace :: /[\t ]+</b>

## 3.3 Commands

Commands are the core syntactic element of the Gerber format. A Gerber file is a stream of commands. Commands define the graphics state, create graphical objects, defines apertures, manage attributes and so on.

Commands are built with *words*, the basic syntactic building block of a Gerber file. A word is a non-empty character string, excluding the reserved characters '\*' and '%', terminated with an '\*'

```
free_character = /^[^%*]/; # All characters but * and %
word          = {free_character}+ '*';
```

For historic reasons, there are two command syntax styles: word commands and extended commands.

```
command =
  | extended_command
  | word_command
  ;
word_command = word;
extended_command = '%' {word}+ '%';
```

Word commands are identified by a command code, the letter G, D or M followed by a positive integer, e.g. G02. Most word commands only consist of the command code, some also contain coordinates.

Extended commands are identified by a two-character command code that is followed by parameters specific to the code. An extended command is enclosed by a pair of '%' delimiters.

An overview of all commands is in section 2.10, a full description in chapters 3.5 and 5.

The example below shows a stream of Gerber commands. Word commands are in yellow, extended commands in green.



### Example:

```
G04 Different command styles*
%FSLAX26Y26*%
%MOMM*%
%AMDonut*
1,1,$1,$2,$3*
$4=$1x0.75*
```

```
1, 0, $4, $2, $3*  
%  
%ADD11Donut, 0.30X0X0*%  
%ADD10C, 0.1*%  
D10*  
G75*  
G02*  
X0Y0D02*  
X2000000Y0I0Y1000000D01*  
G01*  
D11*  
D03*  
M02*
```

One of the strengths of the Gerber format is its human readability. Use line breaks to enhance readability; put one word or command per line; do not put a new line within a word, except after a comma in long words.

## 3.4 Data Types

All data types are tokens in the Gerber syntax, expressed a regex.

### 3.4.1 Integers

Integers must fit in a 32-bit signed integer. Examples:

```
0
-1024
+16
```

```
unsigned_integer = /[0-9]+/;
positive_integer = /[0-9]*[1-9][0-9]*/;
integer          = /[+-]?[0-9]+/;
```

### 3.4.2 Decimals

Decimals must fit in an IEEE double. Examples:

```
-200
5000
1234.56
.123
-0.128
0
```

```
unsigned_decimal = ((([0-9]+)(\.[0-9]*)?)(\.[0-9]+));
decimal          = /[+-]?((([0-9]+)(\.[0-9]*)?)(\.[0-9]+));
```

Note that a standalone comma ',' is *not* a valid decimal point.

### 3.4.3 Strings

Strings are used for communication between humans and can contain other characters than ASCII. These are expressed by UTF-8 literal characters, or by a Unicode escape. Note that reserved characters *must* be escaped.

```
string = /^[^%]*/; # All characters except %
```

Note that UTF-8 is identical to ASCII for any character that can be represented by ASCII.

The Unicode escape for the copyright symbol '©' is as follows:

- With lower case u for a 16-bit hex value: `\u00A9`
- With upper case U for a 32-bit hex value: `\U000000A9`

Zero-fill if needed to reach the required 4 or 8 hex digits

- The reserved characters '%' (`\u0025`) and '\*' (`\u002A`) must *always* be escaped as they are the delimiters of the Gerber syntax.
- '\' (`\u005C`) must be escaped as it is the escape character.
- ',' (`\u002C`) separates fields, and therefore must be escaped in any string that does not end the word.

Any character may be escaped. Escape every non-ASCII character if you need to keep a file ASCII-only. This may increase compatibility with legacy software but defeats human readability of the meta-data.

If you want to keep the Gerber file printable ASCII-only use escape sequences for any character in strings or fields. This may increase compatibility with legacy software but defeats human readability of the meta-data.

### 3.4.4 Fields

The fields follow the string syntax in section 3.4.3 with the additional restriction that a field must not contain commas. Fields are intended to represent comma-separated items in strings. A comma can be escaped with \u002C.

**field = /^[^%\*,]\*/; # All characters except \*%,**

### 3.4.5 Names

Names identify something, such as an attribute. They are for use only within the Gerber format and are therefore limited to printable ASCII.

Names consist of upper- or lower-case ASCII letters, underscores ('\_'), dots ('.'), a dollar sign ('\$') and digits. The first character *cannot* be a digit. Names are from 1 to 127 characters long. Names beginning with a dot '.' are reserved for *standard names* defined in the specification. User defined names *cannot* begin with a dot.

**Name = [.\_\$a-zA-Z][.\_\$a-zA-Z0-9]{0,126}**

**StandardName = \.[.\_\$a-zA-Z][.\_\$a-zA-Z0-9]{0,125}**

**UserDefinedName = [.\_\$a-zA-Z][.\_\$a-zA-Z0-9]{0,126}**

The scope of a name is from its definition till the end of the file. Names are case-sensitive.

Names for macro variables used in AM commands are more restrictive. They are of the form \$n, with n a positive integer, for example \$3.

## 3.5 Full Grammar of the Gerber Format

```
@@grammar  :: Gerber_2021_02  
@@nameguard :: False  
@@whitespace :: /\n/
```

```
start = {statement}* M02 $;  
statement =  
  | single_statement  
  | compound_statement  
  ;
```

```
single_statement =  
  | operation  
  | interpolation_state_command  
  | Dnn  
  | G04  
  | attribute_command  
  | AD  
  | AM  
  | coordinate_command  
  | transformation_state_command  
  ;
```

```
compound_statement =  
  | region_statement  
  | SR_statement  
  | AB_statement  
  ;
```

```
coordinate_command =  
  | FS  
  | MO  
  ;
```

```
operation =  
  | D01  
  | D02  
  | D03  
  ;
```

```
interpolation_state_command =  
  | G01  
  | G02  
  | G03  
  | G75  
  ;
```

**transformation\_state\_command =**

|LP

|LM

|LR

|LS

;

**attribute\_command =**

|TO

|TD

|TA

|TF

;

**# Graphics commands**

**#-----**

**FS = '%' ('FS' 'LA' 'X' coordinate\_digits 'Y' coordinate\_digits) '\*\*%';**

**coordinate\_digits = /[1-6][56]/;**

**MO = '%' ('MO' ('MM'|'IN')) '\*\*%';**

**D01 = (['X' integer] ['Y' integer] ['I' integer 'J' integer] 'D01') '\*\*;**

**D02 = (['X' integer] ['Y' integer] 'D02') '\*\*;**

**D03 = (['X' integer] ['Y' integer] 'D03') '\*\*;**

**G01 = ('G01') '\*\*;**

**G02 = ('G02') '\*\*;**

**G03 = ('G03') '\*\*;**

**G75 = ('G75') '\*\*;**

**Dnn = (aperture\_ident) '\*\*;**

**G04 = ('G04' string) '\*\*;**

**M02 = ('M02') '\*\*;**

**LP = '%' ('LP' ('C'|'D')) '\*\*%';**

**LM = '%' ('LM' ('N'|'XY'|'Y'|'X')) '\*\*%';**

**LR = '%' ('LR' decimal) '\*\*%';**

**LS = '%' ('LS' decimal) '\*\*%';**

**AD = '%' ('AD' aperture\_ident template\_call) '\*\*%';**

**#aperture\_shape = name [, ' decimal {'X' decimal}\*];**

**template\_call =**

```
|'C' fst_par [nxt_par]
|R' fst_par nxt_par [nxt_par]
|'O' fst_par nxt_par [nxt_par]
|'P' fst_par nxt_par [nxt_par [nxt_par]]
|!(('C'|'R'|'O'|'P')(',')|'**') name [fst_par {nxt_par}*]
;
fst_par = ',' (decimal);
nxt_par = 'X' (decimal);
```

```
AM = '%' ('AM' macro_name macro_body) '%';
macro_name = name '**';
macro_body = {in_macro_block}+;
in_macro_block =
    |primitive
    |variable_definition
;
variable_definition = (macro_variable '=' expression) '**';
macro_variable = '$' positive_integer;
primitive =
    |('0' string) '**
    |('1' par par par par [par]) '**
    |('20' par par par par par par par) '**
    |('21' par par par par par par par) '**
    |('4' par par par par {par par}+ par) '**
    |('5' par par par par par par par) '**
    |('7' par par par par par par par) '**
;
par = ',' (expression);
```

## # Compound statements

```
region_statement = G36 {contour}+ G37;
contour = D02 {D01|interpolation_state_command}*;
G36 = ('G36') '**';
G37 = ('G37') '**';
```

```
AB_statement = AB_open {in_block_statement}* AB_close;
AB_open = '%' ('AB' aperture_ident) '**%';
AB_close = '%' ('AB') '**%';
```

```
SR_statement = SR_open {in_block_statement}* SR_close;
SR_open = '%' ('SR' 'X' positive_integer 'Y' positive_integer 'I' decimal 'J'
decimal) '**%';
```

```
SR_close = '% ('SR') '*%';
```

```
in_block_statement =  
  |single_statement  
  |region_statement  
  |AB_statement  
  ;
```

## # Attribute commands

```
#-----
```

```
TF = '% ('TF' TF_atts) '*%';  
TA = '% ('TA' TA_atts) '*%';  
TO = '% ('TO' TO_atts) '*%';  
TD = '% ('TD' [all_atts]) '*%';
```

```
TF_atts =
```

```
  |'.Part'                {nxt_field}*  
  |'.FileFunction'        {nxt_field}*  
  |'.FilePolarity'        nxt_field  
  |'.SameCoordinates'     [nxt_field]  
  |'.CreationDate'        nxt_field  
  |'.GenerationSoftware'  nxt_field nxt_field [nxt_field]  
  |'.ProjectId'           nxt_field nxt_field nxt_field  
  |'.MD5'                 nxt_field  
  |user_name  
  ;
```

```
TA_atts =
```

```
  |'.AperFunction' {nxt_field}*  
  |'.DrillTolerance' nxt_field nxt_field  
  |'.FlashText'    {nxt_field}*  
  |user_name       {nxt_field}*  
  ;
```

```
TO_atts =
```

```
  |'.N'  nxt_field {nxt_field}*  
  |'.P'  nxt_field nxt_field [nxt_field]  
  |'.C'  nxt_field  
  |'.CRot' nxt_field  
  |'.CMfr' nxt_field  
  |'.CMPN' nxt_field  
  |'.CVal' nxt_field  
  |'.CMnt' nxt_field  
  |'.CFtp' nxt_field
```



```
|.CPgN' nxt_field
|.CPgD' nxt_field
|.CHgt' nxt_field
|.CLbN' nxt_field
|.CLbD' nxt_field
|.CSup' nxt_field nxt_field {nxt_field nxt_field}*
|user_name {nxt_field}*
;
all_atts =
|TF_atts
|TA_atts
|TO_atts
;
nxt_field = ',' field;

# Expressions
#-----

expression =
|{addsub_operator term}+
|expression addsub_operator term
|term
;
term =
|term muldiv_operator factor
|factor
;
factor =
| '(' ~ expression ')'
|macro_variable
|unsigned_decimal
;

# Tokens, by regex
#-----

addsub_operator = /[+ -]/;
muldiv_operator = /[xV]/;

unsigned_integer = /[0-9]+/;
positive_integer = /[0-9]*[1-9][0-9]*/;
integer = /[+ -]?[0-9]+/;
unsigned_decimal = /((( [0-9]+ )(\.[0-9]*)? )(\.[0-9]+) )/;
```

**decimal** = /[+-]?((((0-9)+(\.[0-9]\*)?)(\.[0-9]+));

**aperture\_ident** = /D[0-9]{2,}/;

**name** = /[\_a-zA-Z][\_a-zA-Z0-9]\*/;

**user\_name** = /[\_a-zA-Z][\_a-zA-Z0-9]\*/; # Cannot start with a dot

**string** = /[^%]\*/; # All characters except \* %

**field** = /[^%\*,]\*/; # All characters except \* % ,

## 3.6 File Extension, MIME Type and UTI

The Gerber Format has a standard file name extension, a registered mime type and a UTI definition.

**Standard file extension:** .gbr or .GBR

**Mime type:** application/vnd.gerber

(see <http://www.iana.org/assignments/media-types/application/vnd.gerber>)

**Mac OS X UTI:**

```
<key>UTExportedTypeDeclarations</key>
<array>
  <dict>
    <key>UTTypeIdentifier</key>
    <string>com.ucamco.gerber.image</string>
    <key>UTTypeReferenceURL</key>
    <string>http://www.ucamco.com/gerber</string>
    <key>UTTypeDescription</key>
    <string>Gerber image</string>
    <key>UTTypeConformsTo</key>
    <array>
      <string>public.plain-text</string>
      <string>public.image</string>
    </array>
    <key>UTTypeTagSpecification</key>
    <dict>
      <key>public.filename-extension</key>
      <array>
        <string>gbr</string>
      </array>
      <key>public.mime-type</key>
      <string>application/vnd.gerber</string>
    </dict>
  </dict>
</array>
```

## 4 Graphics

---

### 4.1 Comment (G04)

The G04 command is used for human readable comments. It does not affect the image. The syntax for G04 is as follows.

**G04 = ('G04' string) '\*';**

The string must follow the string syntax in 3.4.3.



**Example:**

```
G04 This is a comment*
```

```
G04 The space characters as well as ', ' and '; ' are allowed here.*
```

Content starting with "**#@!**" is reserved for *standard comments*. Standard comments can only be used if defined in the specification. Their purpose is to allow to add meta-information without affecting image generation. Gerber readers must ignore such comments for image generation.

## 4.2 Coordinate Commands

The Gerber Layer Format uses 2D Cartesian coordinates. When the PCB is viewed from the top towards the bottom layer the X axis points to the right then the Y axis points upwards as in the illustration below.

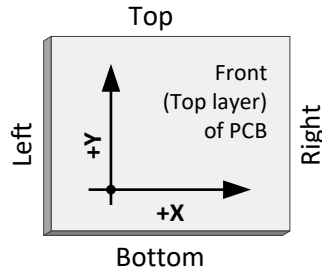

The origin of the system and its orientation can be chosen freely, but it is recommended to put the origin on the bottom left corner of the PCB and orient the X-axis along the bottom edge whenever possible. The same coordinate system *must* always be used for all layers, in other words objects on different that align in the real world *must* have the same coordinates. See illustration.

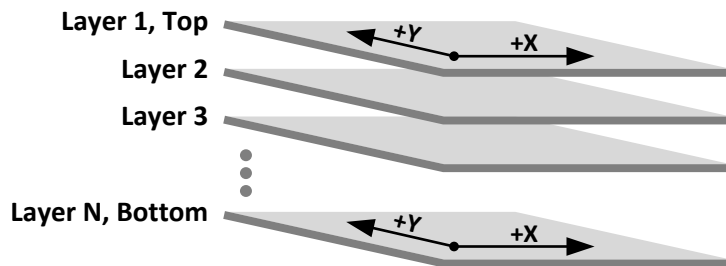

Positive rotation is counterclockwise when viewed from top towards bottom layer.



### 4.2.1 Unit (MO)

The MO (Mode) command sets the file unit to either metric (mm) or imperial (inch).

The MO command must be used once and only once, in the header of the file, before the first operation command. The syntax is:

**MO = '%' ('MO' ('MM'|'IN')) '\*%';**

Syntax	Comments
MO	MO for Mode
MM IN	MM – metric (millimeter) IN – imperial (inch)



**Example:**

G04 Defines aperture 10 as a circle with diameter 0.25mm\*

%MOMM\*%

...

%ADD10C, 0.25\*%

Metric is recommended. Imperial is there for historic reasons only and will be deprecated at a future date.

## 4.2.2 Format Specification (FS)

The coordinates and distances in operations - the X,Y,I and J – are integers, not decimals, to simplify and speed up processing. The coordinate unit is a decimal fraction of the file unit set by the MO command. The fraction is set by the FS (Format Specification) command. In other words, the FS command specifies where the decimal point must be set to convert an integer coordinate expressed in coordinate units to a decimal coordinate expressed in file units.

The FS command must be used *once and only once*, in the header, before the first operation command. The syntax is:

```
FS = '%' ('FS' 'LA' 'X' coord_digits 'Y' coord_digits) '*%';
coord_digits = /[1-6][56]/;
```

Syntax	Comments
FS	FS for Format Specification
LA	These fixed characters are necessary for backwards compatibility. (They pertain to deprecated format options, see 8.2.1.)
X coord_digits Y coord_digits	Specifies the number of integer and decimal file unit digits coordinate data. The values for X and Y coordinate <i>must</i> be the same. (The two values, in X and Y, are there purely for backwards compatibility.)
coord_digits	The first digit sets the maximum number of integer digits in the coordinate data. The number of integer digits can be 1 up to 6; use a number that is sufficient for the size of the image; 3 integer digits is typical.  The second digit sets the number of decimal digits. For example, if the MO command sets the file to metric, the base unit is mm, and the FS commands sets 6 decimal digits 6, then the coordinate unit is $10^{-6}$ mm, or nm. The number of decimal digits must be 5 or 6, with 6 recommended.



**Example:** The file unit is mm, the coordinate unit is  $10^{-6}$  mm, or nm.

```
%MOMM*%
```

```
%FSLAX36Y36*%
```

Coordinate Units		
	%MOMM*%	%MOIN*%
%FSLAX<n>3Y<n>3*%	1 $\mu$ m ( $10^{-3}$ mm)	1 mil ( $10^{-3}$ inch) = 25.4 $\mu$ m
%FSLAX<n>4Y<n>4*%	100 nm ( $10^{-4}$ mm)	0.1 mil ( $10^{-4}$ inch) = 2.54 $\mu$ m
%FSLAX<n>5Y<n>5*%	10 nm ( $10^{-5}$ mm)	0.01 mil ( $10^{-5}$ inch) = 254.0 nm
%FSLAX<n>6Y<n>6*%	1 nm ( $10^{-6}$ mm)	0.001 mil ( $10^{-6}$ inch) = 25.4 nm

Red is deprecated, green is current. <n> is a digit, e.g 3.

*Always use metric, with 6 decimals.*

It is sometimes argued that 6 decimals is overkill as the PCB design grid is much coarser. This is not a valid argument. Many points in a Gerber file are calculated; intersections, certainly with circles, have rational or even irrational coordinates, resulting in rounding errors. Even small perturbations can turn an otherwise perfect arc into an invalid one or turn an impeccable contour in an invalid self-intersecting one. The root cause for most errors such as missing clearances is the use of low resolution and they are solved when metric with 6 decimals is used instead. The only downside to high resolution is that the file becomes about 5% bigger, which is not a reason to throw away precision and risk scrap. There is no reason to use antiquated imperial units. An underlying component or design grid may be imperial, but a nm unit expresses any imperial value of 1/100 mil or larger without rounding error – amply sufficient for PCBs. By using inch, which is 25.4 times larger than mm, one gives up precision for no gain.

## 4.3 Aperture Definition (AD)

### 4.3.1 AD Command

The AD command creates an aperture, attaches the aperture attributes at that moment in the attribute dictionary to it and adds it to the apertures dictionary.

The syntax for the AD command is as follows:

```
AD = '%' ('AD' aperture_ident template_call) '**%';
template_call = template_name [',' parameter {'X' parameter}*];
```

Syntax	Comments
AD	'AD' is the command code
aperture_ident	The aperture identification being defined ( $\geq 10$ ). The aperture numbers can range from 10 up to 2.147.483.647 (max int 32). The D00 to D09 are reserved and cannot be used for apertures. Once an aperture number is assigned it cannot be re-assigned – thus apertures are uniquely identified by their number.
template_call	Set the shape of the aperture by calling a template with actual parameters
template_name	The name of the template, either a standard aperture or macro (see 2.2). It follows the syntax of names (see 3.4.5).
[',' parameter {'X' parameters}*];	The number and meaning of the actual parameters depend on the template. Parameters are decimals. All sizes are in the unit of the MO command.

The AD command must precede the first use of the aperture. It is recommended to put all AD commands in the file header.



#### Example:

```
%ADD10C, .025*%
%ADD10C, 0.5X0.25*%
```

Section 5.8 has examples to illustrate how to attach aperture attributes to an aperture.



### 4.3.2 Zero-size Apertures

Generally, apertures with size zero are invalid, and neither are objects created with them.

There is one exception. The C (circular) standard aperture with zero diameter is allowed, and so are objects created with it. Attributes can be attached to them. For the avoidance of doubt, it is only the C aperture where zero-size is valid, not another aperture type whose shape is fortuitously circular.

Zero-size objects do not affect the image. They can be used to provide meta-information to locations in the image plane.

Allowed does *not* mean recommended, quite in the contrary. If you are tempted to use a zero-size object, consider whether it is useful, and whether there is no proper way to convey the meta-information. Do not abuse a zero-size object to indicate the *absence* of an object, e.g. by flashing a zero-size aperture to indicate the absence of a flash. This is just confusing. If there is nothing, put nothing.

### 4.3.3 Examples

Syntax	Comments
<code>%ADD10C, .025*%</code>	Create aperture with number 10: a solid circle with diameter 0.025
<code>%ADD22R, .050X.050X.027*%</code>	Creates aperture 22: a rectangle with sides of 0.05 – therefore forming a square - and with a 0.027 diameter round hole
<code>%ADD57O, .030X.040X.015*%</code>	Creates aperture 57: an obround with sizes 0.03 x 0.04 with 0.015 diameter round hole
<code>%ADD30P, .016X6*%</code>	Creates aperture 30: a solid polygon with 0.016 outer diameter and 6 vertices
<code>%ADD15CIRC*%</code>	Creates aperture 15: instantiate the macro aperture template CIRC defined previously with an aperture macro (AM) command

## 4.4 Standard Aperture Templates

### 4.4.1 Overview

Standard Aperture Templates			
Name	Shape	Parameters	Ref.
C	Circle	Diameter[, Hole diameter]	4.4.2
R	Rectangle	X size, Y size[, Hole diameter]	4.4.3
O	Obround	X size, Y size[, Hole diameter]	4.4.4
P	Polygon	Outer diameter, # vertices[, Rotation[, Hole diameter]]	4.4.5

*Table with standard aperture templates*

### 4.4.2 Circle

The syntax of the circle standard template call is:

**template\_call = 'C' ', diameter 'X' hole\_diameter**

Syntax	Comments
C	Indicates the circle aperture template.
diameter	Diameter. A decimal $\geq 0$ .
hole_diameter	Diameter of a round hole. A decimal $> 0$ . If omitted the aperture is solid. See also section 4.4.6.



#### Examples:

```
%ADD10C,0.5*%
```

```
%ADD10C,0.5X0.25*%
```

These commands define the following apertures:

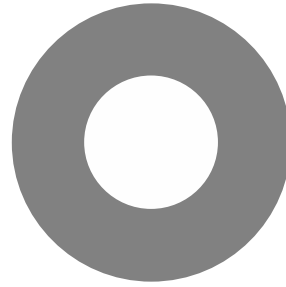
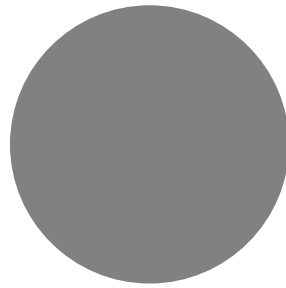

*5. Circles*

## 4.4.3 Rectangle

The syntax of the rectangle or square standard template call is:

**template\_call = 'R' ', x\_size 'X' y\_size 'X' hole\_diameter**

Syntax	Comments
R	Indicates the rectangle aperture template.
x_size y_size	X and Y sizes of the rectangle. Decimals >0. If x_size = y_size the effective shape is a square.
hole_diameter	Diameter of a round hole. A decimal >0. If omitted the aperture is solid. See also section 4.4.6.



### Examples:

```
%ADD22R,0.044X0.025*%
```

```
%ADD23R,0.044X0.025X0.019*%
```

These commands define the following apertures:

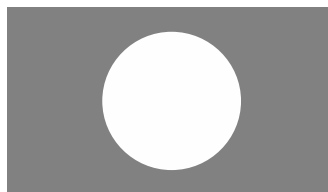

## 6. Rectangles

## 4.4.4 Obround

Obround (oval) is a shape consisting of two semicircles connected by parallel lines tangent to their endpoints. It can be viewed as a rectangle where the smallest side is rounded to a half-circle. The syntax of the obround template call is:

**template\_call = 'O' ', x\_size 'X' y\_size 'X' hole\_diameter**

Syntax	Comments
O	Indicates the obround aperture template.
x_size y_size	X and Y sizes of enclosing box. Decimals >0. If x_size = y_size the effective shape is a circle.
hole_diameter	Diameter of a round hole. A decimal >0. If omitted the aperture is solid. See also section 4.4.6.



### Example:

```
%ADD220,0.046X0.026*%
```

```
%ADD220,0.046X0.026X0.019*%
```

These commands define the following apertures:

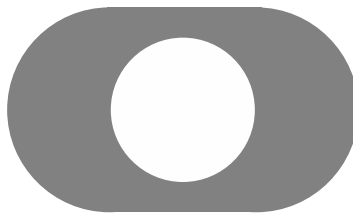
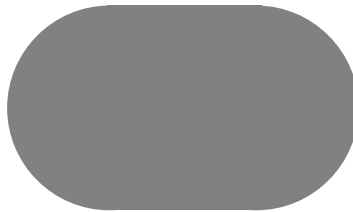

*7. Obrounds*

## 4.4.5 Polygon

Creates a *regular* polygon aperture. The syntax of the polygon template is:

**template\_call = 'P' ', outer\_diameter 'X' vertices 'X' rotation 'X' hole\_diameter**

Syntax	Comments
P	Indicates the polygon aperture template.
outer_diameter	Diameter of the circle circumscribing the regular polygon, i.e. the circle through the polygon vertices. A decimal > 0.
vertices	Number of vertices n, $3 \leq n \leq 12$ . An integer.
rotation	The rotation angle, in degrees counterclockwise. A decimal. With rotation angle zero there is a vertex on the positive X-axis through the aperture center.
hole_diameter	Diameter of a round hole. A decimal > 0. If omitted the aperture is solid. See also section 4.4.6.



### Examples:

```
%ADD17P, .040X6*%
```

```
%ADD17P, .040X6X0.0X0.019*%
```

These commands define the following apertures:

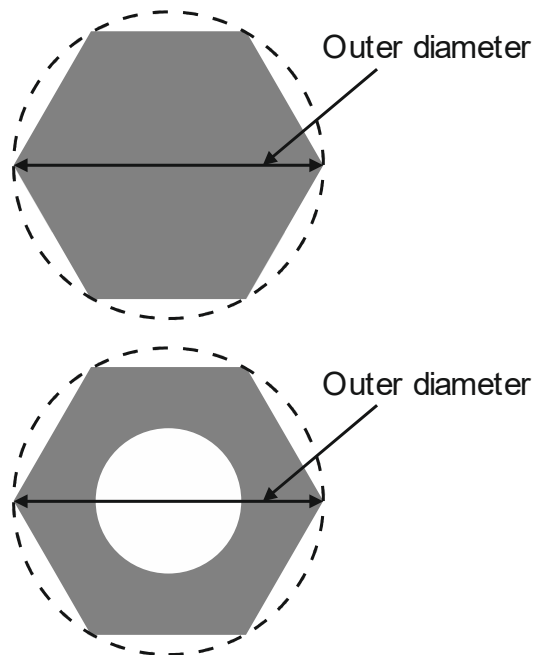

## 8. Polygons

## 4.4.6 Transparency of Holes

Standard apertures may have a round hole in them. When an aperture is flashed only the solid part affects the image, the hole does *not*. Objects under a hole remain visible through the hole. For image generation the area of the hole behaves exactly as the area outside the aperture. The hole is not part of the aperture.

 **Warning:** Make no mistake: holes do *not* clear the objects under them.

For all standard apertures the round hole is defined by specifying its diameter as the last parameter: <Hole diameter>. If <Hole diameter> is omitted the aperture is solid. If present the diameter must be > 0. The hole must strictly fit within the standard aperture. It is centered on the aperture.

### Example:

```
%FSLAX26Y26*%  
%MOMM*%  
%ADD10C,10X5*%  
%ADD11C,1*%  
G01*  
%LPD*%  
D11*  
X-25000000Y-1000000D02*  
X25000000Y1000000D01*  
D10*  
X0Y0D03*  
M02*
```



### 9. Standard (circle) aperture with a hole above a draw

Note that the draw is visible through the hole.

## 4.5 Aperture Macro (AM)

The AM command creates a macro aperture template and adds it to the aperture template dictionary (see 2.2). A template is a parametrized shape. The AD command instantiates a template into an aperture by supplying values to the template parameters.

Templates of any shape or parametrization can be created. Multiple simple shapes called primitives can be combined in a single template. An aperture macro can contain variables whose actual values are defined by:

- Values provided by the AD command
- Arithmetic expressions with other variables

The template is created by positioning primitives in a coordinate space. The origin of that coordinate space will be the origin of all apertures created with the state.

A template must be defined before the first AD that refers to it. The AM command can be used multiple times in a file.

Attributes are *not* attached to templates. They are attached to the aperture at the time of its creation with the AD command.

An AM command contains the following words:

- The AM declaration with the macro name
- Primitives with their comma-separated parameters
- Macro variables, defined by an arithmetic expression

The syntax for the AM command is:

```

AM = '%' ('AM' macro_name macro_body) '%';
macro_name = name '*';
macro_body = {in_macro_block}+;
in_macro_block =
    |primitive
    |variable_definition
    ;
variable_definition = (macro_variable '=' expression) '*';
macro_variable = '$' positive_integer;
primitive = primitive_code {' , ' par}*
par = ';' (expression);
    
```

Syntax	Comments
AM	AM for Aperture Macro
<Macro name>	Name of the aperture macro. The name must be unique, it cannot be reused for another macro. See 3.4.5 for the syntax rules.
<Macro body>	The macro body contains the primitives generating the image and the calculation of their parameters.
<Variable definition>	\$n=<Arithmetic expression>. An arithmetic expression may use arithmetic operators (described later), constants and variables \$m defined previously.



Syntax	Comments
<Primitive>	A primitive is a basic shape to create the macro. It includes primitive code identifying the primitive and primitive-specific parameters (e.g. center of a circle). See 4.5.1. The primitives are positioned in a coordinates system whose origin is the origin of the resulting apertures.
<Primitive code>	A code specifying the primitive (e.g. polygon).
<Parameter>	Parameter can be a decimal number (e.g. 0.050), a variable (e.g. \$1) or an arithmetic expression based on numbers and variables. The actual value is calculated as explained in 4.5.4.3.

Coordinates and sizes are expressed in the unit set by the MO command.

A parameter can be either:

- A decimal number
- A macro variable
- An arithmetic expression

A macro variable name must be a '\$' character followed by an integer >0, for example \$12. (This is a subset of names allowed in 3.4.3.)



**Note:** New lines can be added between words of a single command to enhance readability. They do not affect the macro definition.



**Example:**

The following AM command defines an aperture macro named 'Triangle\_30'.

```
%AMTriangle_30*
4,1,3,
1,-1,
1,1,
2,1,
1,-1,
30*
%
```

## 4.5.1 Primitives

### 4.5.1.1 Overview

Macro Primitives			
Code	Name	Parameters	Ref.
0	Comment	A comment string	4.5.1.2
1	Circle	Exposure, Diameter, Center X, Center Y[, Rotation]	4.5.1.3
20	Vector Line	Exposure, Width, Start X, Start Y, End X, End Y, Rotation	4.5.1.4
21	Center Line	Exposure, Width, Hight, Center X, Center Y, Rotation	4.5.1.5
4	Outline	Exposure, # vertices, Start X, Start Y, Subsequent points..., Rotation	4.5.1.6
5	Polygon	Exposure, # vertices, Center X, Center Y, Diameter, Rotation	4.5.1.7
7	Thermal	Center X, Center Y, Outer diameter, Inner diameter, Gap, Rotation	4.5.1.8

*Table with macro primitives*

Except for the comment all the parameters can be a decimal, integer, macro variables or an arithmetic expression.

## 4.5.1.2 Comment, Code 0

The comment primitive has no effect on the image but adds human-readable comments in an AM command. The comment primitive starts with the '0' code followed by a space and then a single-line text string. The text string follows the syntax for strings in section 3.4.3.



### Example:

```
%AMBox*
0 Rectangle with rounded corners, with rotation*
0 The origin of the aperture is its center*
0 $1 X-size*
0 $2 Y-size*
0 $3 Rounding radius*
0 $4 Rotation angle, in degrees counterclockwise*
0 Add two overlapping rectangle primitives as box body*
21,1,$1,$2-$3-$3,0,0,$4*
21,1,$1-$3-$3,$2,0,0,$4*
0 Add four circle primitives for the rounded corners*
$5=$1/2*
$6=$2/2*
$7=2x$3*
1,1,$7,$5-$3,$6-$3,$4*
1,1,$7,-$5+$3,$6-$3,$4*
1,1,$7,-$5+$3,-$6+$3,$4*
1,1,$7,$5-$3,-$6+$3,$4*%
```

### 4.5.1.3 Circle, Code 1

A circle primitive is defined by its center point and diameter.

Parameter number	Description
1	Exposure off/on (0/1)
2	Diameter $\geq 0$
3	Center X coordinate.
4	Center Y coordinate.
5	Rotation angle of the center, in degrees counterclockwise. The primitive is rotated around the origin of the macro definition, i.e. the (0, 0) point of macro coordinates. The rotation parameter is optional. The default is no rotation.

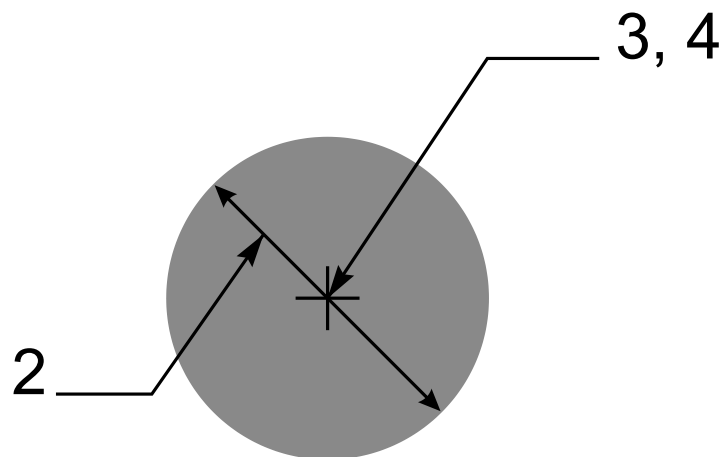

10. Circle primitive

Below there is the example of the AM command that uses the circle primitive.



**Example:**

```
%AMCircle*
1,1,1.5,0,0,0*%
```

### 4.5.1.4 Vector Line, Code 20.

A vector line is a rectangle defined by its line width, start and end points. The line ends are rectangular.

Parameter number	Description
1	Exposure off/on. (0/1)
2	Width of the line $\geq 0$ .
3	Start point X coordinate.
4	Start point Y coordinate.
5	End point X coordinate.
6	End point Y coordinate.
7	Rotation angle, in degrees counterclockwise. The primitive is rotated around the origin of the macro definition, i.e. the (0, 0) point of macro coordinates

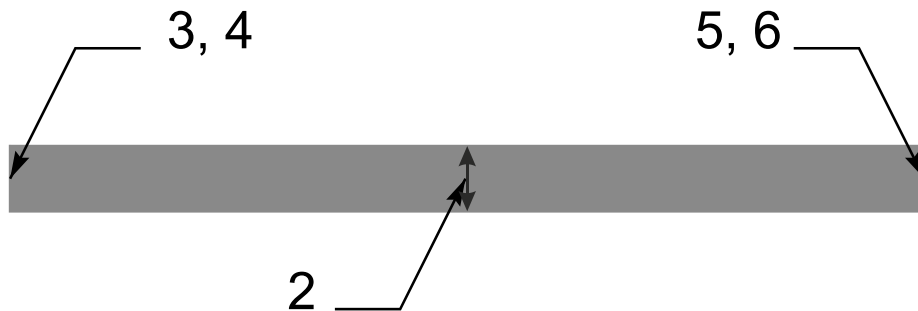

### 11. Vector line primitive

Below there is the example of the AM command that uses the vector line primitive.



**Example:**

```
%AMLine*
20,1,0.9,0,0.45,12,0.45,0*
%
```

## 4.5.1.5 Center Line, Code 21

A center line primitive is a rectangle defined by its width, height, and center point.

Parameter number	Description
1	Exposure off/on. (0/1)
2	Width $\geq 0$ .
3	Height $\geq 0$ .
4	Center point X coordinate.
5	Center point Y coordinate.
6	Rotation angle, in degrees counterclockwise. The primitive is rotated around the origin of the macro definition, i.e. (0, 0) point of macro coordinates. <b>⚠ Warning:</b> The rotation is <i>not</i> around the center point. (Unless the center point happens to be the macro origin.)

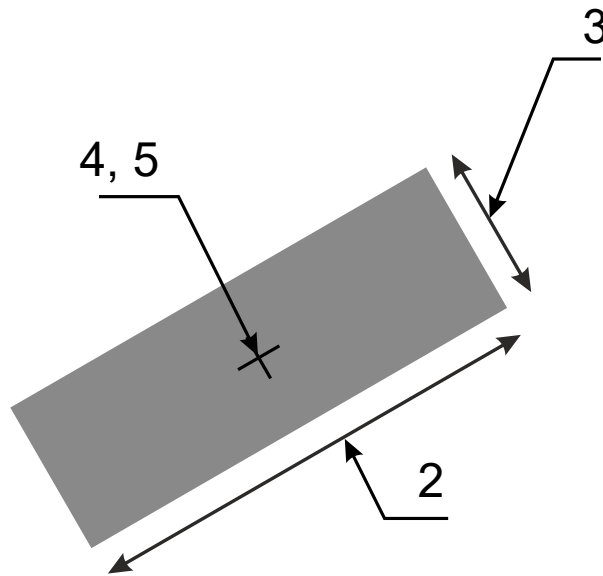

12. Center line primitive

Below there is the example of the AM command that uses the center line primitive.



**Example:**

```
%AMRECTANGLE*
21, 1, 6.8, 1.2, 3.4, 0.6, 30*%
```

### 4.5.1.6 Outline, Code 4

An outline primitive is an area defined by its outline or contour. The outline is a polygon, consisting of linear segments only, defined by its start vertex and n subsequent vertices. The outline must be closed, i.e. the last vertex must be equal to the start vertex. The outline must comply with all the requirements of a contour according to 4.10.3.

Parameter number	Description
1	Exposure off/on (0/1)
2	The number of vertices of the outline = the number of coordinate pairs <i>minus one</i> . An integer $\geq 3$ .
3, 4	Start point X and Y coordinates.
5, 6	First subsequent X and Y coordinates.
...	Further subsequent X and Y coordinates. The X and Y coordinates are <i>not</i> modal: both X <i>and</i> Y must be specified for all points.
3+2n, 4+2n	Last subsequent X and Y coordinates. As the outline must be closed the last coordinates <i>must</i> be equal to the start coordinates.
5+2n	Rotation angle, in degrees counterclockwise, a decimal. The primitive is rotated around the origin of the macro definition, i.e. the (0, 0) point of macro coordinates.

### 13. Outline primitive

The maximum number of vertices is 5000. The purpose of this primitive is to create apertures to

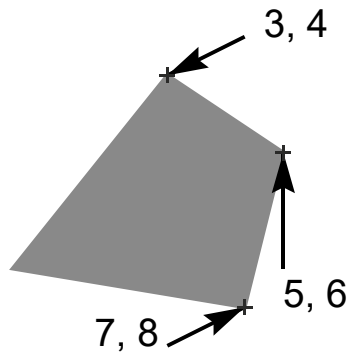

flash *pads* with special shapes. The purpose is not to create copper pours. Use the region statement for copper pours; see 4.10.

 **Example:**

The following AM command defines an aperture macro named 'Triangle\_30'. The macro is a triangle rotated 30 degrees around the origin of the macro definition:

```
%AMTriangle_30*
4,1,3,
1,-1,
1,1,
2,1,
1,-1,
30*
%
```

Syntax	Comments
AM Triangle_30	Aperture macro name is 'Triangle_30'
4,1,3	4 – Outline 1 – Exposure on 3 – The outline has three subsequent points
1,-1	1 – X coordinate of the start point -1 – Y coordinate of the start point
1,1, 2,1, 1,-1,	Coordinates (X, Y) of the subsequent points: (1,1), (2,1), (1,-1). Note that the last point is the same as the start point
30	Rotation angle is 30 degrees counterclockwise

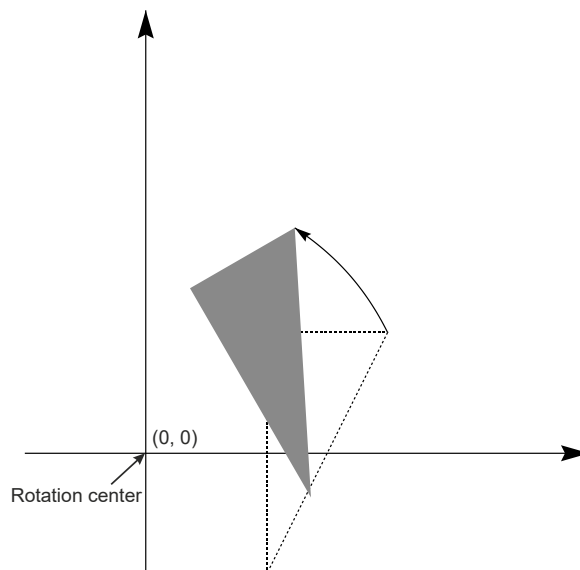

**14. Rotated triangle**



## 4.5.1.7 Polygon, Code 5

A polygon primitive is a regular polygon defined by the number of vertices  $n$ , the center point and the diameter of the circumscribed circle.

Parameter number	Description
1	Exposure off/on (0/1)
2	Number of vertices $n$ , $3 \leq n \leq 12$ . An integer. The first vertex is on the positive X-axis through the center point when the rotation angle is zero.
3	Center point X coordinate. A
4	Center point Y coordinate.
5	Diameter of the circumscribed circle $\geq 0$ .
6	Rotation angle, in degrees counterclockwise. With rotation angle zero there is a vertex on the positive X-axis through the aperture center. The primitive is rotated around the origin of the macro definition, i.e. the (0, 0) point of macro coordinates.

15. Polygon primitive

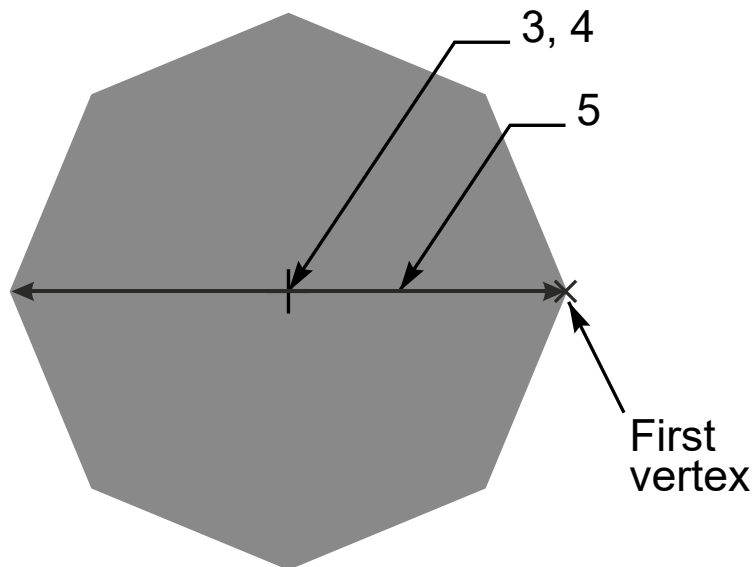

**Example:**

```
%AMPolygon*
5,1,8,0,0,8,0*%
```

## 4.5.1.8 Thermal, Code 7

The thermal primitive is a ring (annulus) interrupted by four gaps. Exposure is always on.

Parameter number	Description
1	Center point X coordinate.
2	Center point Y coordinate.
3	Outer diameter > inner diameter
4	Inner diameter $\geq 0$
5	Gap thickness < (outer diameter)/ $\sqrt{2}$ . Note that if the (gap thickness)* $\sqrt{2} \geq$ (inner diameter) the inner circle disappears. This is not invalid. The gaps are on the X and Y axes through the center without rotation. They rotate with the primitive.
6	Rotation angle, in degrees counterclockwise. A decimal. The primitive is rotated around the origin of the macro definition, i.e. (0, 0) point of macro coordinates.

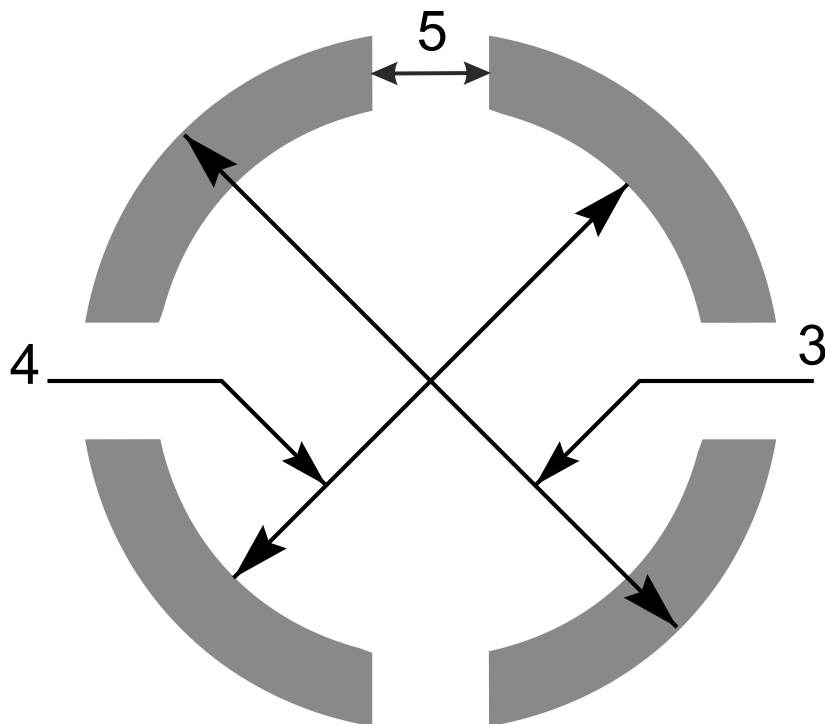

16. Thermal primitive

## 4.5.2 Exposure Parameter

The exposure parameter that can take two values:

- 0 means exposure is 'off'
- 1 means exposure is 'on'

Primitives with exposure 'on' create the solid part of the macro aperture. Primitives with exposure 'off' erase the solid part created earlier *in the same macro*. Exposure off is used to create a hole in the aperture – see also 4.4.6.

The erasing action of exposure off only acts on other primitives within the same macro definition. When a macro is flashed the hole does not clear objects in the final image – the hole is transparent. Another way of expressing it is that the macro definition is flattened before it is used, and the result is a positive image.



**Warning:** When the macro aperture is flashed, the erased area does *not* clear the underlying graphical objects. Objects under removed parts remain visible.



### Example:

```
%FSLAX26Y26*%
%MOMM*%
%AMSquareWithHole*
21,1,10,10,0,0,0*
1,0,5,0,0*%
%ADD10SquareWithHole*%
%ADD11C,1*%
G01*
%LPD*%
D11*
X-25000000Y-2000000D02*
X25000000Y1000000D01*
D10*
X0Y0D03*
M02*
```



17. Macro aperture with a hole above a draw

Note that the draw is still visible through the hole.

### 4.5.3 Rotation Parameter

All primitives can be rotated around the *origin* of the macro definition, i.e. its point (0, 0). (Make no mistake: rotation is *not* around the geometric center of the primitive, unless of course it coincides with the origin.)

A rotation angle is expressed by a decimal number, in degrees counterclockwise. A positive angle means counterclockwise rotation, a negative angle clockwise. The rotation angle is defined by the rotation parameter, the last in the list of the primitive parameters.

To rotate a macro composed of several primitives it is sufficient to rotate all primitives by the same angle. See illustration below.

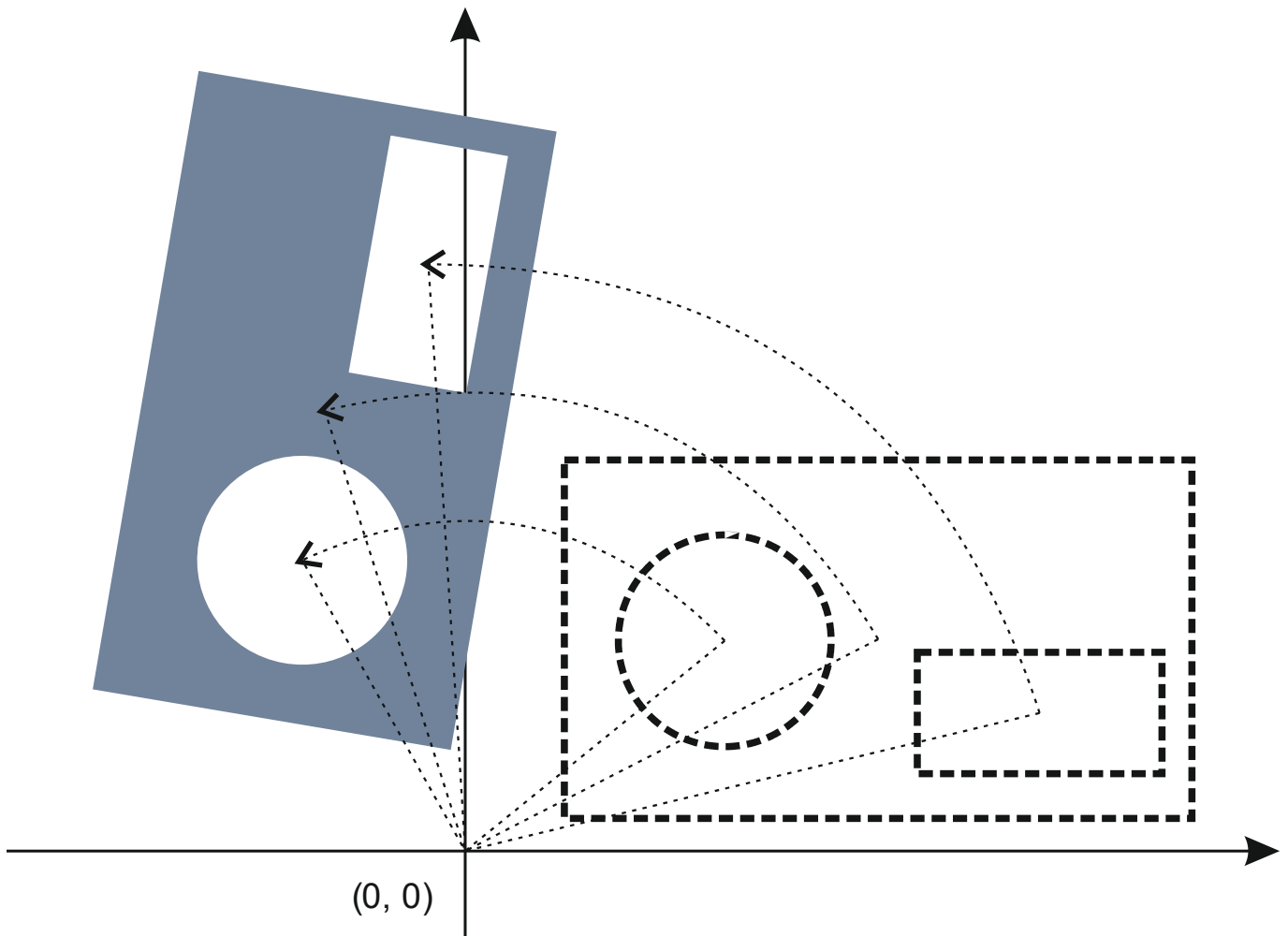

18. Rotation of an aperture macro composed of several primitives

**Warning:** Rotation is around the origin of the macro definition, not around the geometric center of the primitive – unless the two coincide of course. The reason is obvious: if rotation were about the center of each primitive a composite aperture like the one above would fall apart under rotation.

## 4.5.4 Macro Variables and Expressions

### 4.5.4.1 Variable Values from the AD Command

An AM command can use variables whose actual values are provided by the AD command calling the macro. Such variables are identified by '\$n' where n indicates the index in the list of the variable values provided by the AD command. Thus \$1 means the first value in the list, \$2 the second, and so on.



#### Example:

```
%AMDONUTVAR*1,1,$1,$2,$3*1,0,$4,$2,$3*%
```

\$1, \$2, \$3 and \$4 are macro variables. With the following calling AD

```
%ADD34DONUTVAR,0.100X0X0X0.080*%
```

the variables take the following values:

\$1 = 0.100

\$2 = 0

\$3 = 0

\$4 = 0.080

### 4.5.4.2 Arithmetic Expressions

A parameter value can also be defined by an arithmetic expression consisting of integer and decimal constants, other variables, arithmetic operators and the brackets '(' and ')'. The standard arithmetic precedence rules apply. The following arithmetic operators are available:

Operator	Function
+	Unary plus (expressions without the unary sign are positive)
-	Unary minus
+	Add
-	Subtract
x (lower case)	Multiply
/	Divide. The result is a decimal; it is not rounded or truncated to an integer.

*Arithmetic operators*



#### Example:

```
%AMRect*
```

```
21,1,$1,$2-2*$3,-$4,-$5+$2,0*%
```

The corresponding AD command could be:

```
%ADD146Rect,0.0807087X0.1023622X0.0118110X0.5000000X0.3000000*%
```

### 4.5.4.3 Definition of a New Variable

New variables can be defined by an assign statement as follows: \$4=\$1x1.25-\$3. The right-hand side is any arithmetic expression as in the previous section.



### Example:

```
%AMDONUTCAL*
1, 1, $1, $2, $3*
$4=$1x1.25*
1, 0, $4, $2, $3*%
```

The variable values are determined as follows:

- \$1, \$2, . . . , \$n take the values of the n parameters of the calling AD command.
- New variables get their value by evaluating their defining expression.
- Undefined variables are 0.

Macro variables *cannot* be redefined.



### Example:

```
%AMDONUTCAL*
1, 1, $1, $2, $3*
$5=$1x0.75*
1, 0, $5, $2, $3*%
%ADD35DONUTCAL, 0.020X0X0X0.03*%
```

The AD command contains 4 parameters. The first four macro variables take the values: \$1 = 0.02, \$2 = 0, \$3 = 0, \$4 = 0.03. \$5 is defined later and becomes \$5 = 0.02 x 0.75 = 0.015.

Below are some more examples to illustrate the syntax to define macro variables.



### Examples:

```
%AMTEST1*
1, 1, $1, $2, $3*
$4=$1x0.75*
$5=($2+100)x1.75*
1, 0, $4, $5, $3*%
```

```
%AMTEST2*
$4=$1x0.75*
$5=100+$3*
1, 1, $1, $2, $3*
1, 0, $4, $2, $5*
$6=$4x0.5*
1, 0, $6, $2, $5*%
```

## 4.5.5 Examples

### 4.5.5.1 Fixed Parameter Values

The following AM command defines an aperture macro named 'DONUTFIX' consisting of two concentric circles with fixed diameter sizes:

```
%AMDONUTFIX*
1, 1, 0.100, 0, 0*
1, 0, 0.080, 0, 0*%
```

Syntax	Comments
AMDONUTFIX	Aperture macro name is 'DONUTFIX'
1,1,0.100,0,0	1 – Circle 1 – Exposure on 0.100 – Diameter 0 – X coordinate of the center 0 – Y coordinate of the center
1,0,0.080,0,0	1 – Circle 0 – Exposure off 0.080 – Diameter 0 – X coordinate of the center 0 – Y coordinate of the center

An example of an AD command using this aperture macro:

```
%ADD33DONUTFIX*%
```

#### 4.5.5.2 Variable Parameter Values

The following AM command defines an aperture macro named 'DONUTVAR' consisting of two concentric circles with variable diameter sizes:

```
%AMDONUTVAR*  
1, 1, $1, $2, $3*  
1, 0, $4, $2, $3*%
```

Syntax	Comments
AMDONUTVAR	Aperture macro name is 'DONUTVAR'
1,1,\$1,\$2,\$3	1 – Circle 1 – Exposure on \$1 – Diameter is provided by AD command \$2 – X coordinate of the center is provided by AD command \$3 – Y coordinate of the center is provided by AD command
1,0,\$4,\$2,\$3	1 – Circle 0 – Exposure off \$4 – Diameter is provided by AD command \$2 – X coordinate of the center is provided by AD command (same as in first circle) \$3 – Y coordinate of the center is provided by AD command (same as in first circle)

The AD command using this aperture macro can look like the following:

```
%ADD34DONUTVAR, 0.100X0X0X0.080*%
```

In this case the variable parameters get the following values: \$1 = 0.100, \$2 = 0, \$3 = 0, \$4 = 0.080.

### 4.5.5.3 Definition of a New Variable

The following AM command defines an aperture macro named 'DONUTCAL' consisting of two concentric circles with the diameter of the second circle defined as a function of the diameter of the first:

```
%AMDONUTCAL*
1,1,$1,$2,$3*
$4=$1x0.75*
1,0,$4,$2,$3*%
```

Syntax	Comments
AMDONUTCAL	Aperture macro name is 'DONUTCAL'
1,1,\$1,\$2,\$3	1 – Circle 1 – Exposure on \$1 – Diameter is provided by AD command \$2 – X coordinate of the center is provided by AD command \$3 – Y coordinate of the center is provided by AD command
\$4=\$1x0.75	Defines variable \$4 to be used as the diameter of the inner circle; the diameter of this circle is 0.75 times the diameter of the outer circle
1,0,\$4,\$2,\$3	1 – Circle 0 – Exposure off \$4 – Diameter is calculated with the previous definition of this variable \$2 – X coordinate of the center is provided by AD command (same as in first circle) \$3 – Y coordinate of the center is provided by AD command (same as in first circle)

The AD command using this aperture macro can look like the following:

```
%ADD35DONUTCAL,0.020X0X0*%
```

This defines a donut with outer circle diameter equal to 0.02 and inner circle diameter equal to 0.015.



## 4.5.5.4 A useful macro

The following example creates a rectangle with rounded corners, useful as SMD pad.

It uses the following construction:

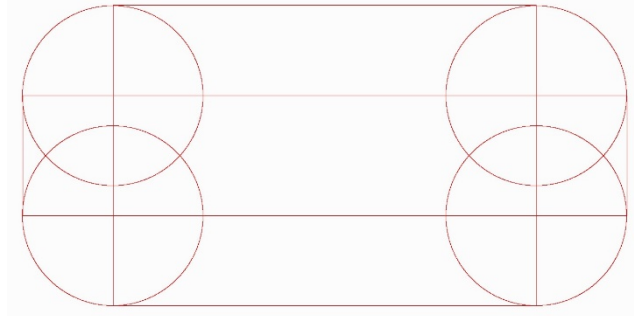

19. Construction of the Box macro

```
%AMBox*
0 Rectangle with rounded corners, with rotation*
0 The origin of the aperture is its center*
0 $1 X-size*
0 $2 Y-size*
0 $3 Rounding radius*
0 $4 Rotation angle, in degrees counterclockwise*
0 Add two overlapping rectangle primitives as box body*
21,1,$1,$2-$3-$3,0,0,$4*
21,1,$2-$3-$3,$2,0,0,$4*
0 Add four circle primitives for the rounded corners*
$5=$1/2*
$6=$2/2*
$7=2x$3*
1,1,$7,$5-$3,$6-$3,$4*
1,1,$7,-$5+$3,$6-$3,$4*
1,1,$7,-$5+$3,-$6+$3,$4*
1,1,$7,$5-$3,-$6+$3,$4*%
```

## 4.6 Set Current Aperture (Dnn)

The command Dnn ( $nn \geq 10$ ) sets the current aperture graphics state parameter. The syntax is:

**Dnn = 'D unsigned\_integer \*\*';**

Syntax	Comments
D	Command code
<aperture number>	The aperture number (integer $\geq 10$ ). An aperture with that number must be in the apertures dictionary.

D-commands 0 to 9 are reserved and *cannot* be used for apertures. The D01 and D03 commands use the current aperture to create track and flash graphical objects.



### Example:

D10\*

## 4.7 Interpolation State Commands (G01,G02,G03,G75)

### 4.7.1 Linear Interpolation (G01)

G01 sets linear interpolation mode. In linear interpolation mode a D01 operation generates a linear segment, from the current point to the (X, Y) coordinates in the command. The current point is then set to the (X, Y) coordinates.

The segment is stroked with the current aperture to create a *draw graphical object*, except in a region statement where the segment is added to the contour under construction.

The G01 command sets linear operation. The syntax is as follows:

**G01 = ('G01') '\*';**

Syntax	Comments
G01	Sets interpolation mode graphics state parameter to 'linear interpolation'

**D01 = ([ 'X' x\_coordinate] [ 'Y' y\_coordinate] 'D01') '\*';**

Syntax	Comments
x_coordinate	An integer specifying the X coordinate of the end point of the straight segment. The default is the X coordinate of the current point.
y_coordinate	As above, but for the Y axis.
D01	Interpolate operation code

The coordinates are interpreted as specified by the FS and MO command.



#### Example:

```
G01*
X250000Y155000D01*
```

#### 4.7.2 Circular Interpolation (G02, G03, G75)

G02 sets clockwise circular interpolation mode, G03 counterclockwise. In circular interpolation mode a D01 operation generates an arc segment, from the current point to the (X, Y) coordinates in the command. The current point is then set to the (X, Y) coordinates.

The segment is stroked with the current aperture to create an *arc graphical object*, except in a region statement where the segment is added to the contour under construction.

For compatibility with older versions of the Gerber format, a G75\* must be issued before the first D01 in circular mode.

The syntax of these commands is:

**G02 = ('G02') '\*';**

**G03 = ('G03') '\*';**

**G75 = ('G75') '\*';**

Syntax	Comments
G02	Sets interpolation mode graphics state parameter to 'clockwise circular interpolation'
G03	Sets interpolation mode graphics state parameter to 'counterclockwise circular interpolation'
G75	This command must be issued before the first circular interpolation operation, for compatibility with older Gerber versions



#### Examples:

G02\*

G75\*

The syntax of the D01 command in circular interpolation mode is:

**D01 = (['X' x\_coordinate] ['Y' y\_coordinate] ['I' x\_offset] ['J' y\_offset] 'D01') '\*';**

Syntax	Comments
x_coordinate	x_coordinate
y_coordinate	As above, but for the Y axis.
i_offset	Add the I offset to the X coordinate of the start point of the arc to calculate the X of the center of the arcs. <Offset> is an integer.
j_offset	As above, but for the Y axis.
D01	Interpolate operation code

The coordinates and offsets are interpreted according as specified by the FS and MO command.

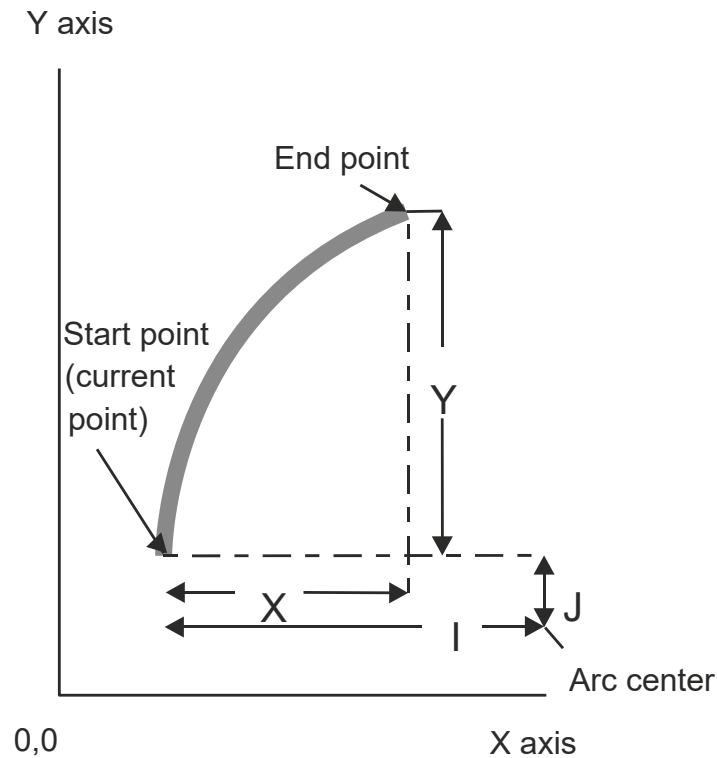

## 20. Circular interpolation example



### Example:

```
G75*
G03*
X75000Y50000I40000J0D01*
```

When start point and end point coincide the result is a full 360° arc. An example:

Syntax	Comments
D10*	Select aperture 10 as current aperture
G01*	Set linear interpolation mode
X0Y600D02*	Set the current point to (0, 6)
G75*	Must be called before an arc is created.
G02*	Set clockwise circular interpolation mode
X0Y600I500J0D01*	Create arc object to (0, 6) with center (5,6)

The resulting image is a full circle.

Note that arcs where the start point and end point of an arc very close together are unstable: a small change in their relative position can turn a large arc in a small one and vice versa, dramatically changing the image. A typical case is very small arcs: start and end point are close together; if due to rounding the end point is slightly moved to coincide with the start point the small arc becomes a full arc.

Rounding must be done carefully. Using high resolution is an obvious prerequisite. See 4.14. The Gerber writer must also consider that the reader unavoidably has rounding errors. Perfectly exact numerical calculation cannot be assumed. It is the responsibility of the writer to avoid unstable arcs. Arcs shorter than say 2µm must be replaced with a draw - draws are intrinsically

stable and the error is negligible. Near full arcs must be cut in two big arcs, which too are intrinsically stable.

 **Warning:** A Gerber file that attempts to create an arc without a preceding G75 is invalid.

### 4.7.2.1 Example

Syntax	Comments
X3000000Y-2000000D02*	Set the current point to (3, -2) mm
G75*	Must be called before an arc is created
G03*	Set counterclockwise interpolation mode
X-3000000Y-2000000I-3000000J4000000D01*	Create arc object counterclockwise to (-3,-2). The offsets from the start point to the center point are 3 for X and 4 for Y, i.e. the center point is (0, 2)

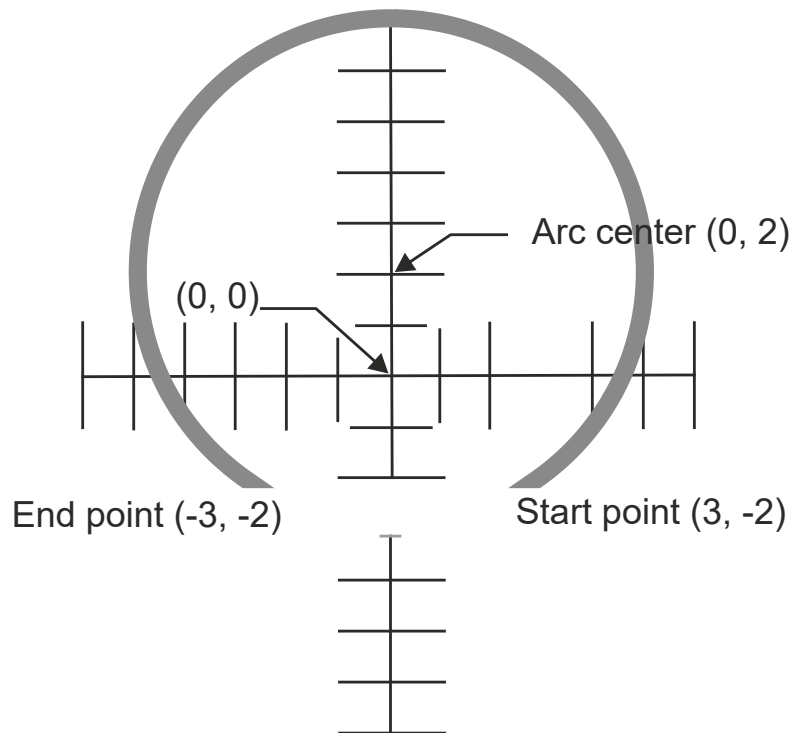

21. Arc example

### 4.7.2.2 Valid Arcs

Mathematically, the distance from the center to the start point must be exactly equal to the distance to the end point. However, a Gerber file has a finite resolution. It is therefore generally not possible to position the center point exactly so that both distances – radii - are indeed exactly equal. Furthermore, the software generating the Gerber file unavoidably adds rounding errors of its own. In real files the center is unavoidably not positioned exactly, and the two radii are not equal. We will call the difference between the start and end radius the *arc deviation*.

A mathematically exact circle has of course zero deviation. The interpretation of the arc command is then obvious. However, which curve is represented by a “circular arc” with a non-

zero deviation? It cannot be a circular arc with the given center. Either it is not circular, it has another center, or it does not go from start to end. The curve is defined as follow.

*Any continuous and monotonic curve starting at the start point and ending at the end point, approximating the ring with the given center point and with inner and outer radii equal to the start radius and end radius is a valid rendering of the arc command. See figure below.*

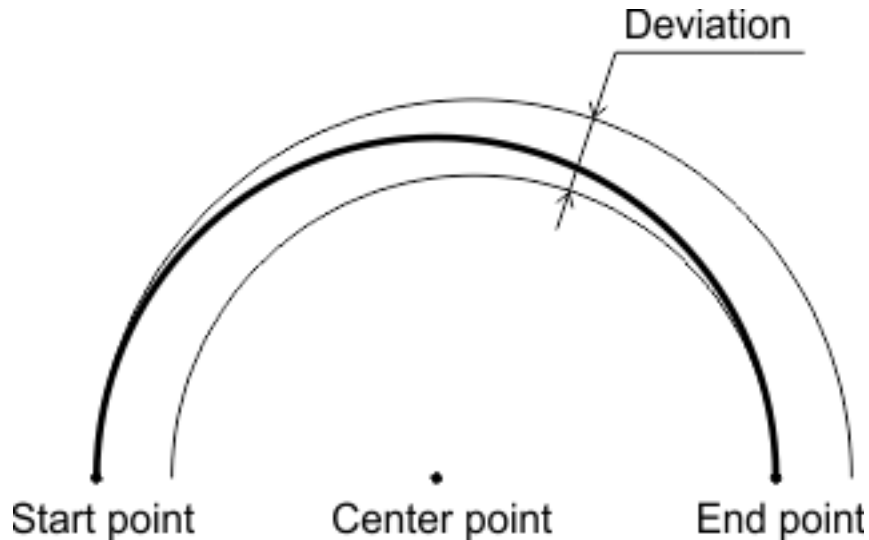

22. Arc with a non-zero deviation

The arc therefore has a fuzziness of the order of magnitude of the arc deviation. The writer of the Gerber file accepts any interpretation within the fuzziness above as valid. If the writer requires a more precise interpretation of the arc he needs to write more precise arcs, with lower deviation.

It is however not allowed to place the center point close to the straight line through begin and end point except when it is strictly in between these points. When the center is on or outside the segment between start and end point the construct is nonsensical. See figure below.

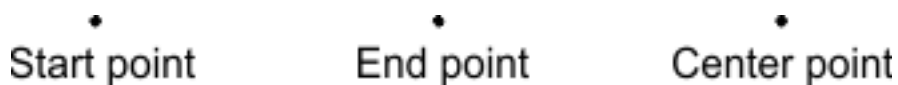

23. Nonsensical center point

Note that self-intersecting contours are not allowed, see 4.10.3. If any of the valid arc interpretations turns the contour in a self-intersecting one, the file is invalid, with unpredictable results.

The root cause of most problems with arcs is the use a low resolution. One sometimes attempts to force arcs of size of the order of e.g. 1/10 of a mil in a file with resolution of 1/10. This is asking for problems. Use higher resolution. See 4.14.

## 4.8 Operations (D01/D02/D03)

### 4.8.1 Overview

Commands consisting of coordinate data followed by a D01, D02 or D03 function code are called *operations*.

- Operation with D01 code is called *interpolate* operation. It creates a straight-line segment or a circular segment by interpolating from the current point to the operation coordinates. The segment is then stroked with the current aperture to generate a draw or arc graphical object, except in a region statement where the segment is added to the contour being constructed. The current point is moved to operations coordinate before processing the next command.
- Operation with D02 code is called *move* operation. It moves the current point to the operation coordinates. No graphical object is generated.
- Operation with D03 code is called *flash* operation. It creates a flash object by replicating (flashing) the current aperture at the operation coordinates. When the aperture is flashed its origin is positioned at the coordinates of the operation. The origin of a standard aperture is its geometric center. The origin of a macro aperture is the origin used in the defining AM command. The current point is moved to operations coordinate before processing the next command.

The operations are controlled by the graphics state (see 2.5), as summarized in the table below. G01 sets linear, G02 clockwise and G03 counterclockwise circular interpolation.

Operation code	Inside a region statement (G36/G37)		Outside a region statement	
	Linear mode (G01)	Circular mode (G02, G03)	Linear mode (G01)	Circular mode (G02, G03)
D01	Adds linear segment to the contour under construction  Moves current point	Adds circular segment to the contour under construction  Moves current point	Creates a draw  Moves current point	Creates an arc  Moves current point
D02	Starts a new contour  Moves current point		Moves current point	
D03	Not allowed		Creates a flash  Moves current point	

*Effect of operation codes depending on graphics state*



The parameters of the operations are coordinate data, see 4.2. The FS and MO commands specify how to interpret the coordinate data.



## Examples:

X200Y200D02*	move to (+200, +200)
Y-300D03*	flash at (+200, -300)
I300J100D01*	interpolate to (+200, -300) with center offset (+300, +100)
Y200I50J50D01*	interpolate to (+200, +200) with center offset (+50, +50)
X200Y200I50J50D01*	interpolate to (+200, +200) with center offset (+50, +50)
X+100I-50D01*	interpolate to (+100, +200) with center offset (-50, 0)
D03*	flash at (+100,+200)

#### 4.8.2 Interpolate (D01)

Performs an interpolation operation, creating a draw or an arc segment. The interpolation state defines which type of segment is created, see 4.7. The syntax depends on the required parameters, and, hence, on the interpolation state.

Interpolation state	Syntax
Linear (G01)	<b>D01 = ('X' x_coordinate] ['Y' y_coordinate] 'D01') '**';</b>
Circular (G02 G03)	<b>D01 = ('X' x_coordinate] ['Y' y_coordinate] 'I' x_offset 'J' y_offset ) 'D01' '**';</b>

Syntax	Comments
x_coordinate	<Coordinate> is coordinate data – see section 0. It defines the X coordinate of the new current point. The default is the X coordinate of the old current point.
y_coordinate	As above, but for the Y coordinate
i_offset	<Offset> is the offset in X – see section 0. It defines the X coordinate the center of the circle. It is of the coordinate type. There is no default offset.
j_offset	As above, but for the Y axis.
D01	Move operation code

After the interpolation operation the current point is set to X,Y.

#### 4.8.3 Move (D02)

Moves the current point to the (X,Y) in the comment. The syntax is:

**D02 = ('X' x\_coordinate] ['Y' y\_coordinate] 'D02') '\*\*';**

Syntax	Comments
x_coordinate	<Coordinate> is coordinate data – see section 0. It defines the X coordinate of the new current point. The default is the X coordinate of the old current point.
y_coordinate	As above, but for the Y coordinate.
D02	Move operation code

The D02 command sets the new value for the current point. Inside a region statement it also closes the current contour and starts a new one. (see 4.10).



#### Example:

X2152000Y1215000D02\*

#### 4.8.4 Flash (D03)

Performs a flash operation, creating a flash object at (X,Y). The syntax is:

**D03 = ('X' x\_coordinate] ['Y' y\_coordinate] 'D03') '\*\*';**

Syntax	Comments
x_coordinate	<Coordinate> is an integer specifying the X coordinate of the aperture origin. The default is the X coordinate of the old current point.
y_coordinate	As above, but for the Y coordinate.
D03	Flash operation code



**Example:**

```
X1215000Y2152000D03*
```

After the flash operation the current point is set to (X,Y).

### 4.8.5 Example

The example shows a stream of commands in a Gerber file. Some of the commands are operation codes, others are G code commands (G01, G03, G36, G37, G74, and G75). The G code commands set the graphics state parameters that are relevant for the operations: interpolation mode (G01, G02, G03, G75) – see 4.7.



**Example:**

```
X275000Y115000D02*
G01*
X2512000Y115000D01*
G75*
G03*
X5005000Y3506000I3000J0D01*
G01*
X15752000D01*
Y12221000D01*
```

## 4.9 Aperture Transformations (LP, LM, LR, LS)

### 4.9.1 Overview

The commands LP, LM, LR and LS load the following object transformation graphics state parameters:

Object transformation commands		
Command	Long name	Parameter
LP	Load polarity	Polarity (Positive, Negative)
LM	Load mirroring	Mirror axis (N X Y XY)
LR	Load rotation	Rotation angle
LS	Load scaling	Scaling factor

An object transformation parameter transforms the current aperture when it is used to create object. The transformation is temporary, after the object is created the current aperture returns to its original value. Consequently, the parameter is always applied on the original shape of the current aperture.

The polarity option directly sets the polarity of the objects. The mirror/rotate/scale parameters affect the shape of the objects by *temporarily* transforming the current aperture before the object is created. The apertures are mirrored/rotated/scaled around the flash point according to the transformation parameters and then used as such in flashes, draws and arcs. As the current aperture does not affect regions, the mirror/rotate/scale parameters do not affect the region either.

Object transformation parameters become effective immediately after loading and remain in effect until a new value is loaded. No other command alters the object transformation parameters. The object transformation parameters affect neither the aperture dictionary nor the current aperture.



#### Example on how the parameter changes affect the image

D123*	Select D123
X5000Y7000D03*	Flash D123
%LR90.0*%	Set object rotation to 90 degrees
X6000Y8000D03*	Flash D123 rotated 90 degrees
D124*	Select D124
X6000Y8000D03*	Flash D124 rotated 90 degrees
%LR0.0*%	Set object rotation to 0 degrees
X7000Y9000D03*	Flash D124, not rotated
D123*	Select D123
X1000Y2000D03*	Flash D123, this is the original, not rotated

## Example of the effect on interpolations (draws and arcs)

%MOMM\*%

%FSLAX26Y26\*%

%ADD10C,1\*%

Define aperture 10 as a 1mm circle

D10\*

Select aperture 10

G01\*

Set linear interpolation

X000000000Y000000000D02\*

Move to origin

X010000000D01\*

Draw a 1mm thick line

%LS1.5\*%

Set scale factor to 1.5

Y020000000D01\*

Draw a 1.5mm thick line

M02\*

This results in the following image:

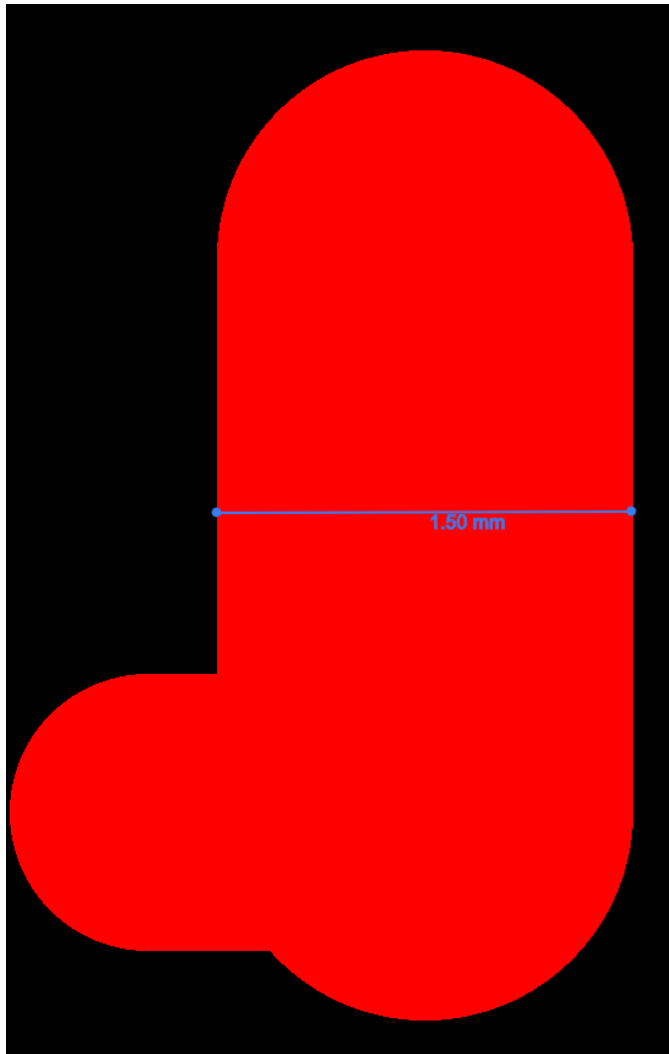

## 4.9.2 Load Polarity (LP)

The LP command sets the *polarity graphics state parameter*, see 2.5. It defines the polarity applied to objects when they are created. Polarity can be either *dark* or *clear*. Its effect is explained in 2.7. There is an example in 4.10.4.6. The syntax for the LP command is:

**LP = '%' ('LP' ('C'|'D')) '\*%';**

Syntax	Comments
LP	LP for Load Polarity
C D	C – clear polarity D – dark polarity

The LP command can be used multiple times in a file. The polarity remains as set until overruled by another LP command.



**Example. Set clear object polarity.**

`%LPC*%`

## 4.9.3 Load Mirroring (LM)

The LM command sets the *mirroring graphics state parameter*, see 2.5. The mirroring option defines the mirroring axis used when creating objects. The aperture is mirrored around its *origin* (which may not be its geometric center) before being used. The syntax for the LM command is:

**LM = '%' ('LM' ('N'|'XY'|'Y'|'X')) '\*%';**

Syntax	Comments
LM	LM for Load Mirroring
N X Y XY	N – No mirroring X – Mirroring <i>along</i> the X axis; mirror left to right; the signs of the x coordinates are inverted Y – Mirroring <i>along</i> the Y axis; mirror top to bottom; the signs of the y coordinates are inverted XY – Mirroring <i>along</i> both axes; mirror left to right and top to bottom; the signs of both the x <i>and</i> y coordinates are inverted



Mirroring is performed *before* the rotation.

The LM command can be used multiple times in a file. The mirroring remains as set until overruled by another LM command. Mirroring is set at the value in the command, it is *not* cumulated with the previous value.



**Example. Set no object mirroring.**

`%LMN*%`

The LM command was introduced in revision 2016.12.

## 4.9.4 Load Rotation (LR)

The LR command sets the *rotation graphics state parameter*, see 2.5. It defines the rotation angle used when creating objects. The aperture is rotated around its *origin* (which may or may not be its geometric center). The syntax for the LR command is:

**LR = '%' ('LR' decimal) '\*\*%';**

Syntax	Comments
LR	LR for Load Rotation
<Rotation>	The rotation angle, in degrees, counterclockwise. A decimal.

 Mirroring is performed *before* the rotation.

The LR command can be used multiple times in a file. The object rotation remains as set until overruled by a subsequent LR command. Rotation is set at the value in the command, it is *not* cumulated with the previous value.

 **Example. Set object rotation to 90°.**

```
%LR90*%
```

The LR command was introduced in revision 2016.12.

### 4.9.5 Load Scaling (LS)

The LS command sets the *scaling graphics state parameter*, see 2.5. It defines the scale factor used when creating objects. The aperture is scaled centered on its *origin* (which may or may not be its geometric center). The syntax for the LS command is:

**LS = '%' ('LS' decimal) '\*\*%';**

Syntax	Comments
LS	LS for Load Scaling
<Scale>	A decimal > 0.

The LS command can be used multiple times in a file. The object scaling remains as set until overruled by a subsequent LS command. Scaling is set at the value in the command, it is *not* cumulated with the previous scale factor.

 **Example. Set object scaling to 80%.**

```
%LS0.8*%
```

The LS command was introduced in revision 2016.12.

### 4.9.6 Example

A block flashed in different mirroring, orientation, scaling

```
G04 Ucamco copyright*
%TF.GenerationSoftware,Ucamco,UcamX,2016.04-160425*%
%TF.CreationDate,2016-04-25T00:00:00+01:00*%
%FSLAX26Y26*%
%MOMM*%
%ADD10C,1*%
%LPD*%
G04 Define block aperture D12*
%ABD12*%
%ADD11C,0.5*%
D10*
G01*
```

```
X-2500000Y-1000000D03*  
Y1000000D03*  
%LPC*%  
D11*  
X-2500000Y-1000000D03*  
%LPD*%  
X-500000Y-1000000D02*  
X2500000D01*  
G75*  
G03*  
X500000Y1000000I-2000000J0D01*  
G01*  
%AB*%  
G04 Flash block aperture D12 in four different orientation*  
D12*  
X0Y0D03*  
%LMX*%  
X1000000D03*  
%LMY*%  
%LR30.0*%  
X0Y800000D03*  
%LMXY*%  
%LR45.0*%  
%LS0.8*%  
X1000000D03*  
%LPD*%  
%LMN*%  
%LR0.0*%  
%LS1.0*%  
M02*
```

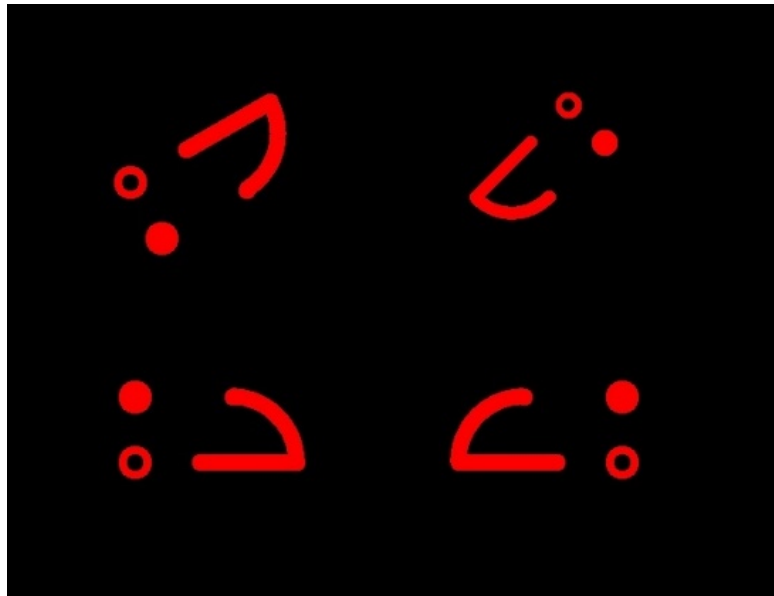

24. A block flashed in different orientations



## 4.10 Region Statement (G36/G37)

### 4.10.1 Region Overview

A region is a graphical object defined by its contour(s) - see 4.10.3.

The G36 command begins a region statement and G37 ends it. A region statement creates contour objects by defining its contour. In a region statement the D01 and D02 commands create the contour segments. The first D01 encountered in a region statement starts the first contour by creating the first segment. Subsequent D01's add segments to it. When a D02 command is encountered the contour is considered finished. (Note that a D02 without effect on the current point, e.g. a D02\*, also finishes the current contour. ) A D02 is only allowed if the preceding contour is closed. The next D01 command starts a new contour. Thus an unlimited number of contours can be created between a single G36/G37 commands pair.

When a G37 command is encountered, the region statement is closed and region graphical objects are added to the object stream by filling the newly created contours. All object *and aperture* objects are attached to the region. A G37 is only allowed when all contours are properly closed. A G37 finishes the last contour in the absence of a finishing D02. Each contour is filled individually. The overall filled area is the union of the filled areas of each individual contour. The number of region objects created by a single G36/G37 pair is intentionally *not* specified to leave more freedom to implementations; - for example, two overlapping contours may be merged in a single region object.

Holes in a region are defined with cut-ins (see 4.10.3 and 4.10.4.7).

D01 and D02 are the *only* D code commands allowed in a region statement; D03 and Dnn (nn≥10) are *not* allowed. Extended commands are *not* allowed. The M02 (end-of-file) command is *not* allowed. However, G code commands *are* allowed – they are needed to control the interpolation state.

Contour segments are not in themselves graphical objects –they define the regions which are graphical objects.

*Aperture* attributes can be attached to a region, see 5.3.1.

## 4.10.2 Region Statement Syntax

The G36 and G37 commands begin and end a region statement respectively. The syntax is:

**G36 = ('G36') '\*';**

**G37 = ('G37') '\*';**

Syntax	Comments
G36	Begins a region statement.
G37	Ends a region statement. This creates the set of region graphical object.

**interpolation\_state\_command =**

**|G01**

**|G02**

**|G03**

**|G75**

**;**

**region\_statement = G36 {contour}+ G37;**

**contour = D02 {D01|interpolation\_state\_command}\*;**

A valid contour must not only comply with this syntax, but the sequence of draws/arcs must represent a connected closed contour that does not self-intersect. See 4.10.3.

## 4.10.3 Valid Contours

A contour is a sequence of connected linear or circular segments. A pair of segments is said to connect only if they are defined consecutively, with the second segment starting where the first one ends. Thus, the order in which the segments are defined is significant. Non-consecutive segments that meet or intersect fortuitously are not considered to connect. A contour is closed: the end point of the last segment must coincide with the start point of the first segment. A contour thus defines a closed curve.

There are two classes of valid contours.

*Simple contours.* A contour is said to be *simple* if all its segments are disjoint, except for consecutive segments having only their connection point in common. However, zero-length segments have no effect: readers can remove them before processing the contour. (Avoid zero-length segments as they are useless and can only cause confusion.) A simple contour does not self-intersect or self-touch. The inside of the contour constitutes the region object. A simple contour defines a simple region, without holes.

*Simple cut-in contours.* These contours allow to create a region with holes. A cut-in connects the contour defining the hole to its enclosing contour, thus joining them into a single contour. If one travels along the contour in the direction of the segments and the inside must always be to the same side, just as for simple contours. See the illustration below; see 4.10.4.7 for a fully worked out example.

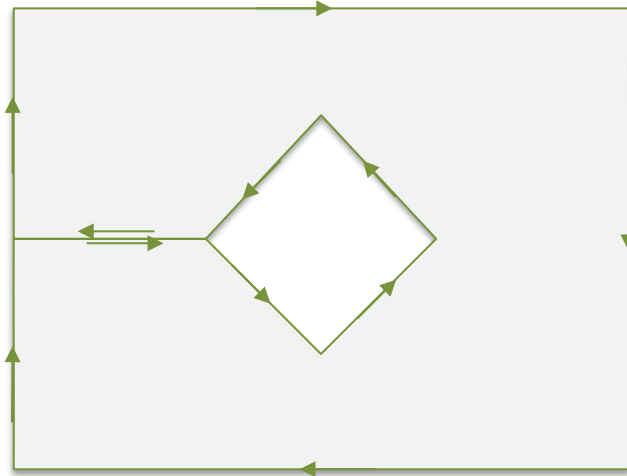

25. A contour with a cut-in

A cut-in is subject to strict requirements: it must consist of two *fully coincident* linear segments; a pair of linear segments are said to be fully coincident if the segments coincide completely, with the second segment starting where the first one ends; cut-ins must be either horizontal or vertical; all cut-ins in a contour must have the same direction; cut-ins cannot intersect the contour in any other location than their start and end points.

All contours except simple contours and simple cut-in contours are called *self-intersecting* and are *not allowed*. Segments *cannot* cross, overlap or touch except

- ❑ connected segments
- ❑ cut-ins.

Any other form of self-touching or self-intersection is *not allowed*. For the avoidance of doubt, not allowed are, amongst others: segments that partially overlap, fully coincident linear segments that are diagonal, fully coincident circular segments, circular segments that are tangent to another segment, vertices on a segment at another location than its endpoints, points where more than two segments end, full arcs except when the contour consist solely of that full arc or the full arc is at the end of a cut-in.

An invalid contour has no specified interpretation.

For the mathematically inclined: A contour is said to be *weakly simple* if there exists an arbitrarily small perturbation of the vertices changing it in a simple contour. Simple contours with cut-ins are weakly simple. The winding number for valid Gerber contours is for the outside 0 and for the inside everywhere either +1 or -1, depending on the orientation. However, not all weakly simple contours or contours with these winding numbers are valid.

Contours are also used to define outline primitives in macro apertures (see 4.5.1.6).

Processing Gerber files is inevitably subject to rounding errors. Contours must be constructed robustly so that perturbations due to this rounding do not turn an otherwise valid contour in a self-intersecting one. See 4.14.2.

In Gerber, the orientation of the contour is not significant.

 **Warning:** Use maximum resolution. Low file coordinate resolution brings uncontrolled rounding and often results in self-intersecting contours, see 4.1.

 **Warning:** Sloppy construction of cut-ins can lead to self-intersecting contours – in fact this is the most prevalent cause of missed clearances in planes. Construct cut-ins carefully or avoid them altogether by making holes in regions with negative objects.

## 4.10.4 Examples

### 4.10.4.1 A Simple Contour

Syntax	Comments
G36*	Begins a region statement
X200Y300000D02*	Set the current point to (2, 3). Begin of a contour.
G01*	Set linear interpolation mode
X700000D01*	Create linear segment to (7, 3)
Y100000D01*	Create linear segment to (7, 1)
X1100000Y500000D01*	Create linear segment to (11, 5)
X700000Y900000D01*	Create linear segment to (7, 9)
Y700000D01*	Create linear segment to (7, 7)
X200000D01*	Create linear segment to (2, 7)
Y300000D01*	Create linear segment to (2, 3), closing the contour.
G37*	Create the region by filling the contour.

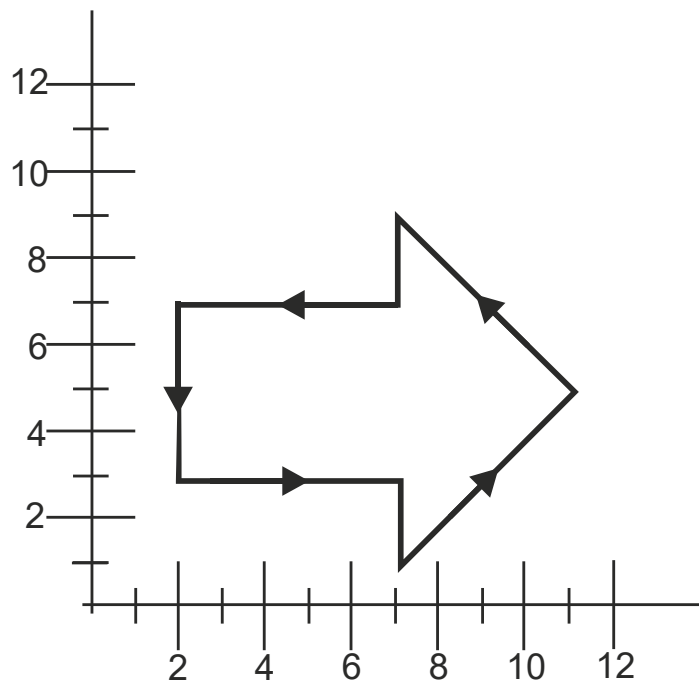

26. Simple contour example: the segments

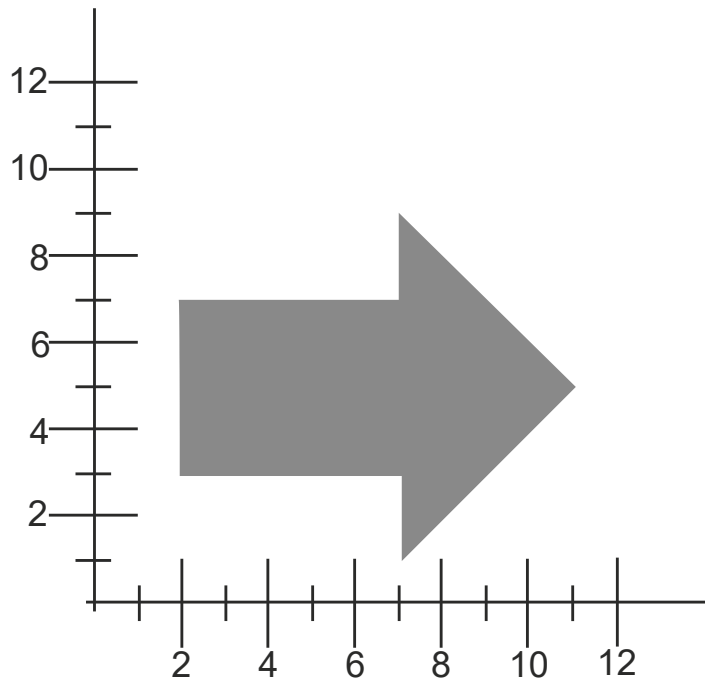

27. Simple contour example: resulting image

#### 4.10.4.2 Use D02 to Start a Second Contour

D02 command can be used to start the new contour. All the created contours are converted to regions when the command G37 is encountered. The example below creates two non-overlapping contours which are then converted into two regions.



#### Example:

```
G04 Non-overlapping contours*
%FSLAX24Y24*%
%MOMM*%
%ADD10C,1.00000*%
G01*
%LPD*%
G36*
X0Y50000D02*
Y100000D01*
X100000D01*
Y0D01*
X0D01*
Y50000D01*
X-10000D02*
X-50000Y10000D01*
X-90000Y50000D01*
X-50000Y90000D01*
X-10000Y50000D01*
G37*
M02*
```

This creates the following image:

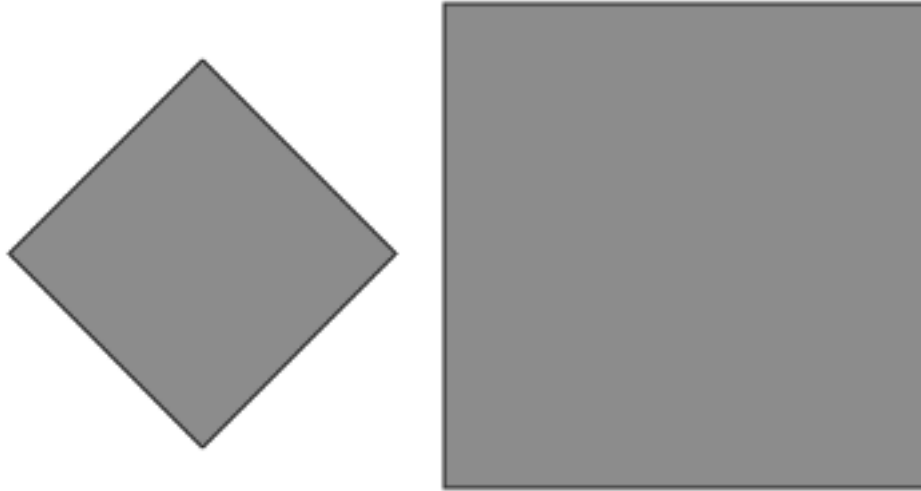

28. Use of D02 to start a new non-overlapping contour

Two different contours were created. Each contour is filled individually. The filled area is the union of the filled areas.

#### 4.10.4.3 Overlapping Contours

The example below creates two overlapping contours which are then converted into one region.



##### Example:

```
G04 Overlapping contours*
%FSLAX24Y24*%
%MOMM*%
%ADD10C,1.00000*%
G01*
%LPD*%
G36*
X0Y50000D02*
Y100000D01*
X100000D01*
Y0D01*
X0D01*
Y50000D01*
X10000D02*
X50000Y10000D01*
X90000Y50000D01*
X50000Y90000D01*
X10000Y50000D01*
G37*
M02*
```

This creates the following image:

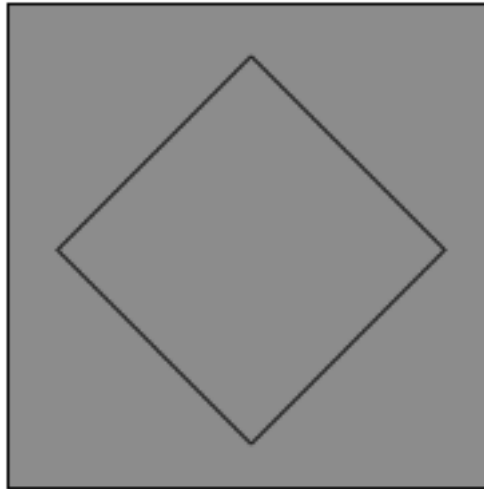

29. Use of D02 to start a new overlapping contour

Two different contours were created. Each contour is filled individually. The filled area is the union of the filled areas. As the second contour is completely embedded in the first, the effective filled area is the one of the first contour. The created region object is the same as would be defined by the first contour only.

#### 4.10.4.4 Non-overlapping and Touching

The example below creates two non-overlapping touching contours which are then converted into one region.



##### Example:

```
G04 Non-overlapping and touching*
%FSLAX24Y24*%
%MOMM*%
%ADD10C,1.00000*%
G01*
%LPD*%
G36*
X0Y50000D02*
Y100000D01*
X100000D01*
Y0D01*
X0D01*
Y50000D01*
D02*
X-50000Y10000D01*
X-90000Y50000D01*
X-50000Y90000D01*
X0Y50000D01*
G37*
M02*
```

This creates the following image:

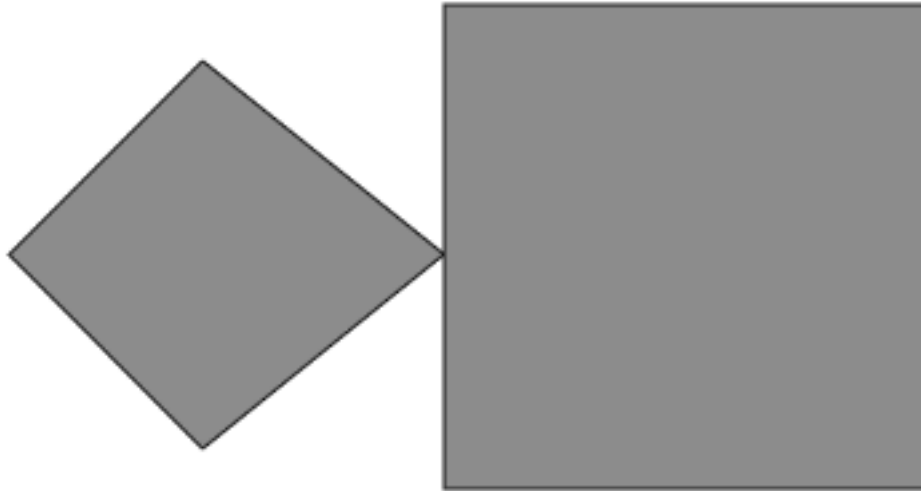

### 30. Use of D02 to start a new non-overlapping contour

As these are two different contours in the same region touching is allowed.

#### 4.10.4.5 Overlapping and Touching

The example below creates two overlapping touching contours which are then converted into one region.



#### Example:

```
G04 Overlapping and touching*
%FSLAX24Y24*%
%MOMM*%
%ADD10C,1.00000*%
G01*
%LPD*%
G36*
X0Y50000D02*
Y100000D01*
X100000D01*
Y0D01*
X0D01*
Y50000D01*
D02*
X50000Y10000D01*
X90000Y50000D01*
X50000Y90000D01*
X0Y50000D01*
G37*
M02*
```

This creates the following image:



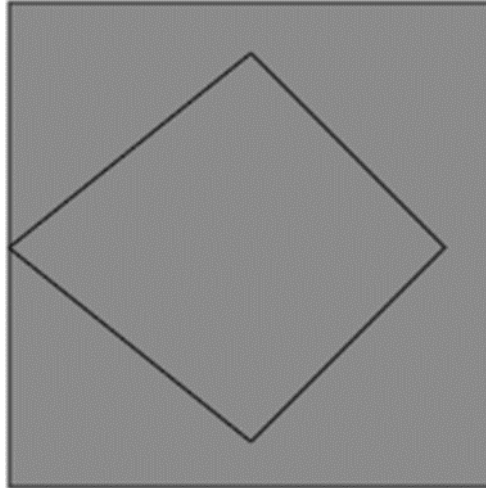

31. Use of D02 to start a new overlapping and touching contour

As these are two different contours in the same region touching is allowed.

#### 4.10.4.6 Using Polarity to Create Holes

The recommended way to create holes in regions is by alternating dark and clear polarity, as illustrated in the following example. Initially the polarity mode is dark. A big square region is generated. The polarity mode is set to clear and a circular disk is added to the object stream; the disk is cleared from the image and creates a round hole in the big square. Then the polarity is set to dark again and a small square is added to the stream, darkening the image inside the hole. The polarity is set to clear again and a small disk added, clearing parts of the big and the small squares.



#### Example:

```
G04 This file illustrates how to use polarity to create holes*
%FSLAX25Y25*%
%MOMM*%
G01*
G04 First object: big square - dark polarity*
%LPD*%
G36*
X2500000Y2500000D02*
X17500000D01*
Y17500000D01*
X2500000D01*
Y2500000D01*
G37*
G04 Second object: big circle - clear polarity*
%LPC*%
G36*
G75*
X5000000Y10000000D02*
G03*
X5000000Y10000000I5000000J0D01*
G37*
```

G04 Third object: small square - dark polarity\*

%LPD\*%

G01\*

G36\*

X7500000Y7500000D02\*

X12500000D01\*

Y12500000D01\*

X7500000D01\*

Y7500000D01\*

G37\*

G04 Fourth object: small circle - clear polarity\*

%LPC\*%

G36\*

G75\*

X11500000Y10000000D02\*

G03\*

X11500000Y10000000I2500000J0D01\*

G37\*

M02\*

Below there are pictures which show the resulting image after adding each object.



*32. Resulting image: first object only*

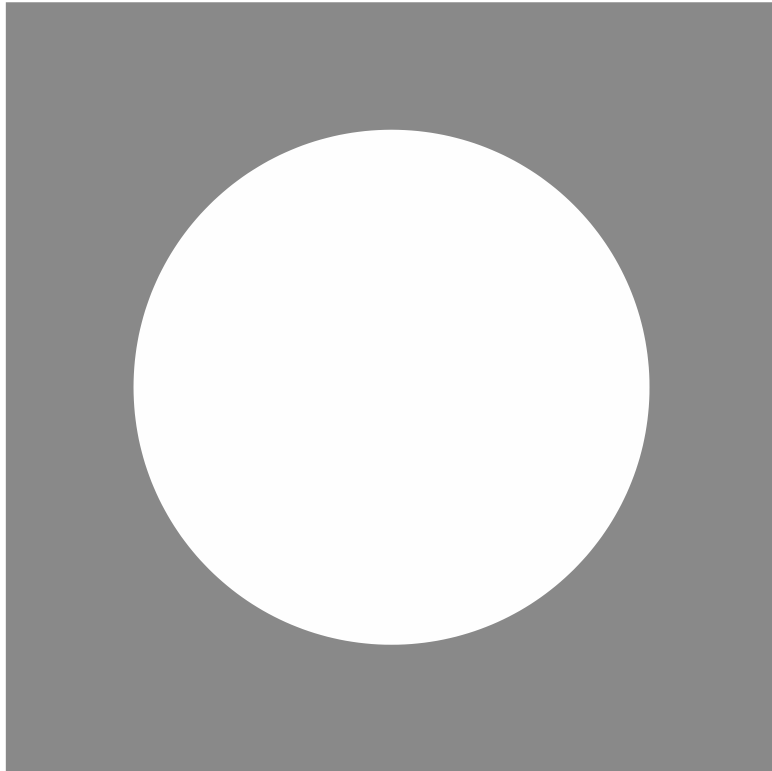

*33. Resulting image: first and second objects*



*34. Resulting image: first, second and third objects*



*35. Resulting image: all four objects*

#### **4.10.4.7 A Simple Cut-in**

The example below illustrates how a simple cut-in can be used to create a hole in a region. The coinciding contour segments must follow the requirements defined in 4.10.3.

Syntax	Comments
%FSLAX26Y26*%	Format specification
G75*	Must be called before an arc is created
G36*	Begins a region statement
X20000Y10000000D02*	Set the current point to (2,10)
G01*	Set linear interpolation mode
X12000000D01*	Create linear contour segment to (12,10)
Y20000000D01*	Create linear contour segment to (12, 2)
X2000000D01*	Create linear contour segment to (2, 2)
Y6000000D01*	Create linear contour segment to (2, 6)
X5000000D01*	Create linear contour segment to (2, 6)
G03*	Create linear contour segment to (2, 6)
X50000Y60000I30000J0D01*	Create linear contour segment to (5, 6), 1 <sup>st</sup> fully coincident segment
G01*	Set counterclockwise circular interpolation mode
X20000D01*	Create counterclockwise circle with radius 3
Y100000D01*	Set linear interpolation mode
G37*	Create linear contour segment to (2, 6), 2 <sup>nd</sup> fully coincident segment
	Create linear contour segment to (2, 10)
	Create the region by filling the contour

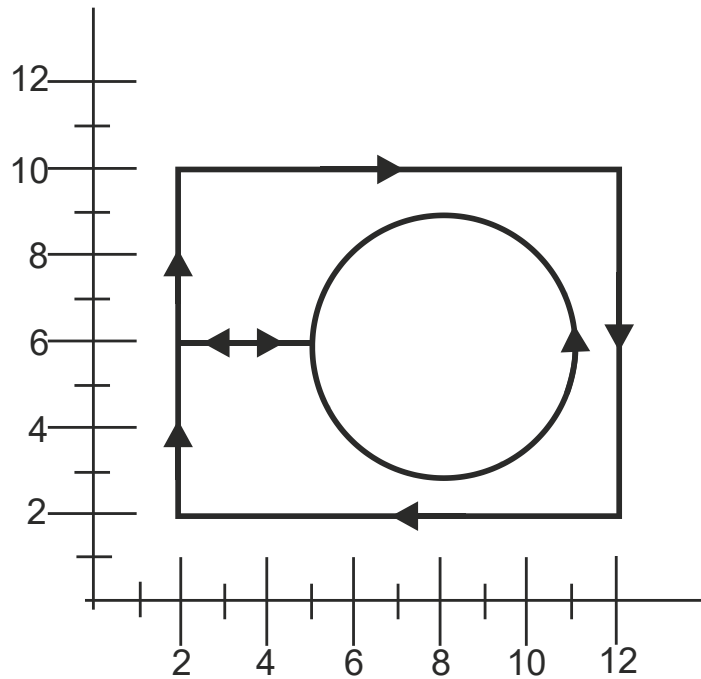

*36. Simple cut-in: the segments*

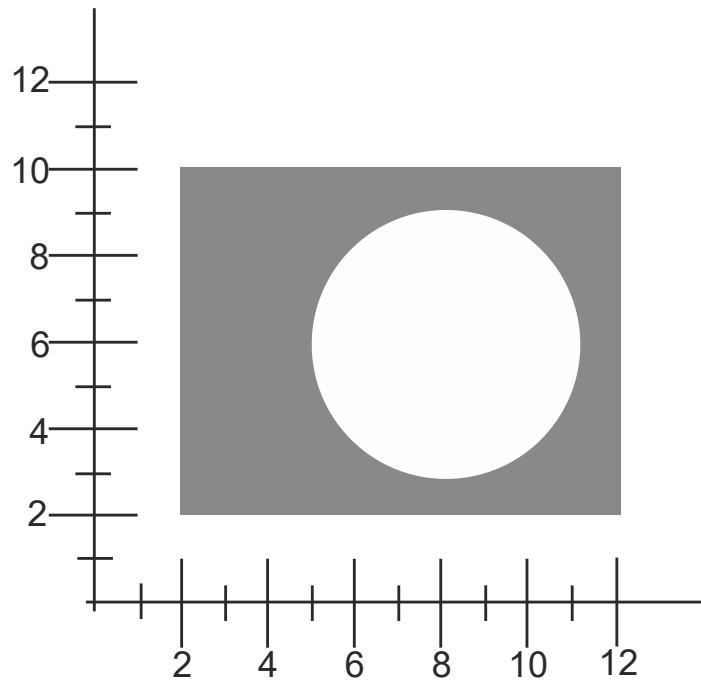

37. Simple cut-in: the image

Note the orientation of the inner circle. If the orientation would be different the contour would be self-intersecting. This becomes immediately apparent if you try to perturb the contour to convert it to a simple contour.

#### 4.10.4.8 Fully Coincident Segments

The first example below illustrates how one contour may result in two regions. This happens because there are two fully coincident linear segments which give the gap between filled areas.



**Example:**

```
G04 ex1: non overlapping*
%FSLAX24Y24*%
%MOMM*%
%ADD10C,1.00000*%
G01*
%LPD*%
G36*
X0Y50000D02*
Y100000D01*
X100000D01*
Y0D01*
X0D01*
Y50000D01*
G04 first fully coincident linear segment*
X-10000D01*
X-50000Y10000D01*
X-90000Y50000D01*
X-50000Y90000D01*
```

```
X-10000Y50000D01*  
G04 second fully coincident linear segment*  
X0D01*  
G37*  
M02*
```

This creates the following image:

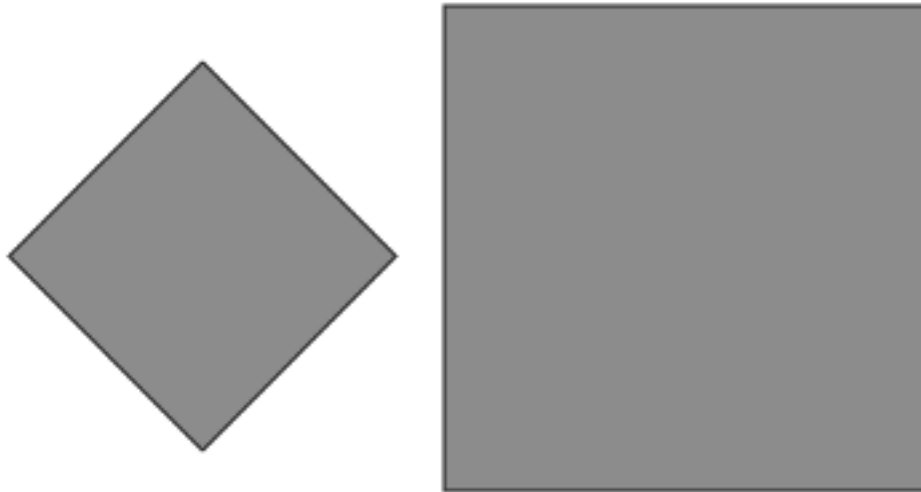

38. Fully coincident segments in contours: two regions

The second example illustrates how one contour allows creating region with hole.



**Example:**

```
G04 ex2: overlapping*  
%FSLAX24Y24*%  
%MOMM*%  
%ADD10C,1.00000*%  
G01*  
%LPD*%  
G36*  
X0Y50000D02*  
Y100000D01*  
X100000D01*  
Y0D01*  
X0D01*  
Y50000D01*  
G04 first fully coincident linear segment*  
X10000D01*  
X50000Y10000D01*  
X90000Y50000D01*  
X50000Y90000D01*  
X10000Y50000D01*  
G04 second fully coincident linear segment*  
X0D01*
```

G37\*  
M02\*

This creates the following image:

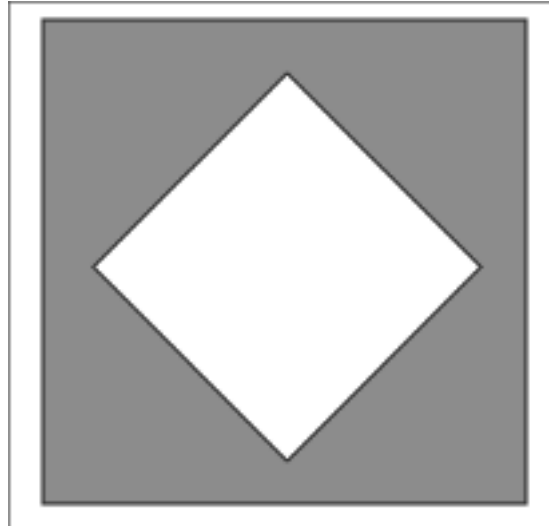

39. Fully coincident segments in contours: region with hole

#### 4.10.4.9 Valid and Invalid Cut-ins

Contours with cut-ins are susceptible to rounding problems: when the vertices move due to the rounding the contour may become self-intersecting. This may lead to unpredictable results. The first example below is a cut-in with valid fully coincident segments, where linear segments which are on top of one another have the *same* end vertices. When the vertices move due to rounding, the segments will remain exactly on top of one another, and no self-intersections are created. This is a valid and robust construction.



#### Example:

```
G36*  
X1220000Y2570000D02*  
G01*  
Y2720000D01*  
X1310000D01*  
Y2570000D01*  
X1250000D01*  
Y2600000D01*  
X1290000D01*  
Y2640000D01*  
X1250000D01*  
Y2670000D01*  
X1290000D01*  
Y2700000D01*  
X1250000D01*  
Y2670000D01*  
Y2640000D01*  
Y2600000D01*  
Y2570000D01*
```



X1220000D01\*  
G37\*

This results in the following contour:

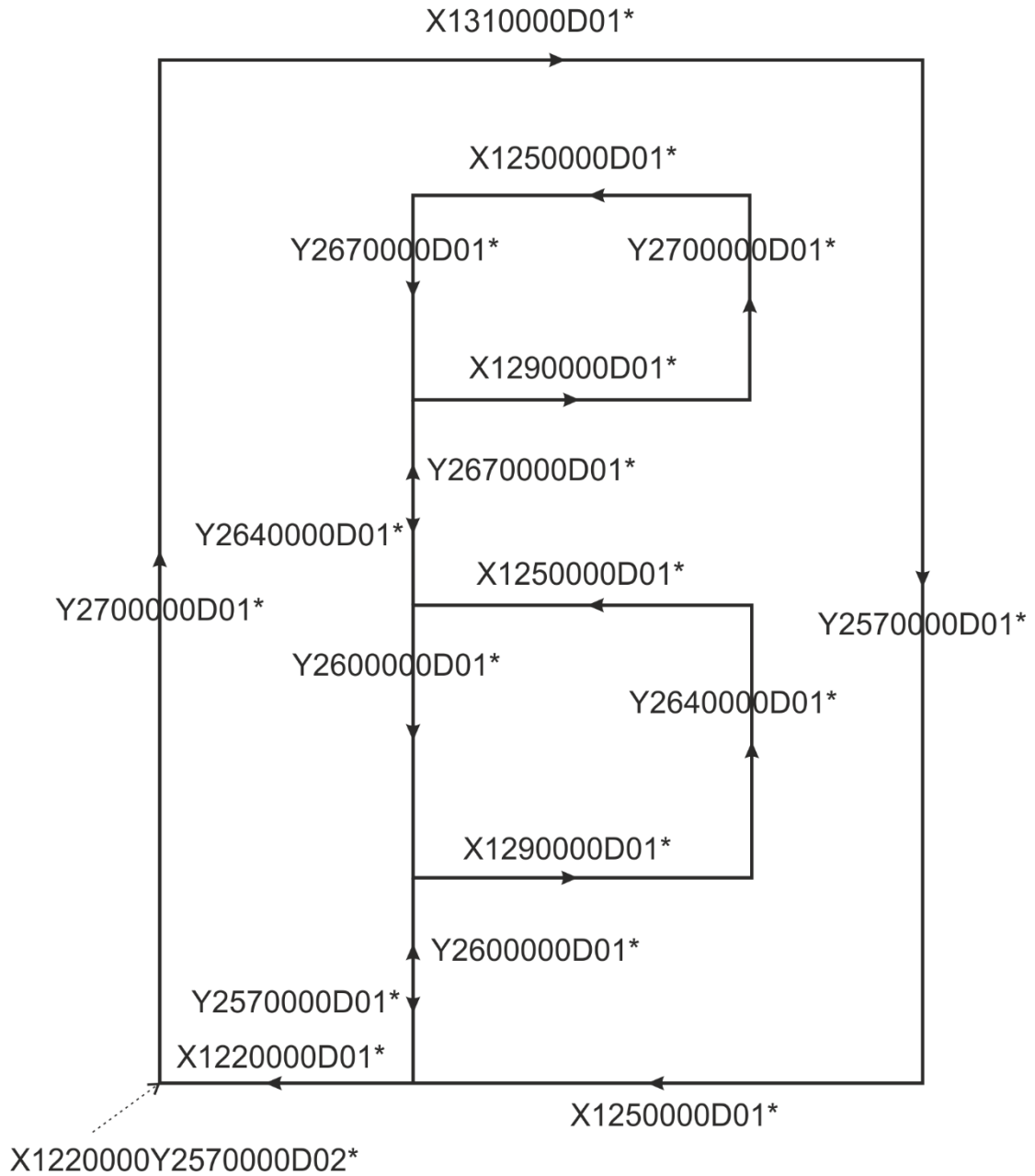

*40. Valid cut-in: fully coincident segments*

This creates the following image:

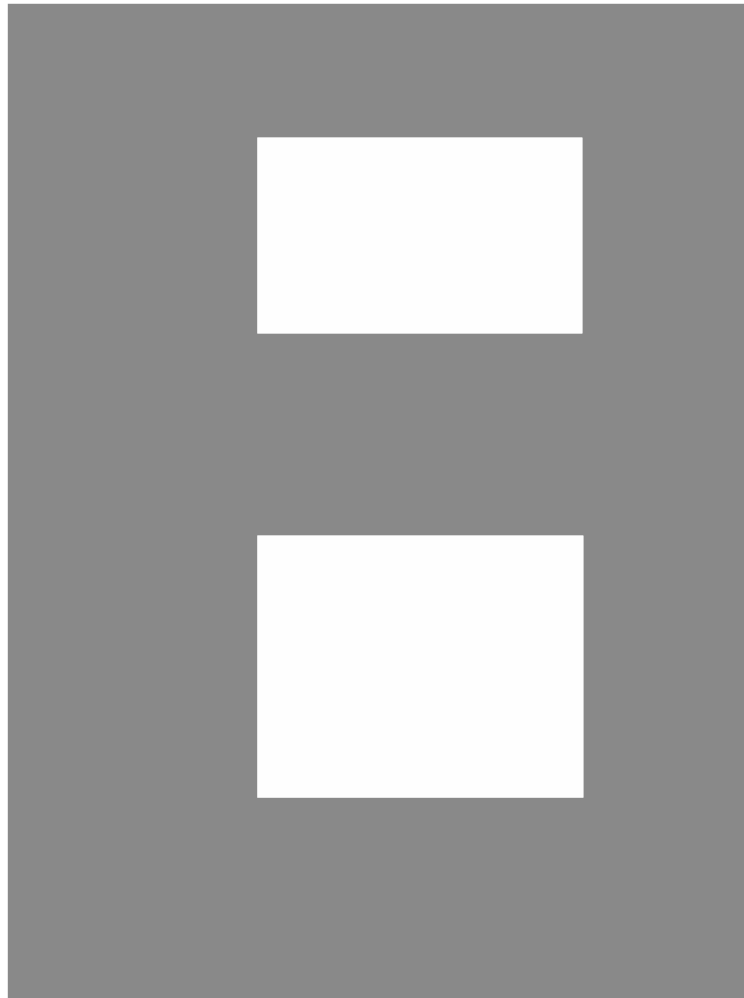

#### 41. Valid cut-in: resulting image

The next example attempts to create the same image as the first example from above, but it is *invalid* due to the use of invalid partially coinciding segments (see the description of a valid contour in 4.10.3). The number of linear segments has been reduced by eliminating vertices between collinear segments, creating invalid overlapping segments. This construction is *invalid*. It is prohibited because it is not robust and hard to handle: when the vertices move slightly due to rounding, the segments that were on top of one another may become intersecting, with unpredictable results.



#### Example:

```
G36*  
X1110000Y2570000D02*  
G01*  
Y2600000D01*  
X1140000D01*  
Y2640000D01*  
X1110000D01*  
Y2670000D01*  
X1140000D01*  
Y2700000D01*  
X1110000D01*
```

Y2570000D01\*  
X1090000D01\*  
Y2720000D01\*  
X1170000D01\*  
Y2570000D01\*  
X1110000D01\*  
G37\*

This results in the following contour:

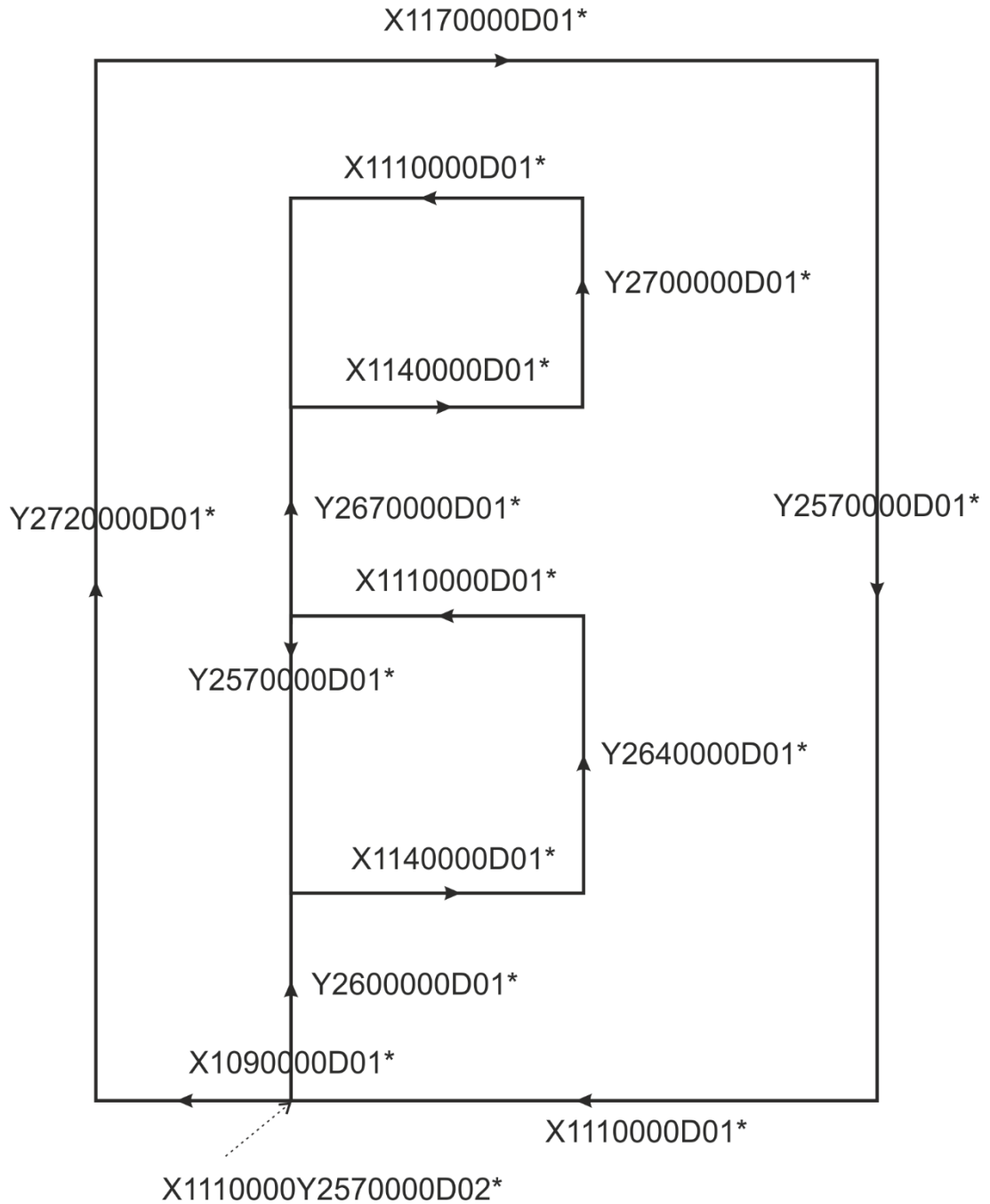

#### 42. Invalid cut-in: overlapping segments

## 4.10.5 Copper Pours, Power and Ground Planes

The simplest way to construct power and ground planes is first to create the copper pour with a region in dark polarity (LPD), and then erase the clearances by switching to clear polarity (LPC). Note the clear polarity objects erase everything under them, so the copper pours and clearances are best output first.



### Example:

```
G04 We define the antipad used to create the clearances*
%TA.AperFunction, AntiPad*%
%ADD11C...*%
...
G04 We now define the copper pour as a region*
LPD*
G36*
X...Y...D02*
X...Y...D01*
...
G37*
G04 We now flash clearances*
%LPC*%
D11*
X...Y...D03*
```

This is simple and clear. In CAD the location of the anti-pads and other clearances is known. Outputting these directly transfers shape and location information to CAM in a simple way.

Clearances in power and ground planes can also be constructed with cut-ins, as below.

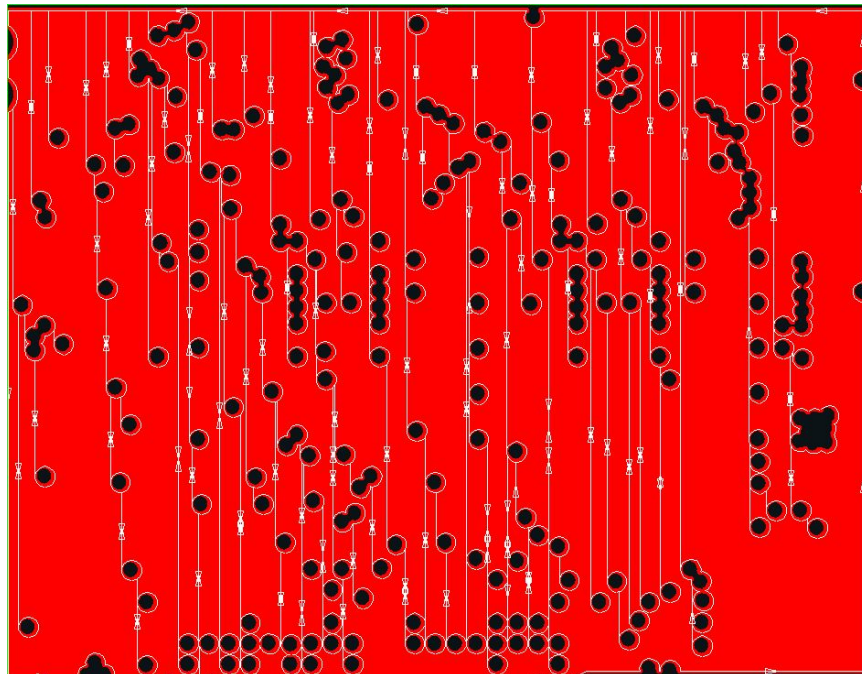

43. Power and ground planes with cut-ins.

The cut-ins are rather complex to create on output; in CAM the cut-ins must be removed on input and the original clearances restored, again rather complex. Avoid this more complex construction if at all possible.

Care must be taken to only create valid cut-ins. Sloppy cut-ins are the most frequent cause of scrap due to faulty Gerber files, causing a self-intersecting contour and a missing clearance. Below is an example of such sloppy cut-in; it is a real-life example that lead to expensive scrap. Watch out for rounding errors. Make sure that coincident points indeed are coincident in the file. With the highest resolution on outputs reduces rounding errors.

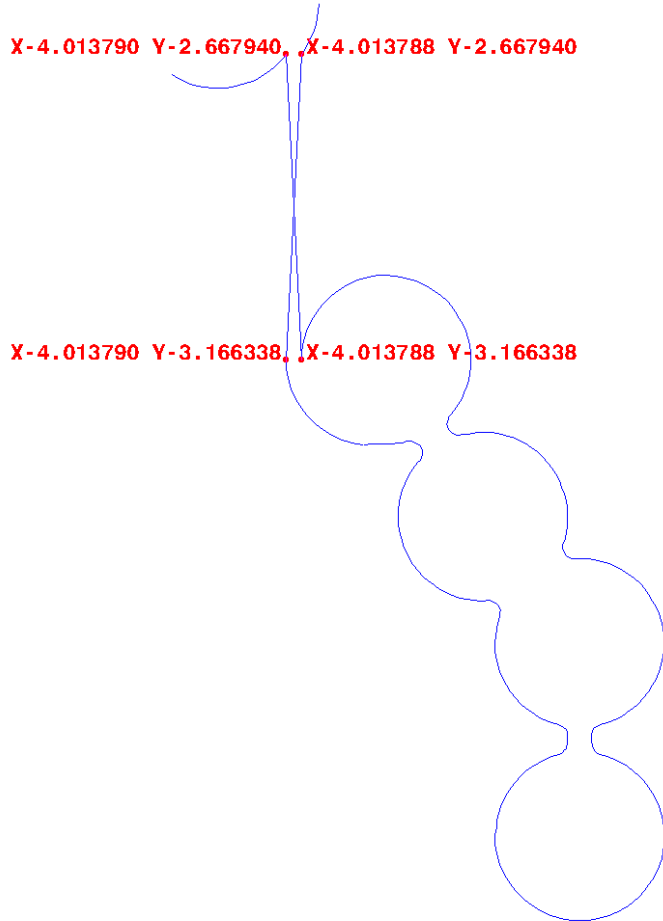

44. Power plane with invalid cut-in.

It is sometimes recommended to avoid the cut-ins altogether by splitting the plane in separate pieces, where no piece has holes. Do not follow this terrible recommendation. The remedy is worse than the disease. Splitting the single contour in separate contours without holes is as complex as adding cut-ins. All clearance boundaries must be cut in pieces and split over different contours; not much of an improvement over finding cut-in points. Rounding errors still lurk, and can lead to pieces that are no longer connected; not much of an improvement over invalid cut-ins. The situation is far worse on input. If the plane consists of a single contour it is clear it is a single plane. When planes are split in pieces the coherence is lost. The file reader must figure out from a bewildering set of contours that a single plane is intended. It must recover clearances which boundaries are scattered over different contours. Cutting a plane in pieces to avoid clearances is bad practice. It is asking for problems. See also 4.14.

## 4.11 Block Aperture (AB)

### 4.11.1 Overview of block apertures

The AB command creates a *block aperture*. The command stream between the opening and closing AB command defines a block aperture which is stored in the aperture dictionary. Thus the AB commands add an aperture to the dictionary directly, without needing an AD command. The LM, LR, LS and LP commands affect the flashes of block apertures in as any other aperture: when a block aperture is flashed, it is first transformed according to the transformation parameters in the graphics state and then added to the object stream.

The origin of the block aperture is the (0,0) point of the file.

A block aperture is not a single graphical object but a set of objects. While a standard or macro aperture always adds a single graphical object to the stream, a block aperture can add any number of objects, each with their own polarity. Standard and macro apertures always have a single polarity while block apertures can contain both dark and clear objects.

If the polarity is dark (LPD) when the block is flashed then the block aperture is inserted as is. If the polarity is clear (LPC) then the polarity of all objects in the block is toggled (clear becomes dark, and dark becomes clear). This toggle propagates through all nesting levels. In the following example the polarity of objects in the flash of block D12 will be toggled.

```
%ABD12*%
...
%AB*%
...
D12*
%LPC*%
X-2500000Y-1000000D03*
```

A D03 of a block aperture updates the current point but otherwise leaves the graphics state unmodified, as with any other aperture.

The AB command was introduced in revision 2016.12

### 4.11.2 AB Statement Syntax

The syntax for the AB command is:

**<AB command> = AB[<block aperture number>]\***

Syntax	Comments
AB	AB for Aperture Block. Opens/closes an AB statement.
<block aperture number>	The aperture number under which the block is stored in the aperture dictionary.

#### Examples:

Syntax	Comments
%ABD12*%	Opens the definition of aperture D12
%AB*%	Closes the current AB statement.

The section between the opening and closing AB commands can contain nested AB commands. The resulting apertures are stored in the library and are available subsequently until the end of the file, also outside the enclosing AB section. The syntax is:

```
AB_statement = AB_open {in_block_statement}* AB_close;
```

```
AB_open =   '%' ('AB' aperture_ident) '**%';
```

```
AB_close =  '%' ('AB') '**%';
```

```
in_block_statement =
```

```
  |single_statement
```

```
  |region_statement
```

```
  |AB_statement
```

```
  ;
```

```
single_statement =
```

```
  | operation
```

```
  | interpolation_state_command
```

```
  | Dnn
```

```
  | G04
```

```
  | attribute_command
```

```
  | AD
```

```
  | AM
```

```
  | coordinate_command
```

```
  | transformation_state_command
```

```
  ;
```

Consequently, an AB statement can contain embedded AB statements. The scope of names defined by an AB statement is the whole file.

The current point is *undefined* after an AB statement.

### 4.11.3 Usage of Block Apertures

The main purpose of block apertures is to repeat a sub-image without the need to repeat all the generating commands. Block apertures can be repeated at *any* location and *individually* mirrored, rotated and scaled. Block apertures are more powerful than the SR command: the SR only allows repeats on a regular grid, without mirror, rotate or scale, and, crucially, without nesting. Blocks are typically used to create panels without duplicating the data.

The second purpose of block apertures is to complement macro apertures. A block aperture consisting of a single region creates a single object with one polarity– as with standard or macro apertures. Thus, single object apertures of any shape can easily be created. Such a block aperture can be used to define pads. Blocks are simpler to create than macros. However, macros can have parameters and blocks cannot. On the other hand, a macro outline primitive support only linear segments while the contours in blocks support both linear and circular segments.

Do not use blocks – or macros - when a standard aperture is available. Standard apertures are built-in and therefore are processed faster.

## 4.11.4 Example



### A complete Gerber file with nested blocks

```
G04 Ucamco copyright*
%TF.GenerationSoftware,Ucamco,UcamX,2016.04-160425*%
%TF.CreationDate,2016-04-25T00:00;00+01:00*%
%TF.Part,Other,Testfile*%
%FSLAX46Y46*%
%MOMM*%
G04 Define standard apertures*
%ADD10C,7.500000*%
%ADD11C,15*%
%ADD12R,20X10*%
%ADD13R,10X20*%
G04 Define block aperture 100, consisting of two draws and a round dot*
%ABD100*%
D10*
X65532000Y17605375D02*
Y65865375D01*
X-3556000D01*
D11*
X-3556000Y17605375D03*
%AB*%
G04 Define block aperture 102, consisting of 2x3 flashes of aperture 101
and 1 flash of D12*
%ABD102*%
G04 Define nested block aperture 101, consisting of 2x2 flashes of
aperture 100*
%ABD101*%
D100*
X0Y0D03*
X0Y700000000D03*
X100000000Y0D03*
X100000000Y700000000D03*
%AB*%
D101*
X0Y0D03*
X0Y160000000D03*
X0Y320000000D03*
X230000000Y0D03*
X230000000Y160000000D03*
X230000000Y320000000D03*
D12*
X19500000Y-10000000D03*
%AB*%
G04 Flash D13 twice outside of blocks*
D13*
X-30000000Y10000000D03*
```



```
X143000000Y-30000000D03*  
G04 Flash block 102 3x2 times*  
D102*  
X0Y0D03*  
X0Y520000000D03*  
X500000000Y0D03*  
X500000000Y520000000D03*  
X1000000000Y0D03*  
X1000000000Y520000000D03*  
M02*
```

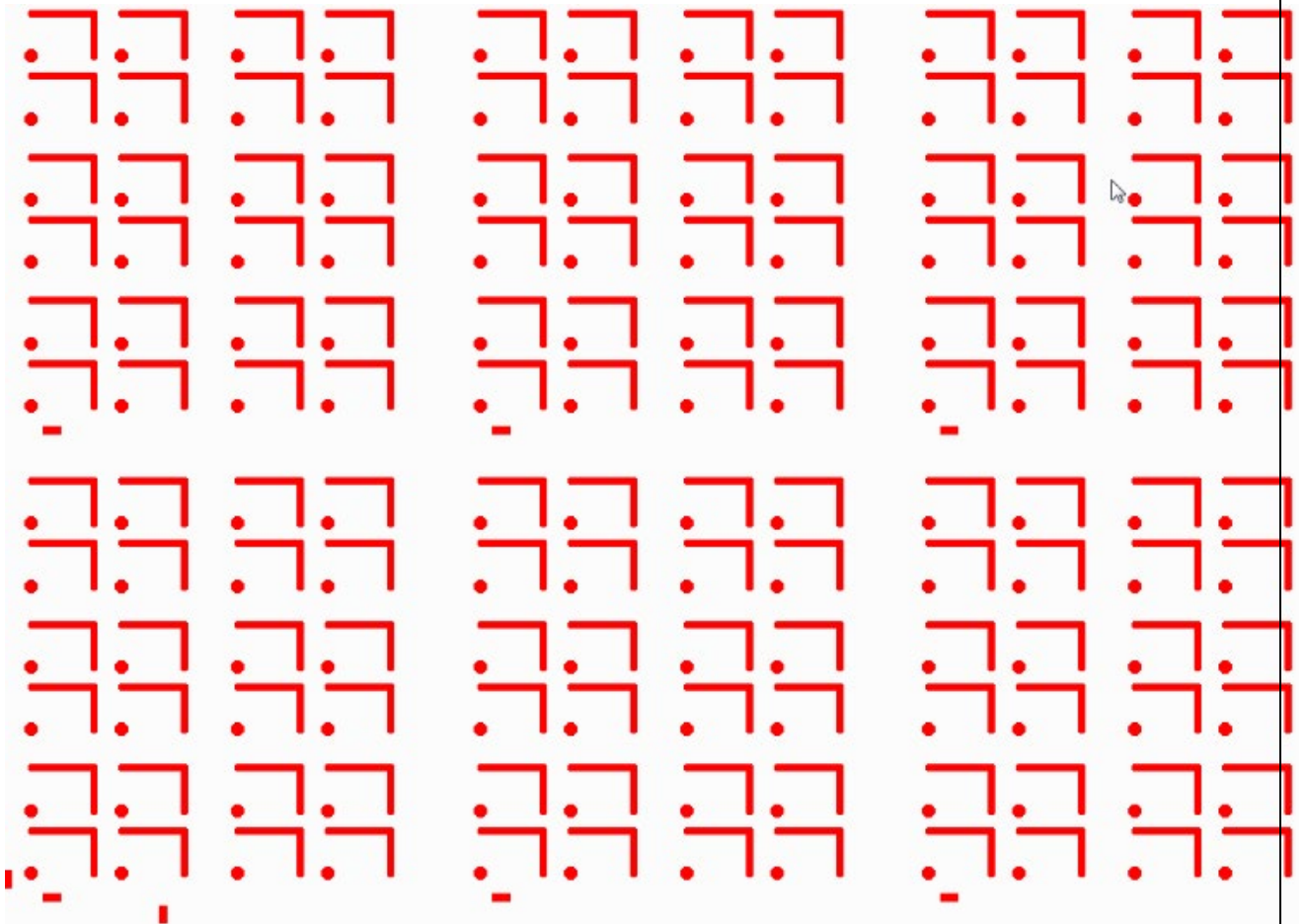

45. Block aperture example 1

## 4.12 Step and Repeat (SR)

The purpose of the SR command is to replicate a set of graphical objects without replicating the commands that creates the set.

The SR command `%SRX...Y...I...J...*%` opens an *SR statement*. All subsequent commands are part of the SR statement until it is closed by an `%SR*%`. The parameters X, Y specify the number of repeats in X and Y and I, J their respective step distances. The graphical objects generated by the command stream in a SR statement are collected in a *block* - see 2.8 - instead of being added directly to the object stream. When the SR command is closed by an `%SR*%`, the block is step-repeated (replicated) in the image plane according to the parameters X, Y, I and J in the opening SR command. Blocks are copied first in the positive Y direction and then in the positive X direction. The syntax for the SR command is:

**<SR command> = SR[X<Repeats>Y<Repeats>I<Distance>J<Distance>]\***

Syntax	Comments
SR	SR for Step and Repeat
X<Repeats>	Defines the number of times the block is repeated along the X axis. <Repeats> is an integer $\geq 1$
Y<Repeats>	Defines the number of times the block is repeated along the Y axis. <Repeats> is an integer $\geq 1$
I<Distance>	Defines the step distance along the X axis. <Distance> is a decimal number $\geq 0$ , expressed in the unit of the MO command
J<Distance>	Defines the step distance along the Y axis. <Distance> is a decimal number $\geq 0$ , expressed in the unit of the MO command

Examples:

Syntax	Comments
<code>%SRX2Y3I2.0J3.0*%</code>	Opens an SR statement and starts block accumulation. When block accumulation is finished the block will be repeated 2 times along the X axis and 3 times along the Y axis. The step distance between X-axis repeats is 2.0 units. The step distance between Y-axis repeats is 3.0 units.
<code>%SRX4Y1I5.0J0*%</code>	Opens an SR statement and starts block accumulation. When block accumulation is finished the block will be repeated 4 times along the X axis with the step distance of 5.0 units. The step distance in the J parameter is ignored because no repeats along the Y axis are specified.
<code>%SR*%</code>	Closes the SR statement and repeats the previously accumulated block

The syntax is:

```

SR_statement = SR_open {in_block_statement}* SR_close;
SR_open =   '%' ('SR' 'X' positive_integer 'Y' positive_integer 'I' decimal 'J'
decimal) '**%';
SR_close =  '%' ('SR') '**%';
in_block_statement =
  |single_statement
  |region_statement
  |AB_statement
  ;
single_statement =
  | operation
  | interpolation_state_command
  | Dnn
  | G04
  | attribute_command
  | AD
  | AM
  | coordinate_command
  | transformation_state_command
  ;

```



**Example:**

```

G04 A block of two flashes is repeated 3x2 times*
%SRX3Y2I5.0J4.0*%
D13*
X123456Y789012D03*
D14*
X456789Y012345D03*
%SR*%

```

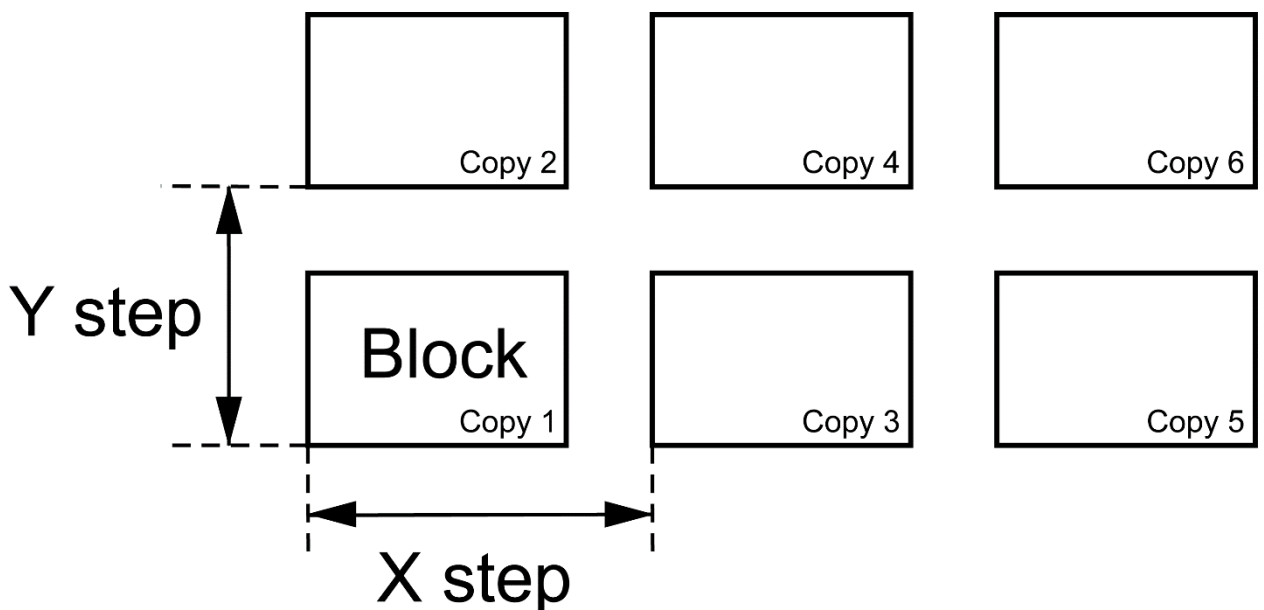

## *46. Blocks replication with SR command*

Note that a block contains the graphical objects, not the Gerber source code. The graphical objects in each copy are always identical, even if the graphics state is modified during the SR statement.

The current point is undefined after an SR statement.

A file can contain multiple SR statements. The number of steps and the step distances can be different in X and Y. The number of repeats along an axis can be one; it is then recommended to use the step distance 0.

A step & repeat block can contain different polarities (LPD and LPC – see 4.9.2). A clear object in a block clears *all* objects beneath it, including objects outside the block. When repeats of blocks with both dark and clear polarity objects overlap, the step order affects the image; the correct step order must therefore be respected: step the complete block first in Y and then in X.

## 4.13 End-of-file (M02)

The M02 command indicates the end of the file. The syntax is as follows:

**M02 = ('M02') '\*';**



### Example:

M02\*

The last command in a Gerber file *must* be the M02 command. No data is allowed after an M02. Gerber readers are encouraged to give an error on a missing M02 as this is an indication that the file has been truncated.

Note that a block or region statement must be explicitly closed. Consequently, an M02 command *cannot* be issued *within* a block or region statement.

## 4.14 Numerical Accuracy

The coordinates of all points and all geometric parameters (e.g. a diameter) have an exact numerical value. Graphical objects are therefore in principle defined with infinite precision with the exception of arcs, which are intrinsically slightly fuzzy (see 4.7.2.). A Gerber file specifies an image with infinite precision.

However, Gerber file writers cannot assume that file readers will process their files with infinite precision as this is simply impossible. *Nemo potest ad impossibile obligari*. This raises the question to what a Gerber file reader is held, and what a Gerber writer *can* assume.

### 4.14.1 Visualization

Gerber files are often used to *visualize* an image on a screen, a photoplotter, a direct imager. Visualization is unavoidably constrained by the limitations of the output device. Nonetheless, visualization must comply with the following rules:

- ❑ Each individual graphical object must be rendered within the stated accuracy of the output device.
- ❑ No spurious holes may appear - solid objects must be visualized solid.
- ❑ No spurious objects may appear.
- ❑ Zero-size objects are *not* visualized.
- ❑ Graphical objects can be rendered individually, without considering neighboring objects. In other words, each graphical object is handled individually, regardless of context.

It is intentionally not specified if rendering must be “fat” or “thin” - fat meaning that features below the device accuracy are blown up to be visible, thin meaning that they disappear.

These rules have several noteworthy consequences:

- ❑ Gerber objects separated by a very small gap may touch in the visualized image.
- ❑ Gerber objects that touch or marginally overlap may be separated by a gap in the visualized image.
- ❑ Gerber objects smaller or thinner than the device resolution may totally disappear in the visualized image.
- ❑ When what is intended to be a single object is broken down into simpler graphical objects, and these elementary objects do not sufficiently overlap, the resulting image may *not* be solid - it may have internal holes or even break up in pieces. To avoid these effects the best and most robust approach is not to break up the single object at all: the Gerber format has powerful primitives to create almost any shape with a single graphical object or possible a succession of dark and clear objects.

**Construct files robustly.**

### 4.14.2 Image Processing

Gerber files are processed for visualization but often also to complex image processing algorithms: e.g. etch compensation, design rule checks in CAM and so on. These algorithms perform long sequences of numerical calculations. Rounding errors unavoidably accumulate. Coordinates can move and object sizes can vary. The specification limits the allowed perturbation to  $[-0.5\mu\text{m}, +0.5\mu\text{m}]$ ; furthermore coincident coordinates must remain coincident. The writer can assume that the perturbation is within this limit. Higher accuracy cannot be blindly assumed; if it is needed it must be checked that the applications downstream can handle this. A file is therefore only robust if, under any allowed perturbation, it remains valid and represents the same image.

The perturbation has some noteworthy consequences:

- Contours that are not self-intersecting by a margin of  $\leq 1\mu\text{m}$  can become self-intersecting under a valid perturbation. Such contours are therefore invalid; see section 4.10.3. Contours must be constructed robustly so that allowed processing perturbations do not turn an otherwise valid contour in a self-intersecting one. See 4.14.2. Consequently, points and segments that are not coincident must be separated by at least  $1\mu\text{m}$ . Furthermore, circular segments add their own intrinsic fuzziness, see 4.7.2. If any valid interpretation of the arc violates the requirement of  $1\mu\text{m}$  separation the contour is invalid. Construct contours defensively. Observe sufficient clearances. Marginal contours can and do lead to problems
- Objects that touch or overlap marginally can become separated under perturbation. This is important for electrical connection. An electrical connection that is realized by touching objects can get separated by a valid perturbation. Such marginal construction can be validly interpreted as either isolating or connecting. Make proper and robust electrical connections, with an overlap of the order of magnitude of at least the minimum conductor width.
- Arcs with end points separated by less than  $1\mu\text{m}$  can toggle between very small or nearly 360 degrees under valid perturbations. Do not write such arcs.
- Avoid objects smaller than  $1\mu\text{m}$ .

**Construct files robustly.**

# 5 Attributes

## 5.1 Attributes Overview

Attributes add meta-information to a Gerber file. Attributes are akin to labels providing information about the file or features within them. Examples of meta-information conveyed by attributes are:

- ❑ The function of the file in the layer structure. Is the file the top solder mask, the bottom copper layer, ...?
- ❑ The function of a pad. Is the pad an SMD pad, or a via pad, or a fiducial, ...?

The attribute syntax provides a flexible and standardized way to add meta-information to a Gerber file, independent of the specific semantics or application.

Attributes do *not* affect the image. A Gerber reader will generate the correct image if it simply ignores the attributes.

Each attribute consists of an *attribute name* and an optional *attribute value*:

**<Attribute> = <AttributeName>[,<AttributeValue>]\***

Attribute names follow the name syntax in section 3.4.3.

The attribute value consists of one or more comma-separated fields, see section 3.4.4.

**<AttributeValue> = <Field>{,<Field>}**

There are three types of attributes by the *item* they attach to:

Attachment type	The item to which they attach meta-information
File attributes	Attach meta-information to the file as a whole.
Aperture attributes	Attach meta-information to an aperture or a region. Objects created by the aperture inherit the aperture meta-information
Object attributes	Attach meta-information to on object directly

There are two types of attributes by the *scope* of their use:

- ❑ *Standard attributes*. Standard attribute names, values and semantics are defined in this specification and are part of it. As they are standardized, they can exchange meta-information between all applications.
- ❑ *User attributes*. User attributes can be chosen freely by users to extend the format with custom meta-information. Use custom attributes only for unequivocally defined machine-readable information, use G04 for mere human-readable comments.

In accordance with the general rule in 3.4.3 standard attribute names *must* begin with a dot '.' while user attribute names *cannot* begin with a dot. The dot, if present, is part of the attribute name and indicates that it is a standard attribute whose syntax and semantics are defined in section 5.6.



Example of a user attributes:

```
%TFMyAttribute, Yes*%
```

```
%TFZap*%
```

```
%TFZonk*%
```



The following commands govern attributes. (They start with a T as the more obvious A is already taken by the aperture commands.)

Command	Description	Section
TF	Attribute file. Set a file attribute.	5.2
TA	Attribute aperture. Add an aperture attribute to the dictionary or modify it.	5.3
TO	Attribute object. Add an object attribute to the dictionary or modify it.	5.4
TD	Attribute delete. Delete one or all attributes in the dictionary.	5.5

The syntax is as follows:

```

TF = '% ('TF' attribute_name {',' attribute_value}*) '**%';
TA = '% ('TA' attribute_name {',' attribute_value}*) '**%';
TO = '% ('TO' attribute_name {',' attribute_value}*) '**%';
TD = '% ('TD' [attribute_name]) '**%';
attribute_name = field;
attribute_value = field;

```

During the processing of a Gerber file an *attribute dictionary* is maintained. Dictionary entries consist of the attribute name, its domain and its value. The attribute name is the key of the entry; it must consequently be unique, even for attributes with a different domain.

The current aperture dictionary is defined after each command by the following rules:

- ❑ Initially the attribute dictionary is empty
- ❑ File attributes are added with the TF command
- ❑ Aperture attributes are added or updated with the TA command
- ❑ Object attributes are added or updated with the TO command
- ❑ Attributes are deleted with the TD command

When an aperture or a graphical object is created all attributes with the proper domain present in the dictionary at the time of creation are attached to it. They remain fixed and cannot be changed.

In the following example the command TF defines an attribute with name “.FileFunction” and value composed of the two fields: “Soldermask,Top”.



Example:

```
%TF.FileFunction,Soldermask,Top*%
```

Note that attribute commands are not allowed *within* a region statement, see 4.10.2.

## 5.2 File Attributes (TF)

File attributes provide meta-information about entire files.

The semantics of a file attribute specifies where it must be defined, typically in the header of the file. A file attribute can only be defined once. It cannot be redefined.

File attributes are set with the uppercase TF command with the following syntax

**<TF command> = %TF<AttributeName>[,<AttributeValue>]\*%**

**<AttributeValue> = <Field>{,<Field>}**

The attribute name must follow the syntax in section 3.4.3, fields this in 3.4.4. The name is unique and cannot be used for any other attribute, even of another type.



### Example:

```
%TF.FilePolarity,Negative*%
```

## 5.3 Aperture Attributes (TA)

An *aperture attribute* is attached to an aperture or a region. They are a method to assign attributes to graphical objects in bulk: all objects that are created with an aperture inherit its attributes; for example, a via attribute on an aperture means that all pads flashed with this aperture are via pads. Providing information about graphical objects via their apertures is elegant, compact and efficient. As region objects are created without intermediary aperture, aperture objects can be assigned to regions directly.

The TA command adds an aperture attribute into the attributes dictionary. It has the following syntax:

**<TA command> = %TA<AttributeName>[,<AttributeValue>]\*%**

**<AttributeValue> = <Field>{,<Field>}**

The attribute name must follow the syntax in section 3.4.3, fields the one in 3.4.4. The name must be unique. The value of an aperture attribute can be modified by a new TA with the same attribute name.

The example below defines several attributes.



### Example:

```
%TA.AperFunction,ComponentPad*%
%TAMyApertureAttributeWithValue,value*%
%TAMyApertureAttributeWithoutValue*%
```

In the next example the aperture value is initially set to `ComponentPad` and later overruled to `ViaPad`.



### Example:

```
%TA.AperFunction,ComponentPad*%
...
%TA.AperFunction,ViaPad*%
```

When an AD or an AB command creates an aperture all aperture attributes then in the attribute dictionary are attached to it. Once an aperture is defined its attributes cannot be changed.

## 5.3.1 Aperture Attributes on Regions

Counter-intuitively, aperture attributes can be attached to regions. When a G36/G37 creates a region all aperture attributes in the dictionary are attached to it, in the same way as they are attached to an aperture created with an AD command. A way to view this is that the G36 command creates a virtual region aperture and attaches attributes to it in the same way as an AD. Regions effectively function as single-use apertures that are flashed and immediately forgotten when the region definition is completed.

Aperture attributes on regions are necessary. Aperture attributes are a way to attach properties to objects such as draws or flashes. It is sometimes necessary to attach the same property to region objects. For example, the function 'conductor' must be assigned both to tracks – draws – and copper pours – regions. For the tracks this is done with an aperture attribute, a convenient way to attach an attribute to a larger number of objects. For the regions this is done with the mechanism in the first paragraph.

Note that aperture attributes are *not* attached directly to draws, arcs and flashes, because there it is done indirectly via their aperture.



### Example: Define a copper pour as a region

```
%TA.AperFunction, Conductor*%
G36*
X118151529Y-78573554D02*
G01*
X118230607Y-78626393D01*
X118283446Y-78705471D01*
X118302000Y-78798750D01*
X118302000Y-79286250D01*
...
X118151529Y-78573554D01*
G37*
```

For the avoidance of doubt: regions take the aperture attributes from the dictionary, not from the current aperture.

## 5.4 Object Attributes (TO)

An *object attribute* is attached to graphical objects. When a D01, D03 or region statement (G36/G37) creates an object all object attributes in the attribute dictionary are attached to it. As attribute commands are not allowed inside a region statement, *all* regions created by that statement have the same object attributes. Once attached to an object they cannot be changed.

The TO command adds an object attribute into the attributes dictionary. It has the same syntax as the TF command:

**<TO command> = %TO<AttributeName>[,<AttributeValue>]\*%**

**<AttributeValue> = <Field>{,<Field>}**

The attribute name must follow the syntax in section 3.4.3, fields the one in 3.4.4. The name is unique and cannot be used for any other attribute, even of another type. The value of an object attribute can be modified by a new TO command with the same attribute name.



### Example:

```
%TO.C, R6*%
```

## 5.5 Delete Attribute (TD)

The TD command deletes an attribute from the attributes dictionary. Note that the attribute remains attached to apertures and objects to which it was attached before it was deleted.

**<TD command> = %TD[<AttributeName>]\*%**

The <AttributeName> is the name of the attribute to delete. If omitted, the whole dictionary is cleared.

## 5.6 Standard Attributes

### 5.6.1 Overview

Name	Usage	Section	Attached to
.Part	Identifies the part the file represents, e.g. a single PCB	5.6.2	File
.FileFunction	Identifies the file's function in the PCB, e.g. top copper layer	5.6.3	File
.FilePolarity	Positive or Negative. This defines whether the image represents the presence or absence of material.	5.6.4	File
.SameCoordinates	All files in a fabrication data set with this attribute use the same coordinates. In other words, they align.	5.6.5	File
.CreationDate	Defines the creation date and time of the file.	5.6.6	File
.GenerationSoftware	Identifies the software creating the file.	5.6.7	File
.ProjectId	Defines project and revisions.	5.6.8	File
.MD5	Sets the MD5 file signature or checksum.	5.6.9	File
.AperFunction	Function objects created with the apertures, e.g. SMD pad	5.6.10	Aperture
.DrillTolerance	Tolerance of drill holes	5.6.11	Aperture
.FlashText	When a flash represents text, this provides the original text, font etc.	5.6.12	Aperture
.N	The CAD net name of a conducting object, e.g. Clk13.	5.6.13	Graphical object
.P	The pin number (or name) and reference descriptor of a component pad on an outer layer, e.g. IC3,7.	5.6.14	Graphical object
.C	The component reference designator linked to an object, e.g. C2.	5.6.15	Graphical object

*Table with the standard attributes*

Attributes are not needed when the image only needs to be rendered. However, attributes are needed in PCB fabrication data, when transferring PCB data from design to fabrication. For example, the fabricator needs to know exactly which copper represents a via pad to handle the solder mask properly. The standard attributes transfer the design intent from CAD to CAM in an unequivocal and standardized manner. This is sometimes rather grandly called “adding

intelligence to the image”. Without standard attributes the design intent must be gathered from various documents, unwritten rules, conversations or reverse engineering, with all the risks of error and delay that this entails.

It is strongly recommended to use standard attributes as comprehensively as possible. If you cannot provide *all* the attributes or are unsure of their use then provide all the attributes you are comfortable with. Partial information is better than no information. For professional PCB production the bare minimum is to set .FileFunction and .FilePolarity.

Note that standard attribute values typically contain a value “Other” to cater to requirements not yet foreseen in the specification. The intention is to add new values as the need arises to reduce the use of “Other” over time.

We are open to your suggestions for new generally useful attributes. Please contact Ucamco at [gerber@ucamco.com](mailto:gerber@ucamco.com) to request it. Authors will be properly acknowledged when their suggestions are included in the standard.



**Warning: Do not invent your own standard attribute names** (names starting with a dot). This would defeat the purpose of standardization. User attributes cater to specific needs that are not covered by the standard attributes. Feel free to invent any user attribute you wish.

## 5.6.2 .Part

The value of the .Part file attribute identifies which part is described. The attribute – if present - must be defined in the header.

.Part value	Usage
Single	Single PCB
Array	A.k.a. customer panel, assembly panel, shipping panel, biscuit
FabricationPanel	A.k.a. working panel, production panel
Coupon	A test coupon
Other, <mandatory field>	None of the above. The mandatory field informally indicates the part

*.Part file attribute values*



### Example:

```
%TF.Part,Array*%
```

### 5.6.3 .FileFunction

The .FileFunction file attribute identifies the function of the file in the PCB layer structure. Of all the attributes it is the most important.



#### Example:

```
%TF.FileFunction,Copper,L1,Top*%
```

The attribute must be defined in the header.

The existence of a file function does not mean that it must be included in each PCB fabrication data sets. Include the files that are needed: no more, no less.

The file functions are designed to support all file types in current use. If a type you need is missing please contact us at [gerber@ucamco.com](mailto:gerber@ucamco.com).

<b>Data layers</b>	
<b>.FileFunction value</b>	<b>Usage</b>
<code>Copper,L&lt;p&gt;, (Top Inr Bot) [, &lt;type&gt;]</code>	<p>A conductor or copper layer.</p> <p>L&lt;p&gt; (p is an integer&gt;0) specifies the physical copper layer number. Numbers are consecutive. The top layer is always L1. (L0 does <i>not</i> exist.) The mandatory field (<i>Top Inr Bot</i>) specifies it as the top, an inner or the bottom layer; this redundant information helps in handling partial data. The specification of the top layer is “<code>Copper,L1,Top[, type]</code>”, of the bottom layer of an 8 layer job it is <code>Copper,L8,Bot[, type]</code></p> <p>The top side is the one with the through-hole components, if any.</p> <p>The optional &lt;type&gt; field indicates the layer type. If present it must take one of the following values: <i>Plane, Signal, Mixed</i> or <i>Hatched</i>.</p>
<code>Plated,i,j, (PTH Blind Buried) [, &lt;label&gt;]</code>	<p>Plated drill/rout data, span from copper layer i to layer j. The from/to order is not significant. The (PTH Blind Buried) field is mandatory.</p> <p>The label is optional. If present it must take one of the following values: <i>Drill, Rout</i> or <i>Mixed</i>.</p>
<code>NonPlated,i,j, (NPTH Blind Buried) [, &lt;label&gt;]</code>	<p>Non-plated drill/rout data, span from copper layer i to layer j. The from/to order is not significant. The (NPTH Blind Buried) field is mandatory.</p> <p>The label is optional. If present it must take one of the following values: <i>Drill, Rout</i> or <i>Mixed</i>.</p>



Profile, (P NP)	<p>A file containing the board profile (or outline) and only the board profile. Such a file is mandatory in a PCB fabrication data set. See 6.5.</p> <p>The mandatory (P NP) label indicates whether board is edge-plated or not.</p>
Soldermask, (Top Bot) [, <index>]	<p>Solder mask or solder resist.</p> <p>Usually the image represents the solder mask <i>openings</i>; it then has negative polarity, see 5.6.4.</p> <p>The optional field is only needed when there is more than one solder mask on one side – top or bottom. The integer &lt;index&gt; then numbers the solder masks from the PCB side outwards, starting with 1 for the mask directly on the copper. Usually there is only one solder mask on a side, and then &lt;index&gt; is omitted. An example with two top solder masks:</p> <p>Soldermask, Top, 1 ← Mask on the copper</p> <p>Soldermask, Top, 2 ← Mask on the first mask</p>
Legend, (Top Bot) [, <index>]	<p>A legend is printed on top of the solder mask to show which component goes where. A.k.a. ‘silk’ or ‘silkscreen’.</p> <p>See Soldermask for the usage of &lt;index&gt;.</p>
Component, L<p>, (Top Bot)	<p>A layer with component information.</p> <p>L&lt;p&gt; The integer p is the copper layer number to which the components described in this file are attached. (Top Bot) indicates if the components are on top, upwards, or on the bottom, downward, of the layer to which they are attached. This syntax caters for embedded components.</p> <p>For jobs without embedded components there is an intentional redundancy.</p>
Paste, (Top Bot)	Locations where solder paste must be applied.
Glue, (Top Bot)	Glue spots to fix components prior to soldering.
Carbonmask, (Top Bot) [, <index>]	See Soldermask for the usage of <index>.
Goldmask, (Top Bot) [, <index>]	See Soldermask for the usage of <index>.
Heatsinkmask, (Top Bot) [, <index>]	See Soldermask for the usage of <index>.
Peelablemask, (Top Bot) [, <index>]	See Soldermask for the usage of <index>.

Silvermask, (Top Bot) [, <index>]	See Soldermask for the usage of <index>.
Tinmask, (Top Bot) [, <index>]	See Soldermask for the usage of <index>.
Depthrout, (Top Bot)	Area that must be routed to a given depth rather than going through the whole board.
Vcut [, (Top Bot) ]	Contains the lines that must be v-cut. (V-cutting is also called scoring.)  If the optional attachment (Top Bot) is not present the scoring lines are identical on top and bottom – this is the normal case. In the exceptional case scoring is different on top and bottom two files must be supplied, one with Top and the other with Bot.
Viafill	Contains the via's that must be filled. It is however recommended to specify the filled via's with the optional field in the .AperFunction ViaDrill.
Pads, (Top Bot)	A file containing only the pads (SMD, BGA, component, ...). Not needed in a fabrication data set.
Other, <mandatory field>	Another data layer then the ones above. The mandatory field informally describes it.
<b>Drawing layers</b>	
<b>.FileFunction value</b>	<b>Usage</b>
Drillmap	A drawing with the locations of the drilled holes. It often also contains the hole sizes, tolerances and plated/non-plated info.
FabricationDrawing	An auxiliary drawing with additional information for the fabrication of the bare PCB: the location of holes and slots, the board outline, sizes and tolerances, layer stack, material, finish, etc.
Vcutmap	A drawing with v-cut or scoring information.
AssemblyDrawing, (Top Bot)	An auxiliary drawing with the locations and reference designators of the components. It is mainly used in PCB assembly.
ArrayDrawing	A drawing of the array (biscuit, assembly panel, shipment panel, customer panel).
OtherDrawing, <mandatory field>	Any other drawing than the five ones above. The mandatory field describes its topic.

*.FileFunction attribute values*



## **Examples. File functions of a four layer board (One for each Gerber file):**

```
%TF.FileFunction,Legend,Top*%  
%TF.FileFunction,Soldermask,Top*%  
%TF.FileFunction,Copper,L1,Top*%  
%TF.FileFunction,Copper,L2,Inr,Plane*%  
%TF.FileFunction,Copper,L3,Inr,Plane*%  
%TF.FileFunction,Copper,L4,Bot*%  
%TF.FileFunction,Soldermask,Bot*%  
%TF.FileFunction,NonPlated,1,4,NPTH,Drill*%  
%TF.FileFunction,NonPlated,1,4,NPTH,Rout*%  
%TF.FileFunction,Plated,1,4,PTH*%  
%TF.FileFunction,Profile,NP*%  
%TF.FileFunction,Drillmap*%
```

## 5.6.4 .FilePolarity

The .FilePolarity specifies whether the image represents the *presence or absence* of material.

The .FilePolarity attribute does *not* change the image - no attribute does. It changes the interpretation of the image. For example, in a copper layer in positive polarity a round flash generates a copper *pad*. In a copper layer in negative polarity it generates a *clearance*.

The .FilePolarity attribute must be defined in the header.

.FilePolarity value	Usage
Positive	The image represents the <i>presence</i> of material (recommended)
Negative	The image represents the <i>absence</i> of material

*.FilePolarity attribute values*



### Example 1:

```
%TF.FileFunction,Copper,L2,Inr,Plane*%
%TF.FilePolarity,Positive*%
```



**Warning:** *Solder mask layers are nearly always negative.* Solder mask layers typically represent the mask openings, or the *absence* of solder mask, and are therefore *negative*. This may be counter intuitive as such masks are so ubiquitous to be regarded as normal, and positive is also regarded as normal.



### Example2:

```
%TF.FileFunction,Soldermask,Top*%
%TF.FilePolarity,Negative*%
```

Drill and rout files indicate where the drill bit hits and therefore always positive. It is recommended output copper layers in positive. Power/ground planes in negative made sense in the 1970s and 1980s to get around the limitations in the vector photoplotters of that age but there is no longer any reason for negative today.

## 5.6.5 .SameCoordinates

All layers in a PCB fabrication data set must use the same coordinate system – the origin and orientation of the axes must be the same. Data in different layers then aligns: the pads, drill holes, pads and solder mask openings of a pad stack all have the same coordinates.

This is obvious but unfortunately layers sometimes layers are flipped or origins shifted. The fabricator consequently cannot trust the incoming data and must reverse-engineer the layer alignment. Unfortunately. This uncertainty can lead to scrap with boards where wrong alignment is not obvious, such as very symmetric or HF boards.

The .SameCoordinates attribute tells the fabricator that the alignment is correct.

The attribute must be defined in the header. The syntax is as follows:

```
%TF.SameCoordinates[,<ident>]*%
```



### Example – without ident:

```
%TF.SameCoordinates*%
```

If this attribute is present in a number of Gerber files in a PCB fabrication data set then these files are in alignment with each other.



### Example – with a GUID as ident:

```
%TF.SameCoordinates,f81d4fae-7dec-11d0-a765-00a0c91e6bf6*%
```

The ident is optional. Its purpose is the following. Files in the fabrication data can be output at different times, and in between the CAD origin may have changed. In that situation simply outputting the attribute would wrongly signal the layers do align. The ident distinguishes between these different coordinate systems at output time. Files with the same ident align, files with different idents don't necessarily. The ident can be freely chosen, but the GUID is recommended. When all files have the same coordinates, the ident is not needed.

Note that all data files must align anyhow, attribute or no attribute.

## 5.6.6 .CreationDate

The .CreationDate file attribute identifies the moment of creation of the Gerber file.

The attribute – if present - must be defined in the header. The attribute value must conform to the full version of the ISO 8601 date and time format, including the time zone. A formally defined creation date can be helpful in tracking revisions – see also 5.6.8



### Example:

```
%TF.CreationDate,2015-02-23T15:59:51+01:00*%
```

## 5.6.7 .GenerationSoftware

The .GenerationSoftware file attribute identifies the software that generated the Gerber file. The field <vendor> identifies the organization that supplies the generating software to its users; this can be a commercial company, an open source organization, etc.

The attribute – if present - must be defined in the header. The syntax is as follows:

```
%TF.GenerationSoftware,<vendor>,<application>[,<version>]*%
```



### Example:

```
%TF.GenerationSoftware,Ucamco,UcamX,2017.04*%
```

## 5.6.8 .ProjectId

Usually a Gerber file is part of a PCB project with a sequence of revisions. The purpose of the .ProjectId file attribute is to uniquely identify project and revision. This is especially important to check whether all files belong to the same revision. By its nature, these values can only be defined by the creator of the project and revision.

The attribute – if present - must be defined in the header. The syntax is as follows:

```
%TF.ProjectId,<Name>,<GUID>,<Revision>*%
```

The field <Name> is the id or reference used by the design owner, <GUID> defines the project using a global unique ID and <Revision> specifies its revision. All parameters must conform to the field syntax, see 3.4.4. The <GUID> is a field conforming to RFC4122 version 1 or version 4.



### Examples:

```
%TF.ProjectId,My PCB,f81d4fae-7dec-11d0-a765-00a0c91e6bf6,2*%
```

```
%TF.ProjectId,project#8,68753a44-4D6F-1226-9C60-0050E4C00067,/main/18*%
```

## 5.6.9 .MD5

The .MD5 file attribute sets a file signature (checksum, hash, digest) that uniquely identifies the file and provides a high degree of security against accidental modifications.

The .MD5 checksum is not intended for CAD to CAM data transfer which is probably sufficiently protected by the checksum of the zip, but rather for individual files used within fabrication, with a bewildering collection of legacy systems and protocols, and where file transmission errors sometimes occur.

The 128 bit signature is calculated with the MD5 algorithm and expressed as a 32 digit hexadecimal number (see <https://en.wikipedia.org/wiki/MD5>). The signature is calculated over the bits from the beginning of the file up to but excluding the .MD5 file attribute command itself. Note that this excludes the closing M02\*. The complete .MD5 file attribute command, with both '%' and '\*', is excluded. Any CR and LF are excluded from signature calculation. As CR and LF do not affect the interpretation of the file but may be altered when moving platforms excluding them makes the signature portable without sacrificing security.

The signature, if present, must be put at the end of the file, just before the closing M02\*. Thus the file can be processed in a single pass.



### Example:

Consider the following Gerber file segment, without checksum:

```
...
D11*
X1500000Y2875000D03*
X2000000D03*
D19*
X2875000Y2875000D03*
M02*
```

As the CR and LF characters are skipped the checksum is taken over the following data:

```
...D11*X1500000Y2875000D03*X2000000D03*D19*X2875000Y2875000D03*
```

With the checksum the file then becomes:

```
...
D11*
X1500000Y2875000D03*
X2000000D03*
D19*
X2875000Y2875000D03*
%TF.MD5,6ab9e892830469cdf7e3e346331d404*%
M02*
```

<- Excluded from the MD5

<- Excluded from the MD5

The following Perl script specifies precisely how the .MD5 is calculated:

```
#script expects one parameter (original Gerber X2 file)
use Digest::MD5;
local $_ = shift;
local *IN;
my $content;

local $/;
open(IN, "<$_") or die "Cannot open $_ due to $!";
$content = <IN>;          #read file to the variable
close IN;
$content =~ s/\r|\n//g; #remove all CRLF (end of line) characters
$content =~ s/M02\*//;  #remove M02 from the end of file

#calculate MD5
$md5 = Digest::MD5->new; #init MD5
$md5->add($content);     #send content of the file to MD5 engine

print "Add 2 following lines to the Gerber file, please.\n";
print "%TF.MD5,";
print $md5->hexdigest;   #print correct MD5 hash
print "*%\nM02*\n\n";
```

### 5.6.10 .AperFunction

The .AperFunction aperture attribute defines the *function* or purpose of an aperture, or rather the graphical objects created with it. PCB CAM needs to know the function of graphical objects, especially pads. If this is not possible define the function of all attributes then at least define if for those where you can - partial information is better than no information. The bare minimum is to identify via pads: the PCB fabricator must know where the via pads are.

**One function, one aperture.** Objects with different functions must be created with different apertures, even if they have the same shape and size. Apertures with objects with mixed functions are devilishly hard to handle in CAM: the CAM engineer but must check each individual object to determine which action to take. It is far more efficient and secure to do this per aperture. This also applies to drill tools: suppose via and component holes have the same size; vias and component holes need different tool compensations; when they are separate tools the compensation can be done per tool; when they use the same tool the CAM engineer must laboriously go over each drill to determine whether it is a via or a component hole, and compensate accordingly.

**Regions.** Counterintuitively, regions can carry aperture attributes, see 5.3.1. Use .AperFunction to define the function of the regions.

**Painted pads and painted copper pours (aka vector-fill).** How to set attributes on painted pads or copper pours? Simple. Replace the painting with proper flashes or regions and then proceed as in this specification.

The .AperFunction values are defined in the tables below. Note that an attribute value typically applies to specific layers only - for example, an SMD pad can only be defined on outer copper layers.

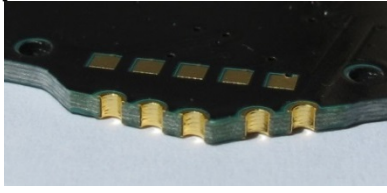

Drill and rout layers	
.AperFunction value	Usage
ViaDrill[, <IPC-4761>] <IPC-4761>= (Ia   Ib   IIa   IIb   IIIa   IIIb   IVa   IVb   V   VI   VII   None)	<p>A via hole, a plated hole whose <i>sole</i> function is to connect different layers, where there is no intention to insert component leads or mechanical objects.</p> <p>An optional field specifies the via protection according to IPC-4761</p>
BackDrill	<p>A hole to remove plating over a sub-span by drilling that sub-span with a larger diameter.</p>
ComponentDrill [, PressFit]	<p>A hole that is used for the attachment and/or electrical connection of component terminations, including pins and wires, to a printed board. (Per IPC-T-50). The attribute applies to drill holes and rout slots.</p> <p>The optional label PressFit indicates drill holes for press fit leads. Press fit leads are pressed in properly sized plated-through holes to realize the electrical contact. The label can only be applied on PTH holes.</p> <p>See also ComponentPad.</p>
MechanicalDrill [, (Tooling Breakout Other)]	<p>A hole with mechanical function (registration, screw, etc.) It applies to drill holes and rout slots. The specifier is optional. If present it can take one of the following values:</p> <ul style="list-style-type: none"> <li>• <b>Tooling</b>: Holes placed on a PCB or a panel of PCBs for registration and hold-down purposes during the manufacturing process.. Also called mounting holes.</li> <li>• <b>BreakOut</b>: Non-plated holes forming a break-out tab used in break routing.</li> </ul> <div style="text-align: center;">  </div> <ul style="list-style-type: none"> <li>• <b>Other</b></li> </ul> <p><b>Example:</b>            .AperFunction, MechanicalDrill, Breakout            .AperFunction, MechanicalDrill</p>

CastellatedDrill	<p>Plated holes cut- through by the board edge; used to join PCBs.</p>  <p style="text-align: right; font-size: small;">Image courtesy Eurocircuits.</p>
OtherDrill, <mandatory field>	A hole, but none of the above. The mandatory field informally describes the type.
<b>Copper layers</b>	
<b>.AperFunction value</b>	<b>Usage</b>
ComponentPad	<p>A pad associated with a <i>component hole</i>. The pads around a ComponentDrill <i>on all layers</i> take the value ComponentPad although indeed on inner layers they only have a via function. In other words, the pad attribute value follows the drill tool attribute value.</p> <p>Only for through-hole components; SMD and BGA have their own dedicated type.</p> <p>See also ComponentDrill.</p>
SMDPad, (CuDef SMDef)	<p>A pad belonging to the footprint of an <i>SMD component</i>, whether the corresponding lead is connected or not. Applies only for the normal electrical pads, thermal pads have their own function; see HeatsinkPad.</p> <p>BGA pads which have their own type.</p> <p>The specifier (CuDef SMDef) is <i>mandatory</i>. CuDef stands for <i>copper defined</i>; it is by far the most common SMD pad; the copper pad is completely free of solder mask; the area to be covered by solder paste is defined by the copper pad. SMDef stand for <i>solder mask defined</i>; the solder mask overlaps the copper pad; the area to be covered by solder paste is defined by the solder mask opening and not by the copper pad. (CuDef is sometimes rather awkwardly called <i>non solder mask defined</i>.)</p> <p>Only applicable for outer layers.</p> <p>When an SMD pad contains a via hole the pad where the SMD is soldered, on the outer layer with the SMD, is SMDPad, all other pads in the stack are ViaPad. If the SMD pad contains an embedded via pad, as it should, then that embedded pad is of course ViaPad.</p>

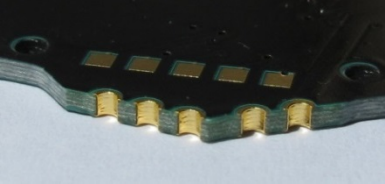
<p>BGAPad, (CuDef SMDef)</p>	<p>A pad belonging to the footprint of a <i>BGA component</i>, whether the corresponding lead is connected or not.</p> <p>The specifier (CuDef SMDef) is <i>mandatory</i>. CuDef stands for <i>copper defined</i>, SMDef for <i>solder mask defined</i>; see SMDPad.</p> <p>Only applicable for outer layers.</p> <p>When a BGA pad contains a via hole the pad where the BGA is soldered is BGAPad, all other pads in the stack are ViaPad. If the BGA pad contains an embedded via pad, as it should, then that embedded pad is of course ViaPad.</p>
<p>ConnectorPad</p>	<p>An edge connector pad.</p> <p>Only applicable for outer layers.</p>
<p>HeatsinkPad</p>	<p>Heat sink or thermal pad, typically for SMDs</p>
<p>ViaPad</p>	<p>A via pad. It provides a ring to attach the plating in the barrel. This is reserved for pads that have <i>no other function</i> than making the connection between layers: For example component pads often also have a via function however they must have the Component function.</p>
<p>TestPad</p>	<p>A test pad. Only applicable for outer layers.</p> <p>Sometimes a test pad is drilled and also has a via function, to save space. Such a pad <i>must</i> be specified as test pad. (It is clear from the construction that it has a via function, but the fabricator must know it is a test pad, and this is not obvious. Similarly, a component pad can also function as a via, but it remains a component pad.)</p>
<p>CastellatedPad</p>	<p>Pads on plated holes cut- through by the board edge; used to join PCBs.</p>  <p style="text-align: right; font-size: small;">Image courtesy Eurocircuits.</p>
<p>FiducialPad , (Local Global Panel)</p>	<p>A fiducial pad.</p> <p>The specifier (Local Global Panel) is <i>mandatory</i>. Local fiducials pads are used to locate the position of an individual component, global to locate a single PCB, and Panel to locate a panel.</p>
<p>ThermalReliefPad</p>	<p>A thermal relief pad connected to the surrounding copper while restricting heat flow.</p>

WasherPad	A pad around a non-plated hole without electrical function. Several applications, e.g. a pad that strengthens the PCB where fixed with a bolt – hence the name washer.
AntiPad	A pad with clearing polarity (LPC) creating a clearance in a plane. It makes room for a drill pass without connecting to the plane. Note that setting the AntiPad attribute itself has no effect on the image, and therefore does not turn the pad into LPC as a side effect– this must be done explicitly by an %LPC*% command.
OtherPad, <mandatory field>	A pad not specified above. The mandatory field informally describes the type.
Conductor	Copper whose function is to connect pads or to provide shielding, typically tracks and copper pours such as power and ground planes. Conductive copper pours must carry this attribute.
EtchedComponent	Etched components are embedded inductors, transformers and capacitors which are etched into the PCB copper. The following illustration shows two etched inductors:  For the CAD netlist these are components like others: the net names are different on both sides. (However, for bare-board electrical test they may be conducting copper and connect the net on both sides.)
NonConductor	Copper that does not serve as a conductor, that has no electrical function; typically text in the PCB such as a part number and version. This attribute can only be applied to copper, not to drawing elements in a copper layer; see also NonMaterial and Profile.
CopperBalancing	Copper pattern added to balance copper coverage for the plating process.
Border	The copper border of a production panel.
OtherCopper, <mandatory field>	Indicates another function. The mandatory field informally describes it.
Profile	See the section All layers below
NonMaterial	

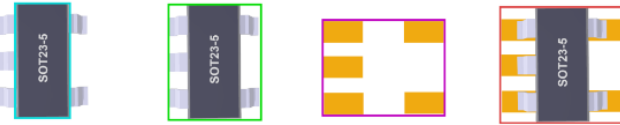
Material	
Other, <mandatory field>	
Component layers	
.AperFunction value	Usage
ComponentMain	<p>This aperture is flashed at the centroid of a component. The .C object attribute <i>must</i> be attached to the flash to identify the reference descriptor. The flash carries .Cxxx object attributes with the characteristics of the component. See also 6.9.</p> <p>The following aperture must be used:</p> <p style="margin-left: 40px;">%ADDnnC, 0.300*% (mm)</p> <p style="margin-left: 40px;">%ADDnnC, 0.012*% (in)</p> <p>nn is an aperture number, an integer ≥ 10.</p>
ComponentOutline, <type> <type>= (Body Lead2Lead Footprint Courtyard)	<p>This aperture is use to draw the outline of the component. The .C object attribute <i>must</i> be attached to each draw/arc to identify the reference descriptor. See also 6.9.</p> <p>Four different types of outlines are defined. See drawing, courtesy Thiadmer Riemersma:</p> <div style="text-align: center;">  <p style="display: flex; justify-content: space-around; font-size: small;"> <span>body size</span> <span>lead-to-lead size</span> <span>footprint contour</span> <span>courtyard</span> </p> </div> <p>Outlines of different types on the same component are allowed.</p> <p>The outline is drawn with is a sequence of connected draws and arcs (D01). They are said to connect only if they are defined consecutively, with the second starting where the first one ends. Thus, the order in which they are defined is significant. A outline is closed: the end point of the last draw/arc must coincide with the start point of the first. Outlines cannot self-intersect. The following aperture must be used:</p> <p style="margin-left: 40px;">%ADDnnC, 0.100*% (mm)</p> <p style="margin-left: 40px;">%ADDnnC, 0.004*% (in)</p>

ComponentPin	<p>This aperture is used to identify pin (or lead) locations. The coordinates in the flash command (D03) indicate the location of the component pins (leads). A .P object attribute <i>must</i> be attached to each ComponentPin flash to identify the reference descriptor and pin number; the .N object attribute <i>may</i> be attached. See also 6.9.</p> <p>For the key pin, typically pin "1" or "A1", the following diamond shape aperture <i>must</i> be used:  <code>%ADDnnP,0.360X4X0.0*% (mm)</code>  <code>%ADDnnP,0.017X4X0.0*% (in)</code></p> <p>The key pin is then visible in the image.</p> <p>For all other pins the zero size aperture <i>must</i> be used:  <code>%ADDnnC,0*%...</code> (both mm and in)</p> <p>These pins are then not visible to avoid cluttering the image.</p>
Profile	See the section All layers below
NonMaterial	
Material	
Other, <mandatory field>	
<b>All data layers</b>	
<b>.AperFunction value</b>	<b>Usage</b>
Profile	Identifies the draws and arcs that exactly define the profile or outline of the PCB. This is the content of the Profile file but can also be present in other layers. See 6.5
NonMaterial	The attribute value NonMaterial identifies objects that do not represent physical material but drawing elements. NonMaterial is only meaningful on files that define the pattern of physical layers of a PCB such as copper layers or solder mask. Such files unfortunately sometimes not only contain data representing material but also drawing elements such as a frame and a title block. (Note: drawing elements should not be mixed with pattern data, see 6.6.2. Use separate drawing layers for drawings.).
Material	<p>Identifies the proper part of the data file.</p> <p>Solder masks are traditionally negative. The image represents the solder mask openings. The apertures take the value 'Material' – they define solder mask material, but in a negative way.</p> <p>For copper and drill layers Material is split into more specific functions such as SMD pad. Use the specific functions when available rather than 'Material'.</p>

Other, <mandatory field>	<p>The value 'Other' is to be used if none of the values above fits. By putting the value 'Other' rather than crudely omitting the attribute it is made explicit that the value is none of the above – an omitted attribute can be one of the above. Certainly do not abuse existing values by horseshoeing an attribute with a vaguely similar function into that value that does not fit perfectly – keep the identification clean by using 'Other'.</p> <p>The mandatory field informally describes the aperture function.</p>
--------------------------	---

*.AperFunction attribute values*

**Functions on extra layers.** The solder mask, paste and other extra layers openings *cannot* take the pad values. Pad values are reserved for outer copper layers. The solder mask openings and paste pads take their function from the underlying copper pads. The reason for this is that a single solder mask opening may have multiple underlying copper pads – e.g. an SMP pad with an embedded via pad - and hence multiple functions.

Consequently, solder mask openings have the aperture function 'Material'. Admittedly this is somewhat a misnomer in this context as solder masks are usually negative, and the presence of image indicates therefore the absence of material; this has nothing to do with the pad functions but with the layer being negative.

The following file creates a circular hole in the solder mask. In negative file polarity the image represents the absence of material.

```
%FSLAX36Y36*%
%MOMM*%
%TF.FileFunction,Soldermask,Top*%
%TF.Part,Single*%
%TF.FilePolarity,Negative*%
%TA.AperFunction,Material*%
%ADD10C,2.54*%
%LPD*%
D10*
X123500000Y12500D0003*
...
M02*
```

If the file polarity is positive an otherwise identical file creates a circle consisting of solder mask.

```
%FSLAX36Y36*%
%MOMM*%
%TF.FileFunction,Soldermask,Top*%
%TF.Part,Single*%
%TF.FilePolarity,Positive*%
%TA.AperFunction,Material*%
%ADD10C,2.54*%
%LPD*%
D10*
X123500000Y125000000D03*
...
M02*
```

## 5.6.11 .DrillTolerance

.DrillTolerance defines the plus and minus tolerance of a drill hole end diameter. Both values are positive decimals expressed in the MO units. The attribute value has the following syntax:

<plus tolerance>,<minus tolerance>



### Examples:

```
%TA.DrillTolerance,0.01,0.005*%
```

## 5.6.12 .FlashText

Gerber intentionally does not contain fonts or typographic text – this would introduce a complexity out of proportion to its benefits. Any text can be represented with the available



graphic constructs, especially with contours. However, such generic graphic constructs do not maintain the information about which text string is represented.

The .FlashText aperture attribute transfers this otherwise lost information. .FlashText is designed for text image created with a flash. If the text is created with draws and arcs rather than a flash, it can always be flashed by collecting them in a block aperture.

Bar codes are handled as text – one can view a barcode as a special font.

The syntax and semantic of the attribute value is as follows:

<Text>,(B|C),[(R|M)],[<Font>],[Size],[<Comment>]

.FlashText fields	Usage
<text>	The text string represented by the aperture image.
(B C)	Indicates if the text is represented by a <i>barcode</i> – B -or by <i>characters</i> - C.
(R M)	Indicates if the text is readable or mirrored left-right . Optional.
<Font>	Font name. Content not standardized. Optional.
<Size>	Font size. Content not standardized. Optional.
<Comments>	Any extra information one wants to add. Optional.

An empty field means that the corresponding meta-data is not specified.

**Examples:**

```
%TA.FlashText,L1,C,R,Courier,10,Layer number (L1 is top)*%
```

Text: L1  
 B|C: Characters,  
 (R|M): Readable  
 Font: Courier  
 Size: 10  
 Comment: Layer number (L1 is top)

```
%TA.FlashText,XZ12ADF,B,,Code128,,Project identifier *%
```

Text: XZ12ADF  
 B|C: Barcode  
 (R|M) Not specified  
 Font: Code128  
 Size: Not specified  
 Comment: Project identifier

## 5.6.13 .N (Net)

The .N object attribute attaches a CAD netlist name to any conducting object. The attribute can be attached to objects on any copper layer or plated drill/rout file and to ComponentMain or ComponentPin objects on component layers. It indicates the object is part of the given net. The .N attribute is intended to allow quick visualization of nets and, more importantly, to define the CAD netlist.

The syntax is:

**<.N Attribute> = .N,<netname>{,<netname>}**

.N field	Usage
<netname>	The CAD net name. It can take any value conforming to the field syntax.



### Example:

```
%TA.aperFunction,Conductor*%
%ADD21C,1*%           Create aperture 21, for conductive tracks
...
D21*                 Select aperture 21
%TO.N,Clk3*%         Select net Clk3
X5600000Y1200000D02* Move to the start of a track
X5600000Y1202500D01* Draw the tracks with Clk3 is attached
X5605000Y1205000D01*
X5605000Y1220000D01*
...
```

There are two reserved net names:

- 1) The empty string, defined by %TO.N,\*% identifies objects not connected to a net, such as tooling holes, text, logos, pads for component leads not connected to the component circuitry.
- 2) The name N/C, defined by %TO.N,N/C\*%, identifies a single pad net, as an alternative to giving each such net a unique name.

Except the reserved names all net names must be unique.

It is recommended to attach a .N attribute to all copper objects, also those without net. The absence of the .N attribute does not mean there is no net and is therefore ambiguous.

Normally an object is fully connected and consequently belongs to a single net. However, if an object consists of different disconnected parts or is split in several disconnected parts by clear (LPC) objects it may belong to different nets. Then the .N attribute value must include all net names involved. It is recommended to avoid creating disconnected objects: one object, one net.

### 5.6.13.1 Etched Components

Etched components are embedded inductors, transformers and capacitors which are etched into the PCB copper. The following illustration shows two etched inductors.



They are identified by the .AperFunction attribute value 'EtchedComponent' on to the aperture used to create them. See `EtchedComponent`.

For the CAD netlist these are components like others: the net names are different on both sides. (However, for bare-board electrical test they may be conducting copper and simply connect the nets on both sides.)

Etched components do not need and normally do not have pads. There is no .P associated with them. The net on each side is different however.

## 5.6.14 .P (Pin)

The .P object attribute attaches the reference descriptor and pin number of a component pin to a pad on an outer copper layer or a ComponentPin in a component layer. The syntax is:

**<.P Attribute> = .P,<refdes>,<number>[,<function>]**

.P fields	Usage
<refdes>	The component reference descriptor. It can take any value conforming to the field syntax.
<number>	The pin number. It can take any value conforming to the field syntax. It is normally simply a number but it can actually be any name.
<function>	The pin function. It can take any value conforming to the field syntax. It is strongly recommended to include <i>both</i> pin number and pin function. The pin function is less prone to error than the pin number, and the redundancy provides extra security This is especially important for diodes and transistors.



### Example:

Take the following integrated circuit:

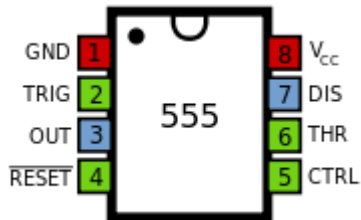

The pin attributes could be as follows:

```
D13*                               Select aperture 13 for the pads for IC12
%TO.P, IC12, 1, GND*%
X5600000Y1200000D03*               The Pad for IC12, pin 1, GND
%TO.P, IC12, 2, TRIG*%
X5600000Y1202500D03*               The Pad for IC12, pin 2, TRIG
...
```



### Example (pin number only):

```
D13*                               Select aperture 13 for the pads for R5
%TO.P, R5, 1*%
X5600000Y1200000D03*               The pad for R5, pin 1
%TO.P, R5, 2*%
X5600000Y1202500D03*               The pad for R5, pin 2
...
```

The .P attribute can be attached to any pad belonging to a component pin, and only to those. (The pin number must be a non-empty field except if the pad is part of the component footprint but not connected to the component circuitry, e.g. %TO.P,U3,\*%; pads with an empty number are normally not part of a net and therefore also have an empty net name defined by %TO.N,\*%.) Consequently, .P can only be used on *component layers* and on *copper layers* that carry the components - typically the outer layers, but also inner layers with embedded or etched components.

A single component pad can consist of multiple flashes. Each flash then carries the same reference descriptor and pin number.

It is technically possible to create a single object representing multiple pads. For example, a single macro aperture can describe a complete component footprint. This is possible but *not allowed*. (It would be a neat way to make life miserable for CAM engineers though.)

### 5.6.15 .C (Component Refdes)

The .C object attribute attaches the component reference descriptor to an object. It indicates that the object belongs to the given component. It can be attached to objects on any layer. It is intended to identify e.g. which objects in a legend belong to which components.

The syntax is:

**<.C Attribute> = .C,<refdes>**

.C field	Usage
<refdes>	The component reference descriptor. It can take any value conforming to the field syntax.



#### Example in a legend layer:

<p>D21*</p> <p>%TO.C,R2*%</p> <p>X5600000Y1200000D02*</p> <p>X5600000Y1202500D01*</p> <p>X5605000Y1205000D01*</p> <p>X5605000Y1220000D01*</p> <p>...</p>	<p>Select aperture 21, used for component symbols</p> <p>Select reference descriptor R2</p> <p>Move to the start of the symbol</p> <p>Draw the symbol</p>
--	---

The attribute .C,R2 is attached to all tracks drawing the resistor symbol.

On component layers the .C attribute *must* be attached to all ComponentMain flashes and all ComponentOutline draws.

## 5.6.16 . Cxxx (Component Characteristics)

These attributes can be attached to the component objects in component layers. They provide information needed for assembly.

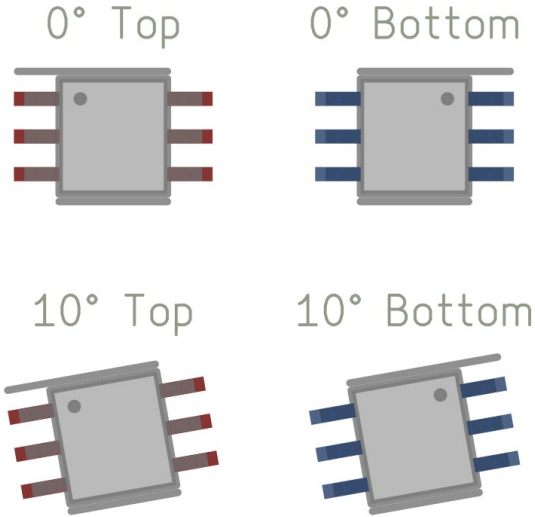
Object attributes	Usage
<p><code>.CRot, &lt;decimal&gt;</code></p>	<p>The rotation angle of the component.</p> <p>A top side component has zero-rotation orientation as in IPC-7351. Positive rotation is counterclockwise viewed from the top side of the PCB toward the bottom side.</p> <p>For bottom side you flip the unrotated component along the X axis, and then rotate to the bottom copper. Positive rotation is counterclockwise viewed from the top side of the PCB toward the bottom side.</p> <div style="text-align: center;">  </div> <p>Image courtesy Urban Bruhin.</p>
<p><code>.CMfr, &lt;field&gt;</code></p>	<p>Manufacturer</p>
<p><code>.CMPN, &lt;field&gt;</code></p>	<p>Manufacturer part number</p>
<p><code>.CVal, &lt;field&gt;</code></p>	<p>Value, e.g. 220nF</p>
<p><code>.CMnt, (TH SMD Fiducial Other)</code></p>	<p>Mount type</p>
<p><code>.CFtp, &lt;field&gt;</code></p>	<p>The name of the footprint or land pattern, being the combination of pads to mount and connect the component. Follow IPC 7351B when possible. E.g SOIC127P600X175-8.</p>
<p><code>.CPgN, &lt;field&gt;</code></p>	<p>The name of the package, being the container for a component that protect its contents and provides terminals for making connections. Use the JEDEC package designators when possible. E.g. SOIC-16-N.</p>

.CPgD, <field>	Package description
.CHgt, <decimal>	Height, in the unit of the file.
.CLbN, <field>	Name of the component library from where the component information originates
.CLbD, <field>	Description of the component library from where the component information originates
.CSup, <SN>, <SPN>, {<SN>, <SPN>}	<SN> is a field with the supplier name. <SPN> is a field with a supplier part name

All ComponentMain and ComponentOutline objects must have a .C object attribute. The <RefDes> value for each component should be unique since it links the ComponentOutline objects to their ComponentMain object. The other .Cxxx attributes are only valid for ComponentMain objects. If attached to other objects, they are ignored.

## 5.7 Text in theImage

Gerber has no native font support – this adds too much complication in relation to the modest text requirements in PCB fabrication data. Text must be represented as pure image data, best as regions (contours), see 4.10.

Font definitions often contain splines and Gerber does has linear and circular segments but no splines. The splines must therefore be approximated to either linear or circular segments. Circular is more precise with less objects than linear, but mathematically more complicated.

An issue with representing text as image is that the information is lost that this image is text, and which string it represents. This is easily solved with the attributes .AperFunction (5.6.4.1) and .FlashText (5.6.4.3). (It may be counterintuitive, but these aperture attributes can be associated with regions; see 5.3, attributes on regions.) An example; suppose one needs to add the text 'Intercept' on the bottom copper layer. Here is how it goes:

```
%TA.AperFunction,NonConductor*%    <- Indicates the copper is not a conductor,  
                                     typically text and graphics  
%TA.Flashtext,Intercept,C,M*%      <- Indicates the copper represents the string  
                                     'Intercept', as characters and mirrored  
G36*  
  
...                                  <- Draws creating the contours  
G37*  
%TD.AperFunction*%                 <- Deletes the attribute  
%TD.FlashText*%                     <- Deletes the attribute
```



## 5.8 Examples

The example below shows the usage of a simple aperture attribute.



### Example:

```
G01*
%ADD13R,200X200*%
D13*
%TAIAmATA*%
X0Y0D03*
%ADD11R,200X200*%
%TDIAmATA*%
%ADD12C,5*%
D11*
X100Y0D03*
X150Y50D02*
D12*
X100Y150D01*
```

G04 this aperture has no attribute\*

G04 add attribute IAmATA in attributes dictionary\*

G04 this flash object has no attribute\*

G04 this aperture now has attached attribute IAmATA\*

G04 delete attribute IAmATA from current attributes dictionary\*

G04 this aperture does not have attribute IAmATA\*

G04 this flash object has attribute IAmATA\*

G04 this draw object has no attribute\*

The next example illustrates an aperture attribute definition and changing value.



## Example:

```

G01*
%TA.AperFunction,SMDPad*%      G04 Adds attribute .AperFunction in the
                                current dictionary with value SMDPad to
                                identify SMD pads*

%ADD11...*%                     G04 Aperture with number 11 gets the
                                .AperFunction,SMDPad attribute attached*

%TA.AperFunction,Conductor*%    G04 Changes the value of .AperFunction
                                attribute to define conductors*

%ADD20...*%                     G04 Aperture with number 20 gets the
                                .AperFunction,Conductor attribute attached*

%TACustAttr,val*%              G04 Adds attribute CustAttr in the current
                                attributes dictionary and sets its value to
                                val*

%ADD21...*%                     G04 Aperture with number 21 is a conductor
                                with attached attribute CustAttr = val*

%TD.AperFunction*%             G04 Deletes the .AperFunction attribute from
                                the attributes dictionary*

%ADD22...*%                     G04 Aperture with number 22 has no attached
                                .AperFunction attribute, but has attribute
                                CustAttr = val*

%TDCustAttr *%                 G04 Deletes the CustAttr attribute from the
                                attributes dictionary*

%ADD23...*%                     G04 Aperture with number 23 has no attached
                                aperture attributes*

...

D11*                             G04 Set current aperture to aperture 11*
X1000Y1000D03*                  G04 Flash an SMD pad*
D20*                             G04 Use aperture 20 for graphical objects &
                                attach it to regions*

X2000Y1500D01*                  G04 Draw a conductor*
%TA.AperFunction,Conductor*%    G04 Changes the value of .AperFunction
                                attribute to define conductors*

G36*                             G04 Start a conductive region. IT TAKES ON
                                THE ATTRIBUTE VALUES FROM THE DICTIONARY*

...
G37*
%TD*%                            G04 Clear attribute dictionary*
G36*                             G04 Start a region, without attributes*

...
G37*

```

## 6 PCB Fabrication and Assembly Data

---

### 6.1 Structure

PCB Fabrication data is a set of Gerber files and possibly files in other portable formats such as PDF. The files can either be in a directory or combined in a zip file. Other archive formats such as rar, 7z are not allowed.

### 6.2 Mandatory Attributes

A single Gerber file defines a single 2D layer image. A PCB, however, is a 3D object. To define a PCB one must not only define each layer, but also where it fits in the layer structure. This is defined by the following attributes, which are mandatory in fabrication data:

- `.FileFunction`
- `.FilePolarity`
- `.SameCoordinates`

### 6.3 Alignment

All data files in a fabrication data set must align – same offset, no mirroring, seen from the top to bottom. Data must be in 1/1 scale.

### 6.4 Pads

The fabricators must be able to distinguish between pads and other copper. For example, SMD pads often have stricter tolerances than other copper, pads are the test points for electrical test, and pads must be clear of legend. To identify pads all pads must be flashed (D03), and all flashes must be pads. Pads embedded in copper pours must also be flashed, although the flash does not affect the image – its purpose is to transfer information, namely the location and shape of the pad.

### 6.5 The Profile

The profile defines the physical extent of the PCB in a machine-readable manner. The profile is represented by a contour (G36/G37) or by a cleanly connected closed path made of draws/arcs (D01) obeying the same rules as for contour segments (see 4.10.3). In case the path uses a non-zero aperture *the center line* represents the profile. A profile may contain openings of cut-outs.

A fabrication data set *must* contain a separate file with the profile. Other layers *may* contain a replica of that profile provided its aperture has the attribute `.FileFunction,Profile`

A roughly sketched outline, where lines do not connect cleanly, is not good enough. Corner marks are not good enough as they are only suitable for manual processing. Fabrication drawings can and should contain an outline drawing, but that is not a substitute for machine readable data, just as a drill map is not a substitute for drill data.

## 6.6 Drill/rout files

The image represents which material to remove. This specification does not differentiate between drilling and routing: the fabricator will determine what to drill and what to rout.

In a drill or rout file only use the circular apertures can be used, with the following constructs:

- For drill holes: flashes.
- For slots: draws and arcs; it can be a single draw/arc or a non-closed chain of draw/arcs
- For milling or cutouts (openings with a general shape): define them as openings in the profile layer, or add them as G36/G37 regions in the drill file

The drill/rout file image represents the *end diameter* of the hole; this is the diameter after plating, also known as the inner diameter. Routs are taken as is, the width of the aperture is the width. Cut-outs defined by draws where the center line defines the edge of the board do not belong to a rout file, add them to the profile layer.

Each drill span (from-to layers) must be put in a separate Gerber file. PTH and NPTH must be split in two separate files.



**Note:** In fabrication data, use Gerber rather than an NC format for drill and rout layers. It the same format as the copper layers, and mixing formats is asking for problems in registration and accuracy. Gerber supports attributes, and Gerber files are typically of far better quality. The objection is sometimes raised that a Gerber file cannot be sent to a drill machine. While this is true, it is irrelevant for fabrication data. No fabricator uses his client's incoming design files directly on his equipment, he always read them in his CAM system, and it outputs the panelized drill files in the appropriate NC format, including feeds and speeds, exactly as the drill machine needs. If for whatever reason you need to output the drill files in an NC format, then use the XNC format, which is the only one that is clearly specified and targeted to CAD to CAM data transfer.

### 6.6.1 Backdrilling

An example explains best how to structure a job with backdrilling. Suppose we have an 8 layer job with backdrilling to remove via plating between layers 8 and 7. We need two files:

One file contains the via's. It has *.FileFunction Plated,1,8,PTH*. The drill tool has the via end diameter. Its *.AperFunction* value is *Via*.

The second file contains the backdrills. It has *.FileFunction NonPlated,8,7,Blind*. The drill tool has the same diameter as the via – the manufacturer will determine the tool diameter. Its *.AperFunction* value is *Backdrill*.

## 6.6.2 Example Drill File

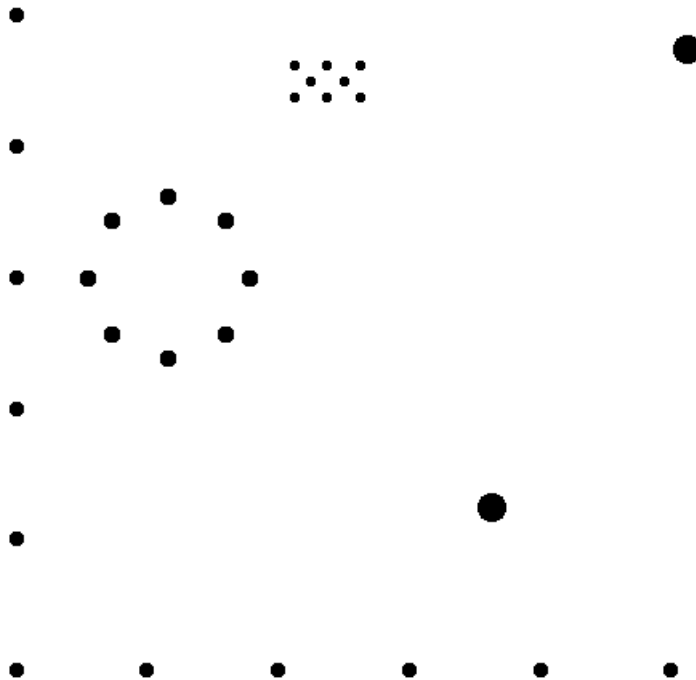

47. Example: drill file

Syntax	Annotation
<code>%FSLAX36Y36*%</code>	Format specification: Leading zero's omitted Absolute coordinates 3 integer and 6 fractional digits
<code>%MOMM*%</code>	Unit is mm
<code>%TF.FileFunction,Plated,1,8,PTH*%</code>	This file describes plated-through holes
<code>%TF.Polarity,Positive*%</code>	Always positive polarity for drill files
<code>%TF.Part,Single*%</code>	This file is part of a single PCB
<code>%TA.DrillTolerance,0.02,0.01*%</code>	Set the drill tolerance attribute to 0.02 mm in plus and 0.01 mm in minus in the attribute dictionary. It will be attached to all aperture definitions until changed or deleted
<code>%TA.AperFunction,ComponentDrill*%</code>	Attribute indicates that the following apertures define component drill holes.
<code>%ADD10C,0.14000*%</code>	Define the aperture to create holes with 0.14 mm end diameter. The AD command picks up the attributes in the attribute dictionary, which defines the as a component hole, with a 0.02 mm positive and 0.01 mm negative tolerance.

<code>%TA.AperFunction,Other,Special*%</code>	Attribute indicates that the following apertures are special drill holes
<code>%ADD11C,0.24000*%</code>	Define the aperture: a plated hole for a special purpose, with 0.24 mm end diameter with a tolerance of +0.02 mm and -0.01mm.
<code>%TA.DrillTolerance,0.15,0.15*%</code>	Changes the drill tolerance attribute for the following apertures to 0.15 mm in both directions
<code>%TA.AperFunction,MechanicalDrill*%</code>	Change the tool function attribute in the dictionary to mechanical
<code>%ADD12C,0.43000*%</code>	Define aperture 12 as a plated mechanical drill tool with 0.43 mm end diameter, and a tolerance of 0.15 mm in both directions.
<code>%ADD13C,0.22000*%</code>	Define aperture12, a tool with the same attributes but an end diameter of 0.22 mm
<code>%TD.AperFunction*%</code>	Remove the .AperFunction aperture attribute from the attributes dictionary
<code>%TD.DrillTolerance*%</code>	Remove the .DrillTolerance aperture attribute from the attributes dictionary
<code>G01*</code>	Set linear interpolation mode
<code>D10*</code>	Set aperture 10 as the current aperture.
<code>X2420000Y2750000D03*</code>	Create flash graphical objects with aperture 10: drill plated component holes with diameter 0.14 mm at the indicated coordinates
<code>Y3250000D03*</code>	
<code>X2170000Y3000000D03*</code>	
<code>X1920000Y3250000D03*</code>	
<code>X2920000Y2750000D03*</code>	
<code>X1920000D03*</code>	
<code>X2920000Y3250000D03*</code>	
<code>X2670000Y3000000D03*</code>	
<code>D11*</code>	Set the current aperture to drill tool 11
<code>X1240000Y0D03*</code>	Create flash graphical objects with aperture 11: drill plated special drill holes with diameter 0.24 mm at the indicated coordinates
<code>X0Y-1240000D03*</code>	
<code>X-1240000Y0D03*</code>	
<code>X880000Y880000D03*</code>	
<code>X-880000D03*</code>	
<code>X0Y1240000D03*</code>	
<code>X880000Y-880000D03*</code>	Set the current aperture to drill tool 12
<code>X-880000D03*</code>	
<code>D12*</code>	
<code>X7920000Y3500000D03*</code>	
<code>X4920000Y-3500000D03*</code>	Create flash graphical objects with aperture D12: drill plated mechanical drill holes with diameter 0.43 mm at the indicated coordinates

D13\*

Set the current aperture to drill tool 13

X7670000Y-6000000D03\*

Create flash graphical objects with aperture D13: drill plated mechanical drill holes with diameter 0.22 mm at the indicated coordinates

X5670000D03\*

X-2330000Y2000000D03\*

Y4000000D03\*

Y0D03\*

Y-2000000D03\*

Y-6000000D03\*

Y-4000000D03\*

X-330000Y-6000000D03\*

X1670000D03\*

X3670000D03\*

M02\*

End of file

## 6.7 Drawings and Data

Gerber files in PCB fabrication data contains two types of images.

- Drawings, such as a drill map, a fabrication drawing or an assembly drawing. Such images are intended to be looked at by humans, and may contain vital fabrication instructions.
- Digital data representing the patterns of the copper, the solder mask, legend, drills. This digital data is intended to be processed by CAM software.

Unfortunately, the two are sometimes mixed, and drawing elements added to copper files etc. as in the example below.

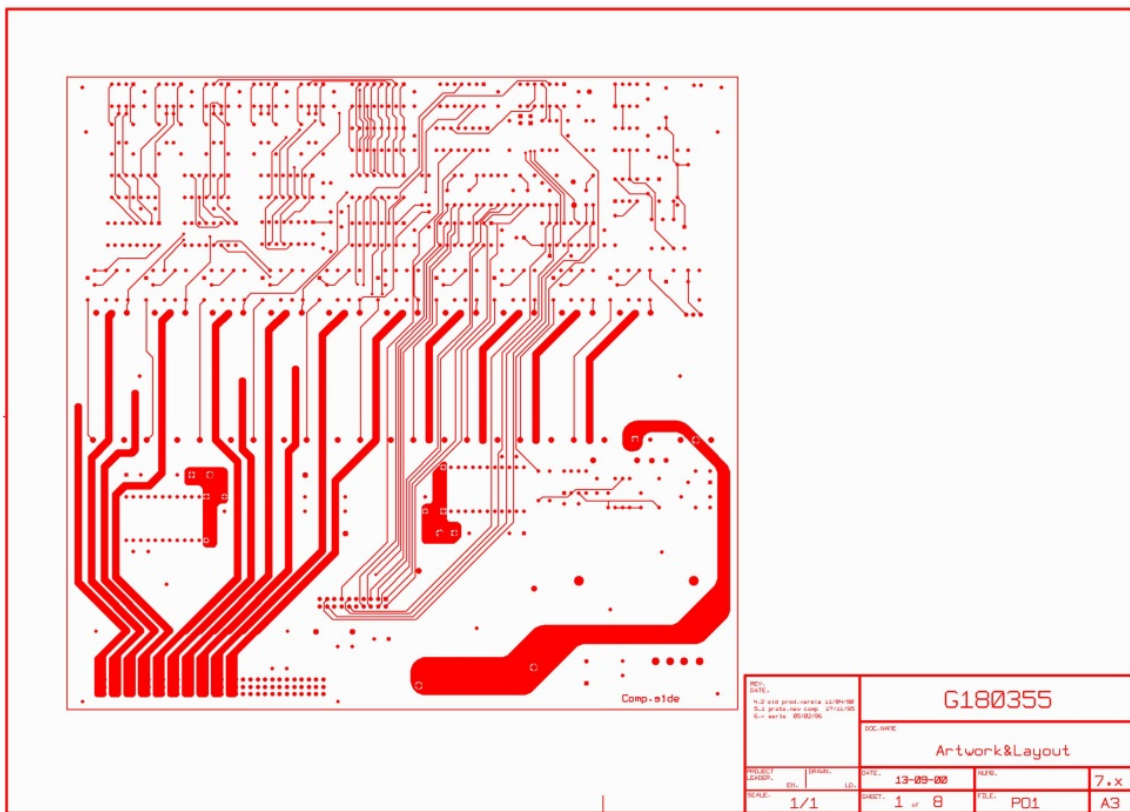

### 48. Confusing a drawing and digital data

Such a file is no longer machine readable. An operator must first manually remove the drawing elements. Before doing so he must check if these elements do not contain vital information and write this down somewhere for future reference. Keep data files pure. The drawings must contain all information that belongs to drawing. If need be, information that belongs to a specific file can be put in attributes. Less manual work, less risk of error. Simpler and cleaner.



## 6.8 The CAD Netlist

The CAD netlist describes which component pins are connected. Pins are identified by their component reference descriptor and pin number or name. Nets are identified by the net name. Here is an example of a CAD netlist; The first line lists all pins of net Clk3.

```
Clk3: U1-4,U2-3,U5-9,U6-9,U7-9
Sig11: U1-3,U5-12
Data8: U2-4,U5-10,U6-10,U7-8,U8-1
GND: U1-1,U2-1,U3-8,U4-16,U5-16,U6-1,U7-8,U8-8
...
```

The CAD netlist links component pads to nets. It specifies the function of the PCB and is the basis for the layout.

In Gerber the CAD netlist is defined by attaching both the pin and the net attribute to each component pad. This defines a pad – net entry in the CAD netlist, and at the same time associates a pad location and shape to it. For instance, the first entry in the CAD netlist above is given by the following sequence:

```
%TO.P,U1,4*%
%TO.N,Clk3*%
X...Y...D03*      The flash that creates the pad
...
```

It is recommended to add .P attribute to all electrical end points, not only physical component leads but edge connectors and test points. Although vias are part of a net, they are not component pads and cannot have a .P attached. Washer pads or any pads that are not part of a component cannot have a .P attached.

### 6.8.1 Benefits of Including the CAD Netlist.

For the assembly process the location and orientation of each component must be known. This can easily be extracted from the Gerber file.

The netlist and component names facilitate the communication between the parties involved in design and fabrication. Viewers show more complete PCB information.

More importantly, the netlist information dramatically increases the security of the design to fabrication data transfer. If the image CAM reads from a Gerber file significantly differs from the image intended by CAD, due to bugs, operator errors or transmission errors, the inevitable result is scrap. Such a difference in image results in a difference in board netlist, which can be detected by comparing the calculated board netlist with the supplied CAD netlist. The CAD netlist therefore provides a very powerful redundancy check against image errors. To be precise, the following assert must be valid:

- Interpret all N/C's as unique names
- Flashes with the same reference descriptor and pad are deemed connected
- Etched components are removed before connection is calculated
- Assert 1: pads with the same net name must be connected
- Assert 2: pads with different net names must be isolated.

Lastly, a bare board PCB fabricator is expected to perform an electrical test on the bare PCB and guarantee the PCB conforms to the CAD netlist. It then is logical to provide him with the netlist to test against. Without providing the netlist the fabricator is expected to reverse engineer the netlist and must test against a reverse engineered net – hardly a secure procedure.

## 6.8.2 IP Considerations

Net names such as Clk13 provide information about the design. This may be a concern. A solution is to replace the meaningful names with obfuscated names such as a sequential number. This still allows to compare the design netlist with the image netlist as a redundancy check – meaningful names are not needed for that. The obfuscated names are a little less convenient when communicating between creator and receiver of the Gerber file, but both can still identify the same net as long as the creator can identify the net corresponding to the obfuscated name he created. Obfuscated names are sometimes a sensible balance between IP protection and data transfer security.

It is sometimes alleged that even a net list with obfuscated names pose an IP security risk as it still shows the connections between the pads. This is an obvious fallacy as the connections between the pads can be worked out from the image. In fact, if this were not true, a fabricator would be unable to perform a bare board electrical test without netlist information.

## 6.9 PCB Assembly Data

### 6.9.1 Overview

The purpose of the component layers in Gerber data is to transfer from CAD to manufacturing the component information it needs. It allows to

- visualize the component placement to check for errors and set up the assembly,
- generate the manufacturing tools, such as the paste stencils and the pick and place machine programs,
- assist in the procurement of the components.

The intended workflow is that the CAD Gerber output data is read into an assembly CAM system, which analyzes the incoming data, allows for visual inspection and generates the outputs tuned to the specific assembly equipment.

Component information is all too often transferred as separate, non-standardized drawings, pick & place and BOM files. The component layers transfer this information in a standardized, unequivocal and machine-readable manner. Component location is geometrical data: the centroid, outline, fiducial locations and the footprints; geometric data naturally fits in a Gerber layer. Combining bare board and component data in Gerber files allows a holistic review of the final board.

Component information was added in revision 2020.09, also called X3. The components information is naturally included by adding two new Gerber files: the top and bottom component file. By placing new the component data in separate files, full compatibility is maintained: if one does not like the component files, simply ignore them. The new standard is therefore compatible with existing workflows. Legacy software handles the CAD data with the new assembly information without change, of course also without benefiting from it. Great care is taken to minimize the development effort by keeping the existing fabrication outputs in place and sticking to an existing syntax. Benefits:

- Compatible with installed base
- Minimal implementation work.
- Any decent legacy viewer displays the new component layers.

### 6.9.2 Assembly Data Set

To transfer component information one can simply add component layers to the full bare board fabrication data set. If there are concerns about the confidentiality of the design one can omit the inner layers as they are not needed for assembly; the data does then not implicitly contain the netlist. As an example, a typical data set for a four-layer board is:

```
%TF.FileFunction,Component,L1,Top*%  
%TF.FileFunction,Legend,Top*%  
%TF.FileFunction,Soldermask,Top*%  
%TF.FileFunction,Copper,L1,Top*%  
%TF.FileFunction,Copper,L4,Bot*%  
%TF.FileFunction,Soldermask,Bot*%  
%TF.FileFunction,Legend,Bot*%  
%TF.FileFunction,Component,L4,Bot*%  
%TF.FileFunction,Plated,1,4,PTH*%  
%TF.FileFunction,NonPlated,1,4,NPTH*% (If there are NPTH.)
```

The top and bottom component layers specify component information needed for the assembly process. A set of attributes identify each component's location, orientation, identification, and its properties such as manufacturer part number. The outer copper layers, mask, legend and drill

layers serve to verify component placement and provide registration information for pick-and-place machines. An assembly drawing can contain useful information that is not in the component layers.

The pin locations are included in the component layer to unequivocally specify location and rotation of the components, with the aperture function ComponentPin and .P attribute. The .P attribute is mandatory for each ComponentPin flash. Any .Cxxx attributes attached to a pin are ignored.

The component layer can include fiducials. If they are added a zero-size aperture must be used, with .AperFunction value the existing value FiducialPad,Local, and object attribute .C to identify the component.

See the Component Layers section of the table in 5.6.10, as well as 5.6.14, 5.6.15 and 5.6.16 for more information on specifying components.

### 6.9.3 Annotated Example Component Layer

Commands	Annotation
<pre>%TF.GenerationSoftware,KiCad,Pcbnew,(5.99.0-190-g0fd48dd4f-dirty)*% %TF.CreationDate,2019-10-02T18:52:55+02:00*% %TF.ProjectId,kit-dev-coldfire-xilinx_5213,6b69742d-6465-4762-9d63-6f6c64666972,2*% %TF.SameCoordinates,PX3e22018PY8d89728*% %TF.FileFunction,Component,L1,Top*%</pre>	<p><b>This file is the top component layer</b></p>
<pre>%TF.FilePolarity,Positive*% %FSLAX46Y46*% %MOMM*% %LPD*%</pre>	
<pre>G04 Aperture begin list* %TA.AperFunction,ComponentMain*% %ADD10C,0.3*%</pre>	<p><b>The aperture for the flash with the main component information</b></p>
<pre>%TA.AperFunction,ComponentOutline,Courtyard*% %ADD11C,0.1*%</pre>	<p><b>The aperture to draw the outline</b></p>
<pre>%TA.AperFunction,ComponentPin*% %ADD12P,0.36X4X0.0*%</pre>	<p><b>The aperture to flash the pin 1 location</b></p>
<pre>%ADD13C,0*%</pre>	<p><b>The aperture for the other pin locations</b></p>
<pre>%TD*% G04 Aperture end list* G04 Begin component info*</pre>	

Commands	Annotation
D10*	Select main component aperture
%TO.C,R301*%	Attach reference descriptor R301
%TO.CFtp,R_0805_2012Metric*%	Attach footprint
%TO.CVal,4K7*%	Attach value
%TO.CMnt,SMD*%	Attach mount type
%TO.CRot,-90*%	Attach rotation
X218250000Y-73000000D03*	Flash at reference point
D11*	Select outline aperture
X219250000Y-71310000D02*	Draw outline
X217250000Y-71310000D01*	Draw outline
X217250000Y-74690000D01*	Draw outline
X219250000Y-74690000D01*	Draw outline
X219250000Y-71310000D01*	Draw outline
D12*	Select key pin aperture
%TO.P,R301,1*%	Attach ref. desc and pin number
X218250000Y-72045000D03*	Flash at key pin location
D13*	Select subsequent pin aperture
%TO.P,R301,2*%	Attach pin 2 ident
X218250000Y-73955000D03*	Flash at key pin location
%TD*%	Clear attributes before next component
G04 Next component*	
...	

# 7 Errors and Bad Practices

## 7.1 Errors

Poor implementation of the Gerber format can give rise to invalid Gerber files or – worse – valid Gerber files that do not represent the intended image. The table below lists the most common errors.

Symptom	Cause and Correct Usage
Standard Gerber or RS-274-D	Standard Gerber is revoked and is therefore <i>no longer valid</i> Gerber. It was designed for a workflow that is as obsolete as the mechanical typewriter. It requires manual interpretation and is therefore error-prone. Do not use it. See 8.5. <b>Always use Gerber X!</b>
Clearances in planes disappear.	This is often the consequence of invalid cut-ins resulting in self-intersecting contours. The root cause is usually sloppy rounding aggravated by low-resolution output. Use 6 digits precision. <i>See 4.10.3.</i>
Rotating aperture macros using primitive 21 gives unexpected results.	Some CAD systems incorrectly assume that primitive 21 rotates around its center. This is wrong, it rotates around the origin. <i>See 4.5.1.5.</i>
Unexpected image after an aperture change or a D03.	Coordinates have been used without an explicit D01/D02/D03 operation code. This practice is deprecated because it leads to confusion about which operation code to use. <b>Coordinate data must always be combined with an explicit D01/D02/D03 operation code.</b> <i>See 8.1.10.</i>
Objects unexpectedly appear or disappear under holes in standard apertures.	Some CAD systems incorrectly assume the hole in an aperture <i>clears</i> the underlying image. This is not so, the hole has <i>no effect</i> on the underlying image. <i>See 4.4.6.</i>
Objects unexpectedly appear or disappear under holes in macro apertures.	Some systems incorrectly assume that exposure off in a macro aperture <i>clears</i> the underlying objects under the flash. This is wrong, exposure off creates a hole in the aperture and that hole has no effect on the image. <i>See 4.5.1.</i>

Polygons are smaller than expected.	Some CAD systems incorrectly assume the parameter of a Regular Polygon specifies the inside diameter. This is wrong: it specifies the outside diameter. <i>See 4.4.5.</i>
The result of the MI command is not as expected.	The MI command mirrors coordinate data but not apertures. A number of implementations unfortunately also mirror apertures making MI unsafe to use. It is therefore deprecated. Do not use the MI command but apply the transformation directly in the coordinate data. <i>See 8.1.7.</i>
The result of the SF command is not as expected.	The SF command scales coordinate data but no other sizes in the file. A number of implementations unfortunately also scale other elements making SF unsafe to use. It is therefore deprecated. Do not use the SF command but apply the transformation directly in the coordinate data. <i>See 8.1.9</i>
A single Gerber file contains more than one image, separated by M00, M01 or M02	This is invalid. A Gerber file can contain only one image. One file, one image. One image, one file.
Sending a PCB layer as several positive/negative files that must be merged together.	This is <i>invalid</i> in Gerber X. See 2.1. (It was valid in Standard Gerber but became obsolete with the introduction of LPD/LPC in Gerber X.) Apart from being invalid this obnoxious practice requires manual work and is error prone. One wonders why someone in his right mind would use this archaic method, which has a serious risk of scrap. <b>One file = one layer</b>
Strange error message.	Some files contain the strange pseudo command %ICAS*%. One wonders what this is supposed to achieve. Anyhow, it is invalid.
Error message; not the intended image.	Invalid format specification %FSD....*% The only valid zero omission options in the %FS are L and T. D is invalid. See 8.2.1.1.
Strange error message.	*Presence of %FSLAN2X26Y26*% The N2 in the format specification is invalid. See 4.1 One wonders what it is supposed to do.
Strange error message.	...X5555Y5555IJ001 Missing zero after the "I". The number after I must have at least one digit, see 13.5

### Reported errors

## 7.2 Bad Practices

Some Gerber files are syntactically correct but are needlessly cumbersome or error-prone. The table below summarizes common poor practices and gives the corresponding good practice.

Bad Practice	Problems	Good Practice
PCB fabrication data sets without proper profile layer.	The profile is an essential part of the fabrication data. It must be accurately defined, in a machine-readable manner. All too often only a drawing is provided, or corner marks, or the profile is only present merged in copper layers etc.	<b>Always include a profile layer with a clean, accurately constructed profile. See 6.5</b>
Painted copper pours (aka stroking or vector-fill)	Painted copper pours produce the intended image, but the file size explodes and getting rid of the painting require time consuming and error-prone manual work by CAM operators. Painting was needed for vector photoplotters in the 1960s and 1970s, devices now as outdated as the mechanical typewriter. There is not a single reason left to use painting.	<b>Always define copper pours with contours (G36/G37)</b>
Painted pads (aka stroking or vector-fill)	See painted copper pours above. Painting is even more damaging for pads, as the fabricator needs to know where the pads are, for example for electrical test. The only practical way to identify pads is to use flashes for pads exclusively.	<b>Always use flashed pads.</b> Define pads, including SMD pads, with the AD and AM commands.
PCB fabrication data sets without netlist.	PCB fabrication data is complex geometric data with an infinite number of variations. Differences in the interpretation of image data is very rare but does happen and then is costly. A netlist is a powerful check on the image data – it is akin to the redundancy checks used in all data transfer protocols. Omitting a netlist is omitting a basic security check.	<b>Always include a netlist in a PCB fabrication data set. A netlist can be provided in IPC-D-356A file or with Gerber attributes – see 6.8.</b>



<p>Low resolution (numerical precision)</p>	<p>Poor registration of objects between PCB layers; loss of accuracy; self-intersecting contours; invalid arcs; turning small arcs into full circles, missing clearances. Poor numerical accuracy is the main cause for errors in geometric software. Low resolution is the root cause for most problems with Gerber files and sometimes leads to scrap.</p> <p>Why would one use low resolution? To save a few bytes? It is sometimes argued some Gerber readers can only handle low resolutions. This may have been true in a distant past but it no longer is true now. And anyhow, ask yourself, will you risk scrap to cater for a few antiquated implementations?</p>	<p><b>Use 6 decimals in mm units.</b> See 4.1 and 8.2.1.</p>
<p>Cutting a single copper pour in pieces, typically through the clearances to avoid regions with holes.</p>	<p>The information what the copper pour is and where the clearances are is lost in a tangle of data, made worse by rounding error. The reader must attempt to laboriously reverse engineer the copper pour and clearances. Risk of scrap.</p>	<p><b>See section 4.10.5.</b></p>
<p>Imprecisely positioned arc center points</p>	<p>An imprecisely positioned center makes the arc ambiguous and open to interpretation. This can lead to unexpected results.</p> <p>See 4.7.2</p>	<p><b>Always position arc center points precisely.</b></p>
<p>Pads as contours instead of flashes</p>	<p>See above.</p>	<p><b>Always use flashed pads.</b> Define pads, including SMD pads, with the AD and AM commands.</p>
<p>Non-standard file extensions</p>	<p>When you use a non-standard file extension the reader must open the file to know what format it is and which application to use.</p> <p>See 3.5.</p>	<p><b>Please use “.gbr” or “.GBR” as file extension for all your Gerber files.</b></p>
<p>Writing files with deprecated constructs.</p>	<p>Each construct was deprecated for a reason. Many carry the risk of a misinterpretation. Continuing to use deprecated constructs is bad corporate citizenship as it blocks the industry from taking the next steps.</p>	<p><b>Generate files with current constructs only.</b> (Note: it is OK for readers to handle deprecated constructs to cater for legacy files.)</p>

*Bad/good practices*

# 8 Deprecated Format Elements

## 8.1 Deprecated Commands

### 8.1.1 Overview

Current Gerber writers must not use the deprecated commands. Gerber readers may implement them to support legacy applications and files. The next table lists deprecated commands.

Code	Function	Comments
G54	Select aperture	This historic code optionally precedes an aperture selection Dnn command. It has no effect. Sometimes used. Deprecated in 2012.
G55	Prepare for flash	This historic code optionally precedes D03 code. It has no effect. Very rarely used nowadays. Deprecated in 2012.
G70	Set the 'Unit' to inch	These historic codes perform a function handled by the MO command. See 4.2.1. Sometimes used. Deprecated in 2012
G71	Set the 'Unit' to mm	
G90	Set the 'Coordinate format' to 'Absolute notation'	These historic codes perform a function handled by the FS command. See 4.1. Very rarely used nowadays. Deprecated in 2012.
G91	Set the 'Coordinate format' to 'Incremental notation'	
M00	Program stop	This historic code has the same effect as M02. See 4.13. Very rarely, if ever, used nowadays. Deprecated in 2012.
M01	Optional stop	This historic code has no effect. Very rarely, if ever, used nowadays. Deprecated in 2012.
IP	Sets the 'Image polarity' graphics state parameter	This command has no effect in CAD to CAM workflows. Sometimes used, and then usually as %IPPOS*% to confirm the default and then it then has no effect. <i>As it is not clear how %IPNEG*% must be handled it is probably a waste of time to try to fully implement it, and sufficient to give a warning on a %IPNEG*% and skip it.</i> Deprecated in 2013
AS	Sets the 'Axes correspondence' graphics state parameter	Deprecated in 2013. Rarely, if ever, used nowadays. If used it was nearly always, if not always, to confirm the default value and then these commands have no effect.
IR	Sets 'Image rotation' graphics state parameter	

MI	Sets 'Image mirroring' graphics state parameter	It is a waste of time to fully implement these commands. The simplest is simply to ignore these commands. Theoretically safer is to skip them if they confirm the default and throw an error on any other use; chances are you will never see the error.
OF	Sets 'Image offset' graphics state parameter	
SF	Sets 'Scale factor' graphics state parameter	
IN	Sets the name of the file image. Has no effect. It is comment.	This is just a comment. Use G04 for comments. See 4.1. Ignore it. Sometimes used. Deprecated in 2013.
LN	Loads a name. Has no effect. It is a comment.	This is just a comment. Use G04 for comments. See 4.1. Ignore it. Sometimes used. Deprecated in 2013.
G74	Sets single quadrant mode	Rarely used, and then usually to confirm a default, but without practical effect. Sometimes used. Deprecated in 2020.

### *Deprecated Gerber Commands*

#### 8.1.2 Axis Select (AS)

The AS command is deprecated since revision I1 from December 2012.

The historic AS command sets the correspondence between the X, Y data axes and the A, B output device axes. It does not affect the image in computer to computer data exchange. It only has an effect how the image is positioned on an output device.

The order of execution is always MI, SF, OF, IR and AS, independent of their order of appearance in the file.

The AS command can only be used once, at the beginning of the file.

##### 8.1.2.1 AS Command

The syntax for the AS command is:

**AS = '% (AS' ('AXBY'|'AYBX')) '\*%';**

Syntax	Comments
AS	AS for Axis Select
AXBY	Assign output device axis A to data axis X, output device axis B to data axis Y. This is the default.
AYBX	Assign output device axis A to data axis Y, output device axis B to data axis X.

##### 8.1.2.2 Examples

Syntax	Comments
--------	----------

%ASAXBY*%	Assign output device axis A to data axis X and output device axis B to data axis Y
%ASAYBX*%	Assign output device axis A to data axis Y and output device axis B to data axis X

### 8.1.3 Image Name (IN)

The IP command is deprecated since revision I4 from October 2013.

The historic IN command gives a name to the image contained in the Gerber file. The name must comply with the syntax rules for a string as described in section 3.4.3. This command can only be used once, at the beginning of the file.

IN has *no* effect on the image. A reader can ignore this command.

The informal information provide by IN can also be put a G04 comment.

#### 8.1.3.1 IN Command

The syntax for the IN command is:

**IN = '%' ('IN' name) '\*%';**

Syntax	Comments
IN	IN for Image Name
<Name>	Image name

#### 8.1.3.2 Examples

Syntax	Comments
%INPANEL_1*%	Image name is 'PANEL_1'

### 8.1.4 Image Polarity (IP)

The IP command is deprecated since revision I4 from October 2013.

IP sets positive or negative polarity for the entire image. It can only be used once, at the beginning of the file.

#### 8.1.4.1 Positive Image Polarity

Under *positive* image polarity, the image is generated as specified elsewhere in this document. (In other words, the image generation has been assuming positive image polarity.)

#### 8.1.4.2 Negative Image Polarity

The purpose of negative image polarity is to create a negative image, clear areas in a dark background. The entire image plane in the background is initially dark instead of clear. The effect of dark and clear polarity is toggled. The entire image is simply reversed, dark becomes white and vice versa.

In negative image polarity, the first graphical object encountered *must* have dark polarity.

### 8.1.4.3 IP Command

The syntax for the IP command is:

**IP = '%' ('IP' ('POS'|'NEG')) '\*\*%';**

Syntax	Comments
IP	IP for Image Polarity
POS	Image has positive polarity
NEG	Image has negative polarity

### 8.1.4.4 Examples

Syntax	Comments
%IPPOS*%	Image has positive polarity
%IPNEG*%	Image has negative polarity

### 8.1.5 Image Rotation (IR)

The IR command is deprecated since revision I1 from December 2012.

IR rotates the entire image counterclockwise in increments of 90° around the image origin (0, 0). All image objects are rotated. The IR command affects the entire image. It must be used only once, at the beginning of the file. The order of execution is always MI, SF, OF, IR and AS, independent of their order of appearance in the file.

#### 8.1.5.1 IR Command

The syntax for the IR command is:

**IR = '%' ('IR' ('0'|'90'|'180'|'270')) '\*\*%';**

Syntax	Comments
IR	IR for Image Rotation
0	Image rotation is 0° counterclockwise (no rotation)
90	Image rotation is 90° counterclockwise
180	Image rotation is 180° counterclockwise
270	Image rotation is 270° counterclockwise

#### 8.1.5.2 Examples

Syntax	Comments
%IR0*%	No rotation
%IR90*%	Image rotation is 90° counterclockwise

%IR270*%	Image rotation is 270° counterclockwise
----------	---

## 8.1.6 Load Name (LN)

The IP command is deprecated since revision I4 from October 2013.

This historic command has *no* effect on the image and can be ignored.

LN assigns a name to the subsequent part of the file. It was intended as a human-readable comment. Use the normal G04 command for human-readable comment. The LN command can be used multiple times in a file.

### 8.1.6.1 LN Command

The syntax for the LN command is:

**LN = '%' ('LN' name) '\*%';**

Syntax	Comments
LN	LN for Load Name
<Name>	The name must comply with the syntax for a string, see section 3.4.3.

### 8.1.6.2 Examples

Syntax	Comments
%LNVia_anti-pads*%	The name 'Via_anti-pads' is to the subsequent file section

## 8.1.7 Mirror Image (MI)

The MI command is deprecated since revision I1 from December 2012.

MI sets the mirroring for the coordinate data. All the *coordinate data* – and *only* coordinate data - are mirrored according to the specified factor. **Step and repeat distances are not coordinate data – see 4.9 - and hence are *not* mirrored. Apertures are *not* mirrored.**

This command affects the entire image. It can only be used once, at the beginning of the file. The default is no mirroring. The order of execution is always MI, SF, OF, IR and AS, independent of their order of appearance in the file.



Quite a number of implementations incorrectly also mirror apertures and/or step and repeat distances. These incorrect implementations make the MI too risky to use. We strongly recommend *not* to use MI on output as you do know how the reader will interpret the file. If an image must be mirrored, write out the mirrored coordinates and apertures.

### 8.1.7.1 MI Command

The syntax for the MI command is:

**MI = '%' (['A'('0'|'1')]['B'('0'|'1')]) '\*%';**

Syntax	Comments
--------	----------

MI	MI for Mirror image
A(0 1)	Controls mirroring of the A-axis data: A0 – disables mirroring A1 – enables mirroring (the image will be flipped over the B-axis) If the A part is missing, then mirroring is disabled for the A-axis data
B(0 1)	Controls mirroring of the B-axis data: B0 – disables mirroring B1 – enables mirroring (the image will be flipped over the A-axis) If the B part is missing, then mirroring is disabled for the B-axis data

### 8.1.7.2 Examples

Syntax	Comments
%MIA0B0*%	No mirroring of A- or B-axis data
%MIA0B1*%	No mirroring of A-axis data Mirror B-axis data
%MIB1*%	No mirroring of A-axis data Mirror B-axis data

### 8.1.8 Offset (OF)

The OF command is deprecated since revision I1 from December 2012.

OF moves the final image up to plus or minus 99999.99999 units from the imaging device (0, 0) point. The image can be moved along the imaging device A or B axis, or both. The offset values used by OF command are absolute. If the A or B part is missing, the corresponding offset is 0. The offset values are expressed in units specified by MO command. This command affects the entire image. It can only be used once, at the beginning of the file. The order of execution is always MI, SF, OF, IR and AS, independent of their order of appearance in the file.

#### 8.1.8.1 OF Command

The syntax for the OF command is:

**OF = '%' (['A' decimal]['B' decimal]) '\*%';**

Syntax	Comments
OF	OF for Offset
A<Offset>	Defines the offset along the output device A axis
B<Offset>	Defines the offset along the output device B axis

The **<Offset>** value is a decimal number n preceded by the optional sign ('+' or '-') with the following limitation:

$0 \leq n \leq 99999.99999$

The decimal part of n consists of not more than 5 digits.

### 8.1.8.2 Examples

Syntax	Comments
%OFA0B0*%	No offset
%OFA1.0B-1.5*%	Defines the offset: 1 unit along the A axis, -1.5 units along the B axis
%OFB5.0*%	Defines the offset: 0 units (i.e. no offset) along the A axis, 5 units along the B axis

### 8.1.9 Scale Factor (SF)

The SF command is deprecated since revision I1 from December 2012.

SF sets a scale factor for the A- and/or B-axis coordinate data. All the *coordinate data* – and *only* coordinate data - are multiplied by the specified factor for the corresponding axis. **Step and repeat distances – see 4.9 - are not coordinate data and hence are not scaled. Apertures are not scaled.**

This command affects the entire image. It can only be used once, at the beginning of the file. The default scale factor is '1'. The factor values must be between 0.0001 and 999.99999. The scale factor can be different for A and B axes. The order of execution is always MI, SF, OF, IR and AS, independent of their order of appearance in the file.



Quite some legacy readers incorrectly also scale step and repeat distances. You cannot know how the reader will interpret the data and that make the SF too risky to use. Many readers simply do not support it. *Do not to use SF.* If an image must be scaled, write out the scaled coordinates.

#### 8.1.9.1 SF Command

The syntax for the SF command is:

**SF = '%' ('SF' ['A' decimal]['B' decimal]) '\*%';**

Syntax	Comments
SF	SF for Scale Factor
A decimal	The scale factor for the A-axis data.
B decimal	The scale factor for the B-axis data.

The scale factor is an unsigned decimal number n where  $0.0001 \leq n \leq 999.99999$ .

### 8.1.9.2 Examples

Syntax	Comments
--------	----------



%SFA1B1*%	Scale factor 1. A decimal.
%SFA.5B3*%	Defines the scale factor: 0.5 for the A-axis, 3 for B. Decimals.

## 8.1.10 Single-quadrant arc mode (G74)

Historically, there were two arc quadrant modes:

- ❑ Single quadrant mode, set by G74 command
- ❑ Multi quadrant mode, set by G75 command

The single-quadrant mode G74 was deprecated in 2021. Already in 2020 it occurred in <1/1000 files. In the vast majority its presence had no effect: a G75 set multi-quadrant mode before any arc was effectively constructed. Implementors of Gerber input software that wish to support legacy files will get a very long way without fully implementing G74 mode but give an error when an attempt is made to create an arc in G74 – this error will exceedingly rarely occur.

Quadrant mode	Comments
Single quadrant (G74) Deprecated	In single quadrant mode the arc is not allowed to extend over more than 90°. The following relation must hold: $0^\circ \leq A \leq 90^\circ$ , where A is the arc angle  If the start point of the arc is equal to the end point, the arc has length zero, i.e. it covers 0°. A separate operation is required for each quadrant. A minimum of four operations is required for a full circle.
Multi quadrant (G75) Current	In multi quadrant mode the arc is allowed to extend over more than 90°. To avoid ambiguity between 0° and 360° arcs the following relation must hold: $0^\circ < A \leq 360^\circ$ , where A is the arc angle  If the start point of the arc is equal to the end point, the arc is a full circle of 360°.

### *Quadrant modes*

The syntax of the G74 commands is:

**G74 = :('G74') '\*\*;**



**Example:**

G74\*

The syntax of the D01 command in single quadrant circular interpolation mode is:

**D01 = ([ 'X' x\_coordinate ] [ 'Y' y\_coordinate ] 'I' x\_distance 'J' Y\_distance ) 'D01' '\*\*;**

Syntax	Comments
X x_coordinate	X_coordinate defines the X coordinate of the end point of the arc. It is of the coordinate data type. The default is the X coordinate of the current point.
Y y_coordinate	As above, but for the Y axis.
I x_distance	The x_distance defines the distance between the arc start point and the center parallel to the X axis. Distance is $\geq 0$ . It is of the coordinate data type.
J<Distance>>	As above, but for the Y axis.

Syntax	Comments
D01	Interpolate operation code

### 49. Circular interpolation example

In single quadrant mode, awkwardly, *the sign of the offsets is omitted*, converting them to unsigned distances. There are four candidates for the center: (<Current X> +/- <X distance>, <Current Y> +/- <Y distance>). The center is the candidate that results in an arc with the specified orientation, not greater than 90° and with the least deviation. The reason for this oddity is purely historic, from a very distant past.

 **Example:**

Syntax	Comments
G74*	Set single quadrant mode
D10*	Select aperture 10 as current aperture
X1100Y600D02*	Set the current point to (11, 6)
G03*	Set counterclockwise interpolation mode
X700Y1000I400J0D01*	Create quarter arc object (radius 4) to (7, 10)
X300Y600I0J400D01*	Create quarter arc object (radius 4) to (3, 6)
X700Y200I400J0D01*	Create quarter arc object (radius 4) to (7, 2)
X1100Y600I0J400D01*	Create quarter arc object (radius 4) to (11, 6)
X300D02*	Create quarter arc object (radius 4) to (3, 6)
G01*	Set the current point to (3, 6)
X1100D01*	Set linear interpolation mode
X700Y200D02*	Create draw object to (11, 6)
Y1000D01*	Set the current point to (7, 2)
	Create draw object to (7, 10)

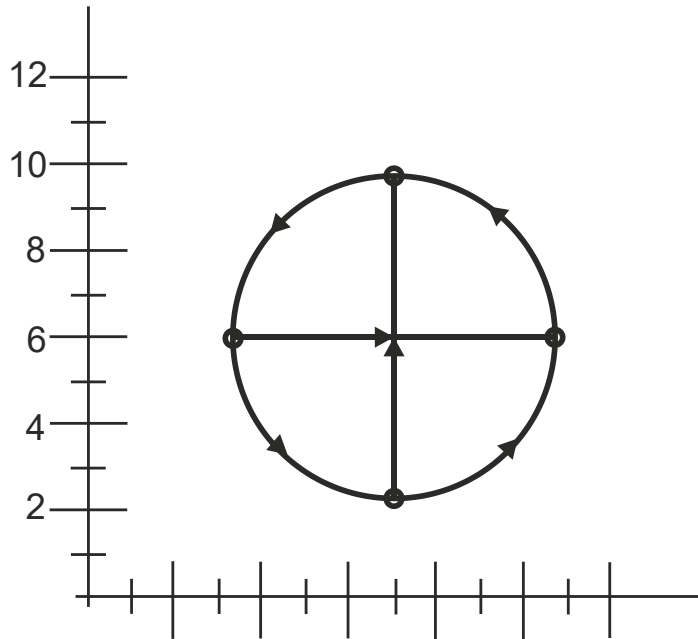

50. Single quadrant mode example: arcs and draws

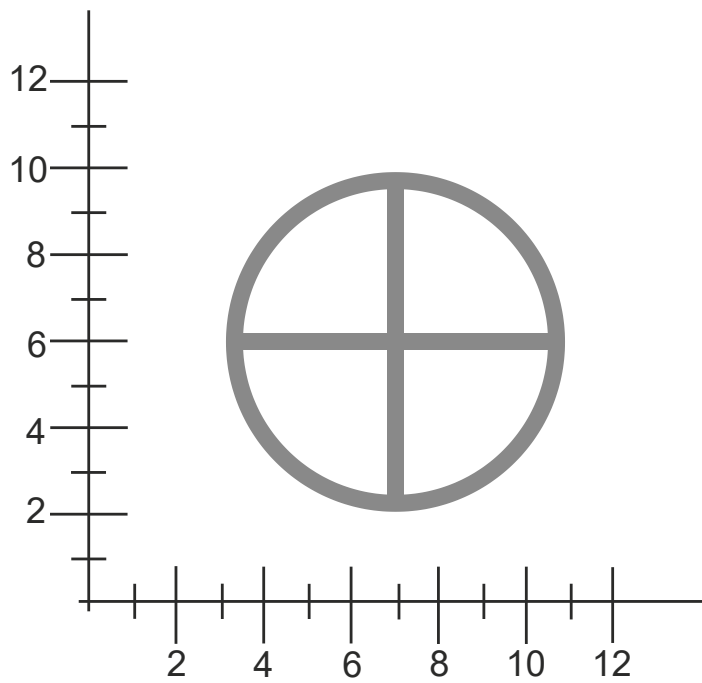

51. Single quadrant mode example: resulting image

In important difference between G74 and G75 arcs is what happens when start point and end point coincide. For G75 this represents a full 360° arc, in G75 a zero-degree arc. Some examples.

Syntax	Comments
D10*	Select aperture 10 as current aperture
G01*	Set linear interpolation mode
X0Y600D02*	Set the current point to (0, 6)
<b>G74*</b>	Set single quadrant mode
G02*	Set clockwise circular interpolation mode
X0Y600I500J0D01*	Create arc object to (0, 6) with radius 5

The resulting image is small dot, an instance of the aperture, at position (0, 6)

Syntax	Comments
D10*	Select aperture 10 as current aperture
G01*	Set linear interpolation mode
X0Y600D02*	Set the current point to (0, 6)
<b>G75*</b>	Multi quadrant mode
G02*	Set clockwise circular interpolation mode
X0Y600I500J0D01*	Create arc object to (0, 6) with center (5,6)

The resulting image is a full circle.

## 8.2 Deprecated Command Options

### 8.2.1 Format Specification (FS) Options

This section describes deprecated options of the FS command (see 4.1).

The FS command could also be used to specify the following format characteristics:

- Trailing zero omission
- Incremental coordinate notation
- Low resolution (less than 6 decimals in inch units and less than 5 in mm units).

#### 8.2.1.1 Trailing Zero Omission

Trailing zero omission is deprecated since revision 2015.06.

*Trailing zero omission* some or all trailing zero's can be omitted but all leading zero's are required. To interpret the coordinate string, it is first padded with zero's at the back until its length fits the coordinate format. For example, with the "23" coordinate format, "15" is padded to "15000" and therefore represents 15.000.

The coordinate data must contain at least one digit. Zero therefore should be encoded as "0".

Trailing zero omission is specified by 'T' after the FS code. (The normal leading zero omission is specified by 'L' after the FS code.)



**Example:**

```
%FSTAX25Y25*%
```

Trailing zero omission is rarely found in legacy files. Gerber readers will go a long way without supporting it.

#### 8.2.1.2 Incremental Notation

Incremental notation is deprecated since revision I1 from December 2012.

Incremental notation means that coordinate values are as the incremental distances from the previous coordinate position. It is specified by the "I" in the FS command, after the "L" or "T" for leading or trailing. (The normal absolute notation is specified by 'A' in the FS command.)



**Example:**

```
%FSLIX25Y25*%
```

```
%FSTIX36Y36*%
```

Incremental notation was sometimes used as a simplistic compression when saving a few bytes was a fantastic advantage, and before the invention of Lempel–Ziv–Welch (LZW) and other *lossless* compression methods. The problem is that the accumulation of rounding errors leads to significant loss of precision. This results in poor registration, invalid arcs, self-intersecting contours, often resulting in scrap. Avoid incremental notation like the plague.

Incremental notation is fortunately but rarely used in legacy files. Gerber readers will go a long way without supporting it.

### 8.2.1.3 Low resolution

Low resolution, this is using less than 6 decimals in inch units and less than 5 decimals in mm units is deprecated since revision 2015.06.

Low resolution was introduced in the 1960's as a simplistic compression method when saving a few bytes was of paramount importance, and computers were too feeble for proper *lossless* compression methods such as Lempel–Ziv–Welch (LZW).

Low resolution loses numerical precision and poor numerical precision is the main cause of bugs in geometric software. It leads to poor registration of objects between PCB layers; loss of accuracy; self-intersecting contours; invalid arcs; small arcs turning in full circles, missing clearances. Low resolution is the main cause of problems with Gerber files, sometimes leading to scrap.

Unfortunately, low resolution files are still quite common. There are even files in inch with 3 decimals, or a resolution of 1 mil; this is asking for problems.

It is sometimes recommended to use low resolution because some Gerber readers allegedly only handle low resolutions. Do not listen. This may have been true in a distant past, but it no longer true, if it ever was. Ask yourself: does it make sense to risk scrap to save a few bytes or to cater for a few rumored stone-age implementations? The days that saving a few bytes was important are long gone. The risks of low resolution remain. Avoid low resolution like the plague.

Low resolution files are unfortunately quite common in legacy files. Gerber readers that do not support low resolution will fail to read a significant fraction of Gerber files.

### 8.2.2 Rectangular Hole in Standard Apertures

Rectangular holes in standard apertures are deprecated since revision 2015.06. They occur very rarely in legacy files.



In addition to the round hole described in section 4.4 older versions of this specification also allowed rectangular holes. Rectangular holes do not rotate with the aperture, according to these historic specifications. This is very counterintuitive and a source of errors. Rectangular holes were deprecated because of this problem, and because rectangular holes are not very useful in the first place. Do not use them. If you need a rectangular hole construct a macro aperture.

The syntax of a rectangular hole was common to all standard apertures:

**hole = x\_hole\_size Y y\_hole\_size**

The parameters specify the X and Y sizes of the hole. Decimals >0.

The hole must strictly fit within the standard aperture. It is centered on the aperture.



#### Example:

```
%FSLAX26Y26*%  
%MOMM*%  
%ADD10C,10X5X5*%  
%ADD11C,1*%  
G01*  
%LPD*%  
D11*  
X-25000000Y-1000000D02*  
X25000000Y1000000D01*  
D10*  
X0Y0D03*
```

M02\*

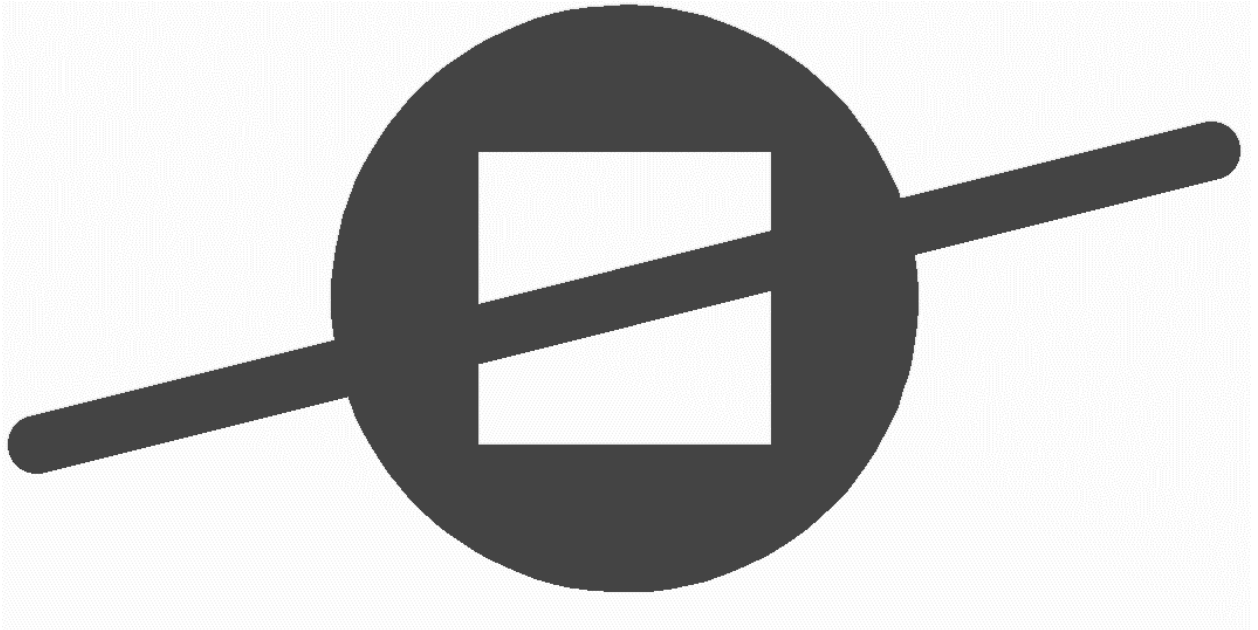

52. Standard (circle) aperture with a rectangular hole above a draw

Note that the draw is visible through the hole.

Rectangular holes appear very rarely in legacy files.

### 8.2.3 Draws and Arcs with Rectangular Apertures

The effect of stroking a line segment with a rectangular aperture is illustrated below. If the rectangle aperture is aligned with the line being stroked the result is a draw with line endings which have right angles:



Line being stroked

Aperture

Draw

53. Creating a draw: the aperture is aligned with line

If the rectangle is not aligned the result is as in the illustration below. The rectangle is *not* automatically rotated to align with the line being stroked.



Line being stroked

Aperture

Draw

54. Creating a draw: the aperture is not aligned with line



This was only allowed with the solid rectangle *standard* aperture. Other standard apertures or macro apertures that fortuitously have a rectangular shape are not allowed.

This option was deprecated in 2020.09. Drawing with rectangular was never used often, even less at other angles than multiples of 90°. A developer of Gerber input will get a long way if he only implements a warning on interpolations with rectangular apertures.

### 8.2.4 Macro Primitive Code 2, Vector Line

Primitive 2 was deprecated in 2015. It occurs but very rarely in legacy files.

Primitive 2 is identical to primitive 20. See 4.5.1.4.

### 8.2.5 Macro Primitive Code 22, Lower Left Line

Primitive 22 was deprecated in 2015. It occurs but very rarely in legacy files.

A lower left line primitive is a rectangle defined by its width, height, and the lower left point.

Modifier number	Description
1	Exposure off/on (0/1))
2	Rectangle width, a decimal $\geq 0$ .
3	Rectangle height, a decimal $\geq 0$ .
4	A decimal defining the X coordinate of lower left point.
5	A decimal defining the Y coordinate of lower left point.
6	A decimal defining the rotation angle around the <i>origin</i> (rotation is <i>not</i> around the center of the object)

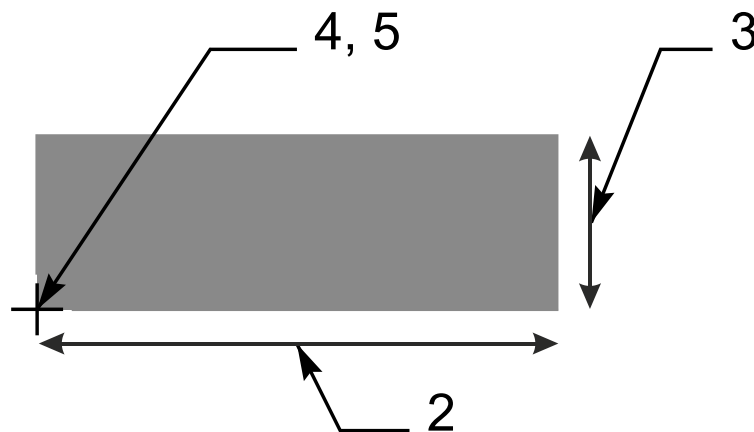

1. Line (lower left) primitive



**Example:**

```
%AMLIN2*22,1,6.8,1.2,0,0,0*%
```

### 8.2.6 Macro Primitive Code 6, Moiré

This primitive was deprecated in 2021. It is very rarely, if ever, used in legacy files.

The moiré primitive is a cross hair centered on concentric rings. Exposure is always on.

Parameter number	Description
1	Center point X coordinate.
2	Center point Y coordinate.
3	Outer diameter of outer concentric ring $\geq 0$ .
4	Ring thickness $\geq 0$ .
5	Gap between rings $\geq 0$ .
6	Maximum number of rings. An integer $\geq 0$ . The effective number of rings can be less if the center is reached. If there is not enough space for the inner ring it becomes a full disc.
7	Crosshair thickness $\geq 0$ . If the thickness is 0 there are no crosshairs.
8	Crosshair length $\geq 0$ . If the length is 0 there are no crosshairs.
9	Rotation angle, in degrees counterclockwise. The primitive is rotated around the origin of the macro definition, i.e. the (0, 0) point of macro coordinates.

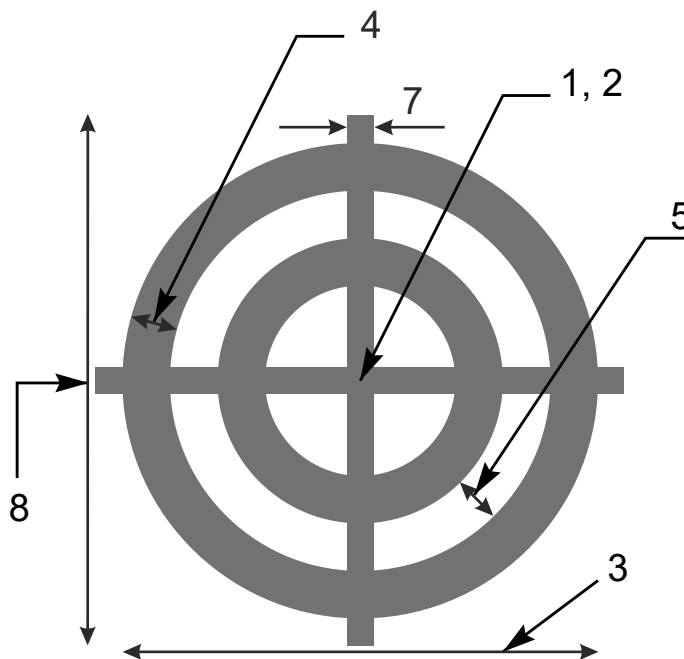

2. Moiré primitive

Below there is an example of an AM command that uses the moiré primitive.

**Example:**

```
%AMMOIRE*  
6,0,0,5,0.5,0.5,2,0.1,6,0*%
```

## 8.3 Deprecated Syntax Variations

### 8.3.1 Combining G01/G02/G03 and D01 in a single command.

This construction is deprecated since revision 2015.06.

The command codes G01, G02, G03 could be put at the beginning of the word containing a D01 command. The graphics state is then modified before the D01 is executed.

**Example:**

```
G01X100Y100D01*
```

G01 sets the interpolation mode to linear and this used to process the coordinate data X100Y100 from the same word as well as the coordinate data X200Y200 from the next word.

The syntax was as follows:

```
GnnD01 = ('G' ('01'|'02'|'03') coordinate_data 'D01') '**
```

This construction is a useless variation and is deprecated since revision 2015.06. However, it happens quite frequently in legacy files, so readers may want to support it.

## 8.3.2 Coordinate Data without Operation Code

Coordinate data *without explicit operation code* after a D01, in other words the modal use of D01, is deprecated since revision I1 from December 2012.

A D01 code sets the deprecated operation mode to interpolate. It remains in interpolate mode till any other D code is encountered. In sequences of D01 operations this allows omitting an explicit D01 code after the first operation.



### Example:

```
D10*
X700Y1000D01*
X1200Y1000*
X1200Y1300*
D11*
X1700Y2000D01*
X2200Y2000*
X2200Y2300*
```

The operation mode is *only* defined after a D01. The operation mode after a D02, D03 or an aperture selection (Dnn with nn≥10) is *undefined*. Therefore a file containing coordinates without operation code after a D02, D03 or an aperture selection (Dnn with nn≥10) is invalid.



**Warning:** Coordinate data without explicit operation code saves a few bytes but its exact use is not intuitive in relation to D03. The risk of scrap far outweighs the meager benefit.

## 8.3.3 Style Variations in Command Codes

Sometimes a word command such as G01 was spelled as G1, or g01, or G001. These variations were discouraged but tolerated. These variations were finally revoked in 2020.09 – only G01 style is allowed.

## 8.3.4 Deprecated usage of SR

These constructions are deprecated since revision 2016.01.

The command %SRX1Y1I0J0\*% strictly speaking starts a step and repeat of 1x1, i.e. no step and repeat at all. It is historically sometimes used as an alternative for an %SR\*% to close an SR statement. This is still used quite frequently.

Sometimes an SR command other than 1x1 such as %SRX2Y3I1,5J2.2\*% is put seemingly inside an SR statement. Its effect is then to terminate the current SR statement and start a new one with its parameters. This is used rarely.

Another deprecated variation is that an SR statement at the end of a file is not closed. The end of file M02\* is then an implicit close. This is used rarely.

Another variation is that the file header contains a %SRX1Y1I0J0\*%. This does not mean a futile 1x1 step and repeat is started. It just indicates that the file does not start with a step and repeat, which is obvious. This command can be ignored. This is used quite frequently.

## 8.4 Deprecated Attribute Values

The following values for the .AperFuntion attribute were deprecated.

Drawing	This generic value was replaced by a range of specific drawing types such as <code>FabricationDrawing</code> etc.
CutOut	PCB cut-outs. This is the generic term for a hole other than a drill hole.
Slot	PCB slots. This is a subset of the cut-outs. Which cut-outs are called slots is subjective. In case of doubt use the value <code>CutOut</code> .
Cavity	Cavities in a PCB.

## 8.5 Standard Gerber (RS-274-D)

The current Gerber layer format is also known as RS-274X or Extended Gerber. There was also a historic format called Standard Gerber or RS-274-D format.

Standard Gerber is technically obsolete. It and was revoked in revision I1 from December 2012 and superseded by RS-274X.

Standard Gerber is revoked and superseded by Extended Gerber, which is the current Gerber format. Consequently, Standard Gerber no longer complies with the Gerber specification. Files in that format can no longer be correctly called Gerber files. Standard Gerber files are not only deprecated, they are simply invalid.



It differs from the current Gerber format (RS-274X), in that it:

- did not support G36 and G37 codes
- did not support any extended commands
- did not support attributes

Standard Gerber did not allow defining the coordinate format or aperture shapes. It was incomplete as an image description format. It lacked the imaging primitives needed to unequivocally transfer information from PCB CAD to CAM.

The word “standard” is misleading here. Standard Gerber was standard NC format. It was not a standard image format: image generation needs a so-called wheel file, and that wheel file was not governed by a standard. The interpretation of a wheel files, and consequently of a Standard Gerber files, was subjective. In Extended Gerber (RS-274X) image generation is fully governed by the standard. Extended Gerber is the true image standard.

Standard Gerber had major drawbacks compared to the current Gerber format and did not offer a single advantage. Standard Gerber is obsolete. There is not a single valid reason to use standard Gerber rather than Extended Gerber.

Always use Extended Gerber (RS-274X). Never use Standard Gerber.

 **Warning:** The responsibility of errors or misunderstandings about the wheel file when processing a Standard Gerber file rests solely with the party that decided to use revoked Standard Gerber, with its non-standardized wheel file, rather than Extended Gerber, which is unequivocally and formally standardized.

## 9 References

---

*American National Standard for Information Systems — Coded Character Sets — 7-Bit American National Standard Code for Information Interchange (7-Bit ASCII), ANSI X3.4-1986*

<https://en.wikipedia.org/wiki/MD5>

<https://en.wikipedia.org/wiki/Unicode>

<https://en.wikipedia.org/wiki/UTF-8>

[https://en.wikipedia.org/wiki/ISO\\_8601](https://en.wikipedia.org/wiki/ISO_8601)

[https://en.wikipedia.org/wiki/Binary\\_image](https://en.wikipedia.org/wiki/Binary_image)

[https://en.wikipedia.org/wiki/Zip\\_\(file\\_format\)](https://en.wikipedia.org/wiki/Zip_(file_format))

<https://tools.ietf.org/html/rfc4122>

[https://msdn.microsoft.com/en-us/library/windows/desktop/aa378623\(v=vs.85\).aspx](https://msdn.microsoft.com/en-us/library/windows/desktop/aa378623(v=vs.85).aspx)

[https://developer.apple.com/library/mac/documentation/Foundation/Reference/NSUUID\\_Class](https://developer.apple.com/library/mac/documentation/Foundation/Reference/NSUUID_Class)

The Inventor's Dilemma: The Remarkable Life of H. Joseph Gerber, by David Gerber.

<https://tatsu.readthedocs.io/en/stable/>. Documentation for the TatSu PEG parser generator.

[https://en.wikipedia.org/wiki/Parsing\\_expression\\_grammar](https://en.wikipedia.org/wiki/Parsing_expression_grammar)

<https://bford.info/packrat/> Bryan Fords page on parsing expression grammars.

## 10 History

---

The Gerber format derives its name from the former Gerber Systems Corp. A leading supplier of vector photoplotters from the 1960s onwards, Gerber based its plotter input on a subset of the EIA RS-274-D NC format, and in 1980, it published a well-written specification titled "Gerber Format: a subset of EIA RS-274-D; plot data format reference book". The format was so well suited for its task that it was widely adopted and became the de-facto standard format for vector plotters, known as *Standard Gerber*.

Vector photoplotters are NC machines, and Standard Gerber, which is dedicated to vector photoplotters, is an NC format. As of the 1980s, vector photoplotters started losing ground to raster plotters. Based on bitmap technology, these newer devices demanded rather more than a simple NC format, so Gerber extended the original NC format with so called "Mass Parameters", converting it to a fully-fledged image file format. This resulted in a family of effective image description formats designed specifically to drive Gerber's PCB devices and raster plotters. In 1998 Gerber Systems Corp. was taken over by Barco and incorporated into its PCB division – Barco ETS, now Ucamco. At this point, Barco drew all the variants in Gerber's family of formats into a single standard image format.

On September 21, 1998 Barco-Gerber published the Gerber RS-274X Format User's Guide. The format became known as Extended Gerber or GerberX. This is a full image description format, which means that an Extended Gerber file contains the complete description of a PCB layer, providing everything needed for an operator to generate a PCB image, and enabling any aperture shape to be defined. Unlike Standard Gerber, it does not need the support of additional external files, and it specifies planes and pads clearly and simply without the need for painting or vector-fill. The Extended Gerber format quickly superseded Standard Gerber as the de facto standard for PCB image data, and is sometimes called "the backbone of the electronics industry". A sequence of revisions clarifying the specification was published over the years, culminating in revision H of January 2012.

During 2012, Ucamco reviewed the entire format in depth in "the great reform". Over 10.000 files from all over the world were gathered into a representative library to help establish current practice. Rarely used and historic format elements were deprecated. Format elements with conflicting interpretations in the market were either deprecated or clarified. The specification document itself was re-organized, the quality of the text and the drawings improved and many new drawings were added. This resulted in The Gerber Format Specification, revision I1 published in December 2012. Revisions I2, I3 and finally I4 from November 2013 further improved the document. The result was a powerfully clear and simple format, without needless embellishments, focused on the current needs of the PCB industry. This version of the Gerber Format was developed by Karel Tavernier and Rik Breemeersch. They were assisted by an advisory group including Ludek Brukner, Artem Kostyukovich, Jiri Martinek, Adam Newington, Denis Morin, Karel Langhout and Dirk Leroy. Grateful thanks are extended to all those who helped the development of the revision by posting their questions, remarks and suggestions on the Ucamco website. Particular thanks are due to Paul Wells-Edwards whose insightful comments contributed substantially to the revision.

Until this point, Gerber was purely an image description format. Recognizing that a PCB image must be supported with meta-information that describes, say, the function of an image file in the layer structure, Ucamco realized that it could convey that information clearly and unequivocally using attributes. Accordingly, and in June 2013, the company publicly proposed to extend the Gerber format using attributes, and invited feedback on its proposal from the Gerber user community. The outcome of this was revision J1, completed in February 2014, during which Gerber got its attributes. It was a major step forward for the format, at least on a par with the changes made when Standard Gerber became Extended Gerber. Sometimes called the second extension, the latest version of the Gerber format is known as Gerber version 2, or X2 (as



opposed to X1, which is Gerber without attributes). Gerber version 2 is fully backward compatible as attributes do not affect the image at all. Subsequent revisions, J2 to J4, clarified the specification and added new standard attributes. Gerber version 2 was developed by Karel Tavernier, Ludek Brukner and Thomas Weyn. They were assisted by an advisory group including Roland Polliger, Luc Samyn, Wim De Greve, Dirk Leroy and Rik Breemeersch.

In September 2014 Ucamco published an open letter declaring Standard Gerber obsolete and revoking it.

In August 2015, Ucamco published a draft specification *adding nested step and repeat* and block apertures to make panel descriptions more efficient, calling for comments from the user community. In November 2016 the review process was closed after substantial input and modifications and the final version included in revision 2016.12. This revision was developed by Karel Tavernier and Rik Breemeersch.

Early in 2015, the entire specification was reviewed once again by Karel Tavernier, Thomas Weyn and Artem Kostyukovich focused on making the specification easier to read and understand, while taking great care to ensure consistent and precise terminology. Some further elements were identified as superfluous and were deprecated. Not least, special attention was given to the 'Overview' chapter, with the aim of turning it into a tutorial that can be understood by non-experts. The result of this work is revision 2015.06.

In July 2016 Karel Tavernier from Ucamco published a draft specification to include netlist information in Gerber for public review. Several revisions of the draft were triggered by input from users. The final version was included in revision 2016.11 from November 2, 2016.

In March 2017 Karel Tavernier from Ucamco published a draft specification to include fab documentation in Gerber for public review.

In May 2020 Karel Tavernier from Ucamco published a specification for including component information in Gerber, aka X3.

# 11 Revisions

---

## 11.1 Revision 2021.11

Several improvements in the description of component attributes suggested by Bruce McKibben. Improved the text of the .CRot spec, as suggested by Urban Bruhin. Corrected a typo, pointed out by Bradley Lin. Corrected an error in the EBNF grammar of .Part, pointed out by Paul M. Johnson. Corrected an error in 4.2.1 and 4.9.1 pointed out by Grzegorz Kimbar. Corrected a large number of typos and errors pointed out by Frog Chen – we expressly thank him for his very careful review of the spec.

## 11.2 Revision 2021.04

We fixed errors and typos pointed out by Bruce Mc.Kibben and Jim J. Jewett - we thank them for the very careful proof reading. The definition of the coordinate system was added to 4.2, as suggested by Graham Wideman, who helpfully supplied the illustrations.

Revision 2021.04 was developed by Karel Tavernier.

## 11.3 Revision 2021.02

Deprecated single quadrant mode (G74) and macro primitive code 6 (moiré).

Now includes a formal grammar for the complete format. See 3.5.

Several typos were fixed; thanks to Nick Meeker and Kevin Shi for their careful review. The term 'data block' was replaced by 'word' to eliminate confusion with aperture blocks.

Revision 2021.02 was developed by Karel Tavernier.

## 11.4 Revision 2020.09 – X3

In March 2020 a specification for including component information – Gerber X3 2020.03 – was published. Gerber X3 was developed in discussion with a team of people. Karel Tavernier developed a prototype specification which was circulated privately with Wim De Greve, Jean-Pierre Charras, Thiadmer Riemersma, Bruce McKibben and Rafal Powierski in December 2018. In intense discussion among this group the draft went through five revisions until a first public draft was published in October 2019, calling for input from the user community. The review process was closed in February 2020 with the publication of the separate X3 specification, now merged in this document.

This separate specification on components is now merged into this main specification.

Gerber now accepts Unicode characters for attribute values that contain user-defined meta-information, and therefore may require special characters and other languages than English.

Draws with rectangular apertures were deprecated, see 8.2.3, as were some style variations in word commands, see 8.3.3.

Clarified the semantics of the .GenerationSoftware attribute. Specified more clearly how drill files must be constructed, as suggested by Wim De Greve and Luc Samyn.

Fixed errors pointed out by Greg Huangqi and Jim J. Jewett. Especially Jim J. Jewett reviewed the specification in great detail. Replaced the unusual term 'modifier' with the more usual term 'parameter'.

Revision 2020.09 was developed by Karel Tavernier.

## 11.5 Revision 2019.09

Replaced the option [Filled|NotFilled] on the ViaDrill value of the .AperFunction attribute with the more specific IPC-4761 types, see 5.6.10.

Revision 2019.09 was developed by Karel Tavernier.

## 11.6 Revision 2019.06

The .AperFunction values CutOut, Slot and Cavity were deprecated. See 8.3.

Made it more explicit that macro aperture names cannot be reused. Corrected an error in the examples pointed out by Abe Tusk, and in 2.1, pointed out by Radim Halíř.

Revision 2019.06 was developed by Karel Tavernier.

## 11.7 Revision 2018.11

Removed the .PF attribute, and replaced its content by an additional optional field to the .P attribute. See 5.6.14.

Fixed a number of typos and minor errors pointed out by Jörg Naujoks, Rik Breemeersh and Radim Halíř.

Revision 2018.11 was developed by Karel Tavernier.

## 11.8 Revision 2018.09

Corrected an error in the polygon aperture, section 4.4.5, and polygon primitive, section 4.5.1.7. Clarified the rotation of the deprecated rectangular holes in apertures, section 8.2.2 These issues were pointed out by Remco Poelstra.

Corrected an error in the moiré primitive specification, section 8.2.6. The error was pointed out by Vasily Turchenko.

Clarified how object attributes are attached to regions, triggered by remarks from Radim Halíř.

Defined allowed range of the scale factor in 4.9.5, as suggested by Andreas Weidinger.

Defined orientation of text mirroring in section 5.6.12. Triggered by Nicholas Meeker.

Nicholas Meeker, Andreas Weidinger, Radim Halíř and Denis Morin carefully proofread the document, which resulted in many text corrections.

Revision 2018.09 was developed by Karel Tavernier.

## 11.9 Revision 2018.06

Removed PressFit option from the ComponentPad attribute value; it is also a ComponentDrill option and that is sufficient.

Clarified pad attribute values for via, component, SMD, BGA on inner layers. Clarified FS command, see 4.1 and 8.2.1. Fixed broken links to references indicated by Vasily Turchenko.

Revision 2018.06 was developed by Karel Tavernier.

## 11.10 Revision 2018.05

Added .PF attribute, as suggested by Matthew Sanders.

Corrected errors in an example in 4.9.1 pointed out by Erik Forwerk. Corrected errors in the SR definition and Backus-Naur form pointed out by Remco Poelstra, see 4.11. Simplified the Backus-Naur form of the region statement, see 4.10.2. Corrected an error in 5.4 pointed out by Dries Soentjens.

Revision 2018.05 was developed by Karel Tavernier.

## 11.11 Revision 2017.11

Allow the .N attribute not only on copper layers but also on plated drill layers, see 5.6.13.

Remove .FileFunction value Keep-out. Use Profile instead.

Specified that to combine files zip is the only allowed archive format, as suggested by Rafal Powierski.

Simplified the Backus-Naur form of aperture blocks, see 4.11.2. Added synoptic table with macro primitives in 4.5.1.1. Added synoptic table one with standard apertures in 4.4.1. Added Backus-Naur form of the region statement. Added link to the Reference Gerber Viewer in 1.3. Fixed typos pointed out by Forest Darling. Fixed a number or typos pointed out by Radim Halíř.

Revision 2017.11 was developed by Karel Tavernier.

## 11.12 Revision 2017.05

Added the new file attribute .SameCoordinates, see 5.6.5.

Added file functions Depthrout, Viafill, Vcut, and Vcutmap.

Created section 5.6.16 with guidelines on the use of attributes in fabrication data; added guidelines on how to define the PCB profile in 6.2.

Reorganized and edited the chapter Overview. Clarified section on zero-size apertures.

Corrected an error in the comment in example 6.6.2 pointed out by Nav Mohammed. Corrected errors in the examples in 5.6.5 pointed out by Rik Breemeersch,

Revision 2017.05 was developed by Karel Tavernier.

## 11.13 Revision 2017.03

Added section 5.6.16, specifying how to put text in the image.

Changed file function *Glumask* to *Glue*; added explanation; see 5.6.3.

Reorganized chapter 3.5. Extended section 4.10.5.

Corrections in 4.9.1, 4.9.5, 4.10.1 and in Aperture Attributes on Regions triggered by remarks from Remco Poelstra. Corrected an error in an example pointed out by Danilo Bargaen.

Revision 2017.03 was developed by Karel Tavernier.

## 11.14 Revision 2016.12 – Nested step and repeat

This is a major revision with powerful new imaging functions: 4.11, 4.9.3, 4.9.4 and 4.9.5. These allow nested step and repeat to define panels efficiently, see 4.11.3 and 4.11.4.

There are fixes for errors in examples, pointed out by Danilo Bargen and Urban Bruhin.

Revision 2016.12, and especially the new imaging function for panels was developed by Karel Tavernier and Rik Breemeersch. The first draft of these functions was published in August 2016. During the public review process. Thomas Weyn, Bruce McKibben, Masao Miyashita and Remco Poelstra provided essential input.

## 11.15 Revision 2016.11

This major revision allows to include the CAD netlist to Gerber files by adding three new standard object attributes – see 5.6.16 above. The goal of the Gerber CAD netlist is to facilitate upfront communication between the different parties involved in design, assembly and automation. The X2 attributes proposed include CAD netlists in Gerber fabrication data and allow to:

- Attach the component reference designator, pin number and net name to the component pads in the outer copper layers. This information is essential for a complete board display and for a complete board display. More importantly, the netlist provides a powerful checksum to guarantee PCB fabrication data integrity.
- Attach the netlist name to any conducting object on any copper layer. Lightweight viewers can then display netlists without the need for an algorithm to compute connectivity
- Attach the component reference to any object, e.g. to identify all the legend objects belonging to a given component, for example.

Several text improvements. Section 4.10.3 on regions clarified triggered by deep questions asked by Remco Poelstra.

Revision 2016.11 was developed by Karel Tavernier. Jean-Pierre Charras provided essential input on the CAD netlist, and further remarks by Remco Poelstra and Wim De Greve were included.

## 11.16 Revision 2016.09

New or modified attribute values – see 5.6.10:

- Replaced file function *Drawing* with *OtherDrawing*.
- Added the optional field *Filled|NotFilled* to *ViaDrill*.
- Added aperture function *EtchedComponent*.

Added object attributes – see 5.4. Object attributes attach information to individual graphical objects.

Corrected an error in example 4.10.4.6. The error was pointed out by Thomas van Soest and Siegfried Hildebrand. Clarified the syntax of attaching aperture attributes to regions. Added Perl script to show precisely how to calculate the .MD5. Several other clarifications.

Revision 2016.09 was developed by Karel Tavernier.

## 11.17 Revision 2016.06

Added a section on back-drilling job triggered by questions from Alexey Sabunin. See 6.6.1.

The .ProjectID UUID was changed to RFC4122; rewritten by Remco Poelstra. See 5.6.8.

Aperture function attributes were clarified triggered by remarks from John Cheesman. Drill sizes were clarified triggered by remarks from Jeff Loyer.

## 11.18 Revision 2016.04

Added PressFit label to component drill and pad attributes; see ComponentPad and ComponentDrill. Revoked default on current point.

Text improvements that do not change the format: Removed superfluous concept of level and replaced the name 'Level Polarity' by 'Load Polarity'. Various other text improvements.

## 11.19 Revision 2016.01

Added drill and pad functions for castellated holes. Added optional types break-out and tooling on MechanicalDrill.

Deprecated closing an SR with the M02.

Text improvements that do not change the format: Clarified .AperFunction attribute values. Clarified when to use of standard or user attributes. Clarified how aperture attributes can be set on regions.

## 11.20 Revision 2015.10

Added items to section Errors and Bad Practices.

Added file function attribute .FilePolarity.

Refined drawing .FileFunction attributes Replaced Mechanical by FabricationDrawing and Assembly by AssemblyDrawing. Added definitions to the drawing types. Added mandatory (Top|Bot) to .AssemblyDrawing, as suggested by Malcolm Lear. Added ArrayDrawing.

## 11.21 Revision 2015.07

The superfluous and rarely, if ever, used macro primitives 2 and 22 were revoked. The .AperFunction aperture attribute was simplified:

- Filled / NotFilled option is removed for the ViaDrill function
- ImpC / NotC option is removed from the Conductor function

## 11.22 Revision 2015.06

New file attributes were specified: *.GenerationSoftware* (5.6.5), *.CreationDate* (5.6.5) and *.ProjectId* (5.6.8).

The mistakenly omitted rotation parameter of the circle macro primitive was restored. Unicode escape sequences in strings are now defined.

Operation syntax combining the G and D codes in a single word were deprecated. The rectangular hole in standard apertures was deprecated. Usage of low resolutions and trailing zero omission in the FS command was deprecated.

The entire document was revised for clarity. The readability of the text was improved. The terminology was made consistent. The glossary was expanded. A number of additional images were added, including the Gerber file processing diagrams, command types diagram, aperture macro rotation illustration. Some of existing images were recreated to improve the quality. Several new tables were added to explain the relation between D code commands and graphics state parameters. The glossary was updated. The sections were rearranged.

From now the revision numbering follows the year.month scheme as in 2015.06.

## 11.23 Revision J3 (2014 10)

The .FileFunction values for copper and drill layers were extended to contain more information about the complete job.

## 11.24 Revision J4 (2015 02)

The .AperFunction values “Slot”, “CutOut” and “Cavity” were added. The text on standard attributes was made more explicit. An example of a poorly constructed plane was added.

## 11.25 Revision J2 (2014 07)

Attaching aperture attributes with regions was much simplified. A section about numerical accuracy was added.

## 11.26 Revision J1 (2014 02) – X2

This revision created Gerber X2 by adding attributes to what was hitherto a pure image format. See chapter 5. X2 is Gerber version 2, with “X1” being Gerber version 1, without attributes. Gerber X2 is backward compatible as attributes do not affect image generation.

## 11.27 Revision I4 (2013 10)

The commands LN, IN and IP were deprecated. The possibility of re-assigning D codes was revoked.

The regions overview section 4.10.1 was expanded and examples were added different places in 4.10 to further clarify regions. The chapters on command codes and syntax were restructured. The constraints on the thermal primitive parameters were made more explicit. Wording was improved in several places. The term ‘(mass) parameter’ was replaced by ‘extended command’.

## 11.28 Revision I3 (2013 06)

Questions about the order and precise effect of the deprecated commands MI, SF, OF, IR and AS were clarified. Coincident contour segments were explicitly defined.

## 11.29 Revision I2 (2013 04)

The “exposure on/off” parameter in macro apertures and the holes in standard apertures are sometimes incorrectly implemented. These features were explained in more detail. Readers and writers of Gerber files are urged to review their implementation in this light.

## 11.30 Revision I1 (2012 12)

**General.** The entire specification was extensively reviewed for clarity. The document was re-organized, the text and the drawings have been improved and many new drawings were added.



**Deprecated elements.** Elements of the format that are rarely used and superfluous or prone to misunderstanding have been deprecated. They are grouped together in the second part of this document. The first part contains the current format, which is clean and focused. *We urge all creators of Gerber files no longer to use deprecated elements of the format.*

**Graphics state and operation codes.** The underlying concept of the *graphics state* and operation codes is now explicitly described. See section 2.5 and 2.5. *We urge all providers of Gerber software to review their implementation in the light of these sections.*

**Defaults.** In previous revisions the definitions of the default values for the modes were scattered throughout the text or were sometimes omitted. All default values are now unequivocally specified in an easy-to-read table. See 2.5. *We urge all providers of Gerber software to review their handling of defaults.*

**Rotation of macro primitives.** The rotation center of macro primitives was clarified. See 4.5.3. *We urge providers of Gerber software to review their handling of the rotation of macro primitives.*

**G36/G37.** The whole section is now much more specific. *We urge providers of Gerber software to review their contour generation in this light.*

**Coordinate data.** Coordinate data without D01/D02/D03 in the same word can lead to confusion. It therefore has been deprecated. See 8.1.10. *We urge all providers of Gerber software to review their output of coordinate data in this light.*

**Maximum aperture number.** In previous revisions the maximum aperture number was 999. This was insufficient for current needs and numerous files in the market use higher aperture numbers. We have therefore increased the limit to the largest number that fits in a signed 32-bit integer.

**Standard Gerber.** Standard Gerber is revoked because it has many disadvantages and not a single advantage. *We urge all users of Gerber software not to use Standard Gerber any longer.*

**Incremental coordinates.** These have been deprecated. Incremental coordinates lead to rounding errors. *Do not use incremental coordinates.*

**Name change: area and contour instead of polygon.** Previous revisions contained an object called a polygon. This caused confusion between this object and a polygon aperture. These objects remain unchanged but are now called areas, defined by their contours. This does not alter the Gerber files.

**Name change: level instead of layer.** Previous revisions of the specification contained a concept called a layer. These were often confused with PCB layers and have been renamed as levels. This is purely narrative and does not alter the Gerber files.