



The Gerber Layer Format Specification

A format developed by Ucamco.
Named in honor of Joseph Gerber,
inventor, entrepreneur, and photo-plotting pioneer.

Revision 2026.05



Contents

Contents	2
Preface.....	8
1 Introduction	9
1.1 Scope and Target Audience	9
1.2 Further Resources.....	9
1.3 Reference Gerber Viewer	9
1.4 Copyright and Intellectual Property	10
2 Overview	11
2.1 File Structure	11
2.2 Apertures.....	11
2.3 Graphical objects.....	12
2.3.1 Draws and Arcs.....	13
2.3.2 Polarity.....	14
2.4 Blocks.....	15
2.5 Attributes	15
2.6 Operations (D01, D02, D03)	16
2.7 Graphics State.....	16
2.8 Commands Overview	19
2.9 Processing a Gerber File	20
2.10 Glossary.....	22
2.11 Annotated Example Files	25
2.11.1 Example: Two Square Boxes	25
2.11.2 Example: Polarities and Apertures	27
2.12 Conformance	31
3 Syntax	32
3.1 Character Set	32
3.2 Formal Grammar	32
3.3 Commands.....	34
3.4 Data Types	36
3.4.1 Integers.....	36
3.4.2 Decimals.....	36
3.4.3 Strings	36
3.4.4 Fields	37
3.4.5 Names	37

3.5 Grammar of the Gerber Layer Format	38
3.6 File Extension, MIME Type and UTI	45
4 Graphics	46
4.1 Comment (G04).....	46
4.2 Coordinate Commands.....	47
4.2.1 Unit (MO)	48
4.2.2 Format Specification (FS)	49
4.3 Aperture Definition (AD).....	50
4.3.1 AD Command	50
4.3.2 Examples	51
4.3.3 Zero-size Apertures	51
4.4 Standard Aperture Templates.....	52
4.4.1 Overview.....	52
4.4.2 Circle	52
4.4.3 Rectangle.....	54
4.4.4 Obround.....	55
4.4.5 Polygon.....	56
4.4.6 Transparency of Holes	57
4.5 Aperture Macro (AM).....	58
4.5.1 Primitives	60
4.5.2 Exposure Parameter	70
4.5.3 Rotation Parameter	71
4.5.4 Macro Variables and Expressions.....	72
4.5.5 Examples	76
4.6 Set Current Aperture (Dnn).....	79
4.7 Plot State Commands (G01,G02,G03,G75).....	80
4.7.1 Linear Plotting (G01).....	80
4.7.2 Circular Plotting (G02, G03, G75)	81
4.8 Operations (D01/D02/D03)	86
4.8.1 Overview.....	86
4.8.2 Plot (D01).....	88
4.8.3 Move (D02).....	88
4.8.4 Flash (D03).....	89
4.8.5 Example.....	89
4.9 Aperture Transformations (LP, LM, LR, LS).....	90
4.9.1 Overview.....	90
4.9.2 Load Polarity (LP)	92
4.9.3 Load Mirroring (LM)	92
4.9.4 Load Rotation (LR).....	92
4.9.5 Load Scaling (LS)	93
4.9.6 Example.....	93
4.10 Region Statement (G36/G37).....	96

4.10.1 Region Overview.....	96
4.10.2 Region Statement Syntax	96
4.10.3 Valid Contours	98
4.10.4 Examples	100
4.10.5 Copper Pours, Power and Ground Planes	117
4.11 Block Aperture (AB)	120
4.11.1 Overview of block apertures.....	120
4.11.2 AB Statement Syntax.....	120
4.11.3 Usage of Block Apertures	123
4.11.4 Example.....	124
4.12 Step and Repeat (SR).....	126
4.13 End-of-file (M02)	130
4.14 Numerical Accuracy	131
4.14.1 Visualization.....	131
4.14.2 Image Processing	131
5 Attributes	133
5.1 Attributes Overview	133
5.1.1 Comment attributes.....	135
5.2 File Attributes (TF).....	136
5.3 Aperture Attributes (TA).....	136
5.3.1 Aperture Attributes on Regions	137
5.4 Object Attributes (TO).....	137
5.5 Delete Attribute (TD).....	138
5.6 Standard Attributes.....	139
5.6.1 Overview.....	139
5.6.2 .Part	141
5.6.3 .FileFunction	142
5.6.4 .FilePolarity	147
5.6.5 .SameCoordinates	148
5.6.6 .CreationDate.....	148
5.6.7 .GenerationSoftware	149
5.6.8 .ProjectId	149
5.6.9 .MD5	150
5.6.10 .AperFunction	151
5.6.11 .DrillTolerance.....	160
5.6.12 .FlashText.....	160
5.6.13 .N (Net)	162
5.6.14 .P (Pin).....	164
5.6.15 .C (Component Refdes)	165
5.6.16 . Cxxx (Component Characteristics).....	166
5.7 Text in the Image.....	168
5.8 Examples	169

6	PCB Fabrication and Assembly Data	171
6.1	Structure	171
6.2	Mandatory Attributes	171
6.3	Alignment	171
6.4	Pads	171
6.5	The Profile	171
6.6	Drill/rout files	172
6.6.1	Backdrilling	172
6.6.2	Example Drill File	173
6.7	Drawings and Data	176
6.8	The CAD Netlist	177
6.8.1	Benefits of Including the CAD Netlist	177
6.8.2	IP Considerations	178
6.9	Component Data	179
6.9.1	Overview	179
6.9.2	Assembly Data Set	179
6.9.3	Annotated Example Component Layer	180
7	Errors and Bad Practices	182
7.1	Errors	182
7.2	Bad Practices	184
8	Deprecated Format Elements	186
8.1	Deprecated Commands	186
8.1.1	Overview	186
8.1.2	Axis Select (AS)	188
8.1.3	Image Name (IN)	189
8.1.4	Image Polarity (IP)	190
8.1.5	Image Rotation (IR)	191
8.1.6	Load Name (LN)	192
8.1.7	Mirror Image (MI)	193
8.1.8	Offset (OF)	194
8.1.9	Scale Factor (SF)	195
8.1.10	Single-quadrant arc mode (G74)	196
8.2	Deprecated Command Options	200
8.2.1	Format Specification (FS) Options	200
8.2.2	Rectangular Hole in Standard Apertures	201
8.2.3	Draws and Arcs with Rectangular Apertures	202
8.2.4	Macro Primitive Code 2, Vector Line	203
8.2.5	Macro Primitive Code 22, Lower Left Line	203
8.2.6	Macro Primitive Code 6, Moiré	204
8.3	Deprecated Syntax Variations	206

8.3.1 Combining G01/G02/G03 and D01 in a single command.....	206
8.3.2 Coordinate Data without Operation Code.....	206
8.3.3 Style Variations in Command Codes.....	206
8.3.4 Deprecated usage of SR.....	207
8.4 Deprecated Attribute Values.....	207
8.5 Standard Gerber (RS-274-D).....	208
9 References.....	209
10 History.....	210
11 Revisions	212
11.1 Revision 2026.05	212
11.2 Revision 2024.05	212
11.3 Revision 2023.08	212
11.4 Revision 2023.03	212
11.5 Revision 2022.02	212
11.6 Revision 2021.11	213
11.7 Revision 2021.04	213
11.8 Revision 2021.02 – Formal grammar	213
11.9 Revision 2020.09 – X3	213
11.10Revision 2019.09	214
11.11Revision 2019.06	214
11.12Revision 2018.11	214
11.13Revision 2018.09	214
11.14Revision 2018.06	214
11.15Revision 2018.05	215
11.16Revision 2017.11	215
11.17Revision 2017.05	215
11.18Revision 2017.03	215
11.19Revision 2016.12 – Nested step and repeat.....	216
11.20Revision 2016.11	216
11.21Revision 2016.09	216
11.22Revision 2016.06	217
11.23Revision 2016.04	217
11.24Revision 2016.01	217
11.25Revision 2015.10	217
11.26Revision 2015.07	217
11.27Revision 2015.06	217
11.28Revision J4 (2015 02)	218
11.29Revision J3 (2014 10)	218
11.30Revision J2 (2014 07)	218

11.31 Revision J1 (2014 02) – X2	218
11.32 Revision I4 (2013 10)	218
11.33 Revision I3 (2013 06)	218
11.34 Revision I2 (2013 04)	219
11.35 Revision I1 (2012 12)	219

Preface

The Gerber format is the de facto open standard for printed circuit board (PCB) design data transfer. As a UTF-8 human-readable format Gerber is portable and easy to debug. It is compact and unequivocal, and simple - there are just 27 commands. Every PCB design system outputs Gerber files and every PCB fabrication software inputs them. Implementations are thoroughly field-tested. Gerber's widespread availability allows PCB professionals to exchange PCB design data securely and efficiently. It has been called "the backbone of the electronics fabrication industry".

Gerber is at its core is an open vector format for 2D binary images specifying PCB copper layers, solder mask, legend, etc. Attributes transfer meta-information with the images. Attributes are akin to labels expressing, for example, that an image represents the top solder mask, or that a pad stack is a via or component stack, and which components are positioned where. Attributes transfer the meta-information necessary for fabrication and assembly. A set of well-constructed Gerber files reliably and productively transfers PCB fabrication from design to fabrication, and component information to assembly.

Although other data formats have appeared, they have not displaced Gerber. The reason is simple. Any problems in PCB fabrication data transfer are not due to limitations in the Gerber format but are due to poor practices and poor implementations. The new formats are more complicated and less transparent. To quote Günther Schindler: *"There are no superfluous, production-specific attributes like in other CAM formats. Gerber X2 is simple and tidy."* Poor practices and poor implementations in unfamiliar, new and complicated formats are more damaging than in a well-known, well-tested and simple format. The industry has not adopted new formats. Gerber remains the standard.

Ucamco continuously clarifies this document and adapts it to current needs based on input from the user community. Ucamco thanks the individuals that help us with comments, criticism, and suggestions.

The Gerber format was named after Joseph Gerber, who fled his native Austria from the Nazis, and arrived in the USA with his mother, penniless. With his technical genius and hard work, he became a very successful inventor and technical entrepreneur. The American dream come true. Mr. Gerber pioneered photoplotting in PCB fabrication, which is the link with the format. Ucamco is honored to look after a format called after this brilliant man.

The emergence of Gerber as a standard for PCB fabrication data is the result of efforts by many individuals who developed outstanding software for Gerber files. Without their dedication there would be no standard format in the electronics fabrication industry. Ucamco thanks these dedicated individuals.

Karel Tavernier
Managing Director,
Ucamco

1 Introduction

1.1 Scope and Target Audience

This document specifies the Gerber layer format, a UTF-8 format for representing PCB fabrication data. The Gerber format is the de facto standard in the printed circuit board (PCB).

This specification is intended for developers and users of Gerber software. A basic knowledge of PCB design or fabrication is assumed, and knowledge about PCB CAD/CAM is helpful.

1.2 Further Resources

The Ucamco website contains articles about the use of the Gerber format as well as sample files. For more information about Gerber or Ucamco see www.ucamco.com, or mail to gerber@ucamco.com

Ucamco strives to make this specification easy to read and unequivocal. If you find a part of this specification unclear, please ask. Your question will be answered, and it will be considered to improve this document. We are grateful for any suggestions for improvement.

1.3 Reference Gerber Viewer

Ucamco provides a reference Gerber file viewer - free of charge – at gerber-viewer.ucamco.com.

The Reference Gerber Viewer provides an *easy-to-use reference* for both X1 and X2 Gerber files. - the utmost care was taken to display valid Gerber files correctly. It gives a clear warning on risky errors. It is a convenient complement to the written specification. (The specification has precedence if it conflicts with the viewer.)

The Reference Gerber Viewer is an easy tool to *review PCB fabrication data*. For completeness, it also displays drill files in XNC, Excellon and other NC formats as well as netlists in IPC-D-356. If X2 is used the layer structure is displayed, and the function of all objects can be checked – e.g. whether a drill hole is a via or a component hole.

As the Reference Gerber Viewer is a cloud-based online web service there is no software to download, install and maintain –it is always up to date. It is simple and easy to learn. It offers the following benefits:

- *For developers*, it provides an easy way to test their Gerber output and to answer questions about the interpretation of the specification.
- *For users of Gerber files*, it provides an easy way to check the file they have received or are about to send, and to settle discussions about the interpretation of a file.

You are allowed to integrate a link to the online reference viewer in your website. Email us a gerber@ucamco.com for more information.

1.4 Copyright and Intellectual Property

© Copyright Ucamco NV, Gent, Belgium

Ucamco owns copyrights in this document. All rights reserved. No part of this document or its content may be re-distributed, reproduced or published, modified or not, translated or not, in any form or in any way, electronically, mechanically, by print or any other means without prior written permission from Ucamco. One reason Ucamco must retain its copyright in the Gerber Format® specification is to maintain the integrity of the standard.

The information contained herein is subject to change without prior notice. Revisions may be issued from time to time. This document supersedes all previous versions. Users of the Gerber Format®, especially software developers, must consult www.ucamco.com to determine whether new revisions were issued.

Ucamco developed the Gerber Format®. All intellectual property contained in this document is solely owned by Ucamco. By publishing this document Ucamco has not granted any license to or alienated any rights in the intellectual property contained in it.

Gerber Format® is a Ucamco registered trademark. By using the name Gerber this document or developing software interfaces based on this format, users agree, not to (i) rename the Gerber Format®; (ii) associate the Gerber Format® with data that does not conform to the Gerber format specification; (iii) develop derivative versions, modifications, or extensions without prior written approval by Ucamco; (iv) make alternative interpretations of the data; (v) communicate that the Gerber Format® is not owned by Ucamco, explicitly or implied. Whatever other conditions may apply, by using the name Gerber Format®, or the intellectual property contained in this document, developers of software interfaces for the Gerber Format®, agree to make a reasonable effort to comply with the latest revision of the specification, including the Conformance in section 2.12 to safeguard the integrity of the standard.

The material, information and instructions are provided AS IS without warranty of any kind, either express or implied. Ucamco does not warrant, or makes any representations regarding, the use of the information contained herein, the results of its use, non-infringement, merchantability, or fitness for a particular purpose. Ucamco shall not be liable for any direct, indirect, consequential, or incidental damages arising out of the use or inability to use the information contained herein. You are solely responsible for determining the appropriateness of using this information and assume any risks associated with it.

All product names cited are trademarks or registered trademarks of their respective owners.

2 Overview

2.1 File Structure

The Gerber layer format is a 2D binary vector image format: the image is defined by resolution-independent graphical objects. In binary or bi-level images each point takes one of two possible values, typically labeled black and white.

A *single* Gerber file specifies a *single* image. A Gerber file is complete: it does not need sidecar files or external parameters to be interpreted. One Gerber file represents one image. One image needs one Gerber file only.

A Gerber file is a *stream of commands*. The commands create a *stream of graphical objects* (see 2.2) that are put on the image plane to create the final image. Other commands add attributes to those objects or to the overall file. Attributes are akin to labels that add meta information to the objects. Attributes do not affect the image itself.

The commands are ordered. A Gerber file can be processed in a single pass. Names, parameters, and objects must be defined *before* they are used.

A Gerber file uses printable 7-bit ASCII characters for all commands and names defined in the specification – this fully covers image generation. For attribute values the complete UTF-8 encoding is allowed, as they can be human defined. This makes the files printable and human readable.

Below is a small example Gerber file that creates a circle of 1.5 mm diameter centered on the origin. There is one command per line.

```
%FSLAX26Y26*%  
%MOMM*%  
%ADD100C,1.5*%  
D100*  
X0Y0D03*  
M02*
```

2.2 Apertures

Apertures are 2D plane figures. Apertures typically are simple shapes, as in the examples below, but complex shapes can be created.



Apertures are the basic tools to create graphic objects. They can be replicated in the plane, optionally rotated, mirrored, and scaled. This replication is called flashing, from the days when these things were done with NC optical equipment. Flashes are used to create pads. Apertures can also be used to draw traces by stroking the aperture as a pen along a line segment.

There are several methods to define apertures: via standard apertures, macro apertures and block apertures. Apertures are identified by a unique aperture number.

The AD (Aperture Define) command creates an aperture based on an aperture template and parameter values giving it a unique D code or aperture number for later reference.

There are two kinds of aperture templates:

- Standard apertures. They are pre-defined: the circle (C), rectangle (R), obround (O) and regular polygon (P). See 4.4.
- Macro apertures. They are created with the AM (Aperture Macro) command. Any shape and parametrization can be created. They are identified by their given name. (See 4.5).

Standard apertures can be considered as built-in macro apertures. The example AD command below creates an aperture. The aperture number is 123. It uses standard aperture R with parameters 2.5 and 1.5 mm to create a rectangle of 2.5 by 1.5 mm.

```
%ADD123R,2.5X1.5%
```

Macros are a powerful feature of the Gerber format. Templates of any shape and parameters can be created. A file writer can easily define the apertures it needs. A file reader can handle any such aperture by implementing a single macro function. This single flexible mechanism replaces the need for a large - but always insufficient - set of built-in apertures. New apertures can be created without extending the format.

Block apertures are an ordered set of graphical objects. Block apertures are not created with templates. They are created by an AB statement, with the standard object creating commands of the Gerber format and assigns an aperture number to it (see 2.4).

An aperture has an *origin*. When an aperture is flashed, its origin is positioned at the coordinates in the flash command (see 4.8.4). The origin of a standard aperture is its geometric center. The origin of a macro aperture is the origin used in the AM command defining it. The origin of a block aperture is the origin used in the AB command defining it.

2.3 Graphical objects

A Gerber file creates an ordered stream of graphical objects. A graphical object represents a plane figure. It has a shape, a size, a position and a polarity (dark or clear). The stream of the graphical objects creates the final image by superimposing the objects on the plane in the order of the stream, with dark polarity objects darkening the plane and clear ones erasing all dark areas under them.

There are four types of graphical objects:

- **Draws** are straight-line segments stroked with a circle.
- **Arcs** are circular segments stroked with a circle.
- **Flashes** are replications of the current aperture in the image plane. Any valid aperture can be flashed (see 4.8.4). An aperture is typically flashed many times.
- **Regions** are defined by their contours (see 4.10.1). A contour is a closed sequence of connected linear or circular segments.

The solid circle *standard* aperture is the only aperture allowed for creating *draw or arc* objects. Other standard apertures or macro apertures that fortuitously have a circular shape are not allowed.

A circle aperture with diameter zero can be used for creating a draw or an arc. It creates graphical objects without an image which can be used to transfer non-image information, e.g., an outline.

2.3.1 Draws and Arcs

A *draw graphics object* is created by a command with D01 code in linear plot mode. The command strokes the straight-line segment with a solid circle standard aperture resulting in a line with thickness equal to the diameter of the circle and round endings. For the mathematically inclined, the draw object is the Minkowski sum of the circle and the straight line segment.

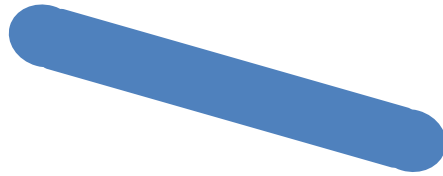

An *arc graphics object* is created by a command with D01 code in circular plot mode. In this case the command results in stroking a circular arc segment with a solid circle standard aperture. The *arc* has round endings, and its thickness is equal to the diameter of the stroking circle. For the mathematically inclined, the arc object is the Minkowski sum of the circle and the circular arc segment.

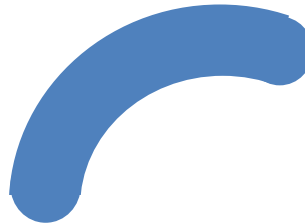

In PCB copper layers, tracks are represented by draws and arcs, pads by flashes and copper pours by regions. Tracks is then a generic name for draws and arcs.

2.3.2 Polarity

The final image of the Gerber file is the result of superimposing the graphics objects in the order of their creation. Objects have a polarity, either clear or dark. A dark polarity object darkens its image in the plane. Objects can overlap. A clear polarity object clears its image in *all objects beneath it (generated before)*. Subsequent dark objects may again darken the cleared area. See illustration below. Another example is in 4.10.4.6.

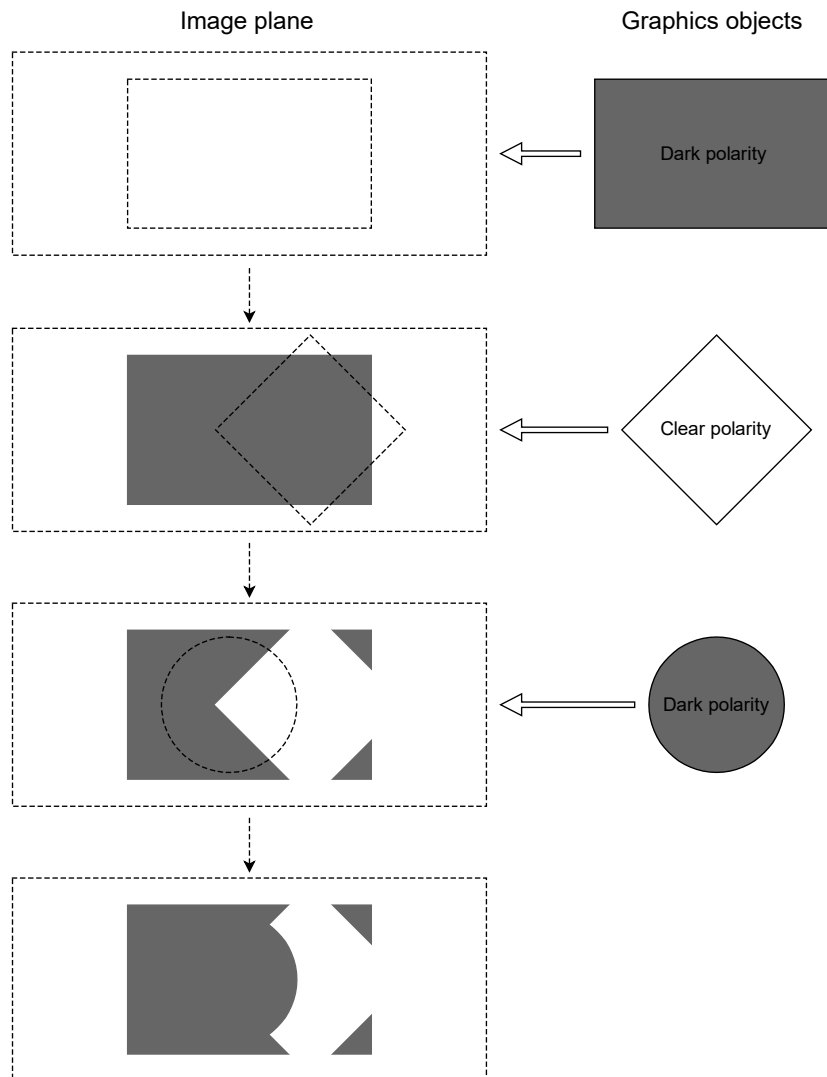

1. Superimposing objects with dark and clear polarities

An object is totally dark or totally clear. It cannot be partially dark and partially clear.

The *order* of superimposed objects with different polarities affects the final image.

The LP command sets the polarity mode, a graphics state parameter (see 4.9). Objects that are created when the polarity mode is dark are dark; when the mode is clear the objects are clear.

2.4 Blocks

A *block* is a substream of graphical objects that can be appended one or more times to the final graphical objects stream. Blocks can be mirrored, rotated, scaled, shifted and their polarity can be toggled. By using blocks repeated sub-images are defined only once, thus slashing file size, boosting processing speed and preserving the information that these sub-images are identical.

A block is *not* a macro of commands called repeatedly in the command stream. The command stream is processed sequentially, in one pass, without procedure or macro calls. Gerber is not a programming language.

Blocks can contain objects with different polarities (LPD and LPC). Blocks can overlap.

The origin of the block is the (0, 0) point of the file coordinate space.

Once a block is appended to the graphical objects stream its objects become part of the stream, and their effect does not depend on whether they were part of a block or not. A clear object in a block clears *all* objects beneath it, not only the objects contained in the block.

There are two commands to create a block: SR and AB.

2.5 Attributes

Attributes add meta-information to a Gerber file. These are akin to labels providing additional information about the file or features within. Examples of such meta-information are:

- ❑ The function of the file: is it the top solder mask, or the bottom copper layer etc.
- ❑ The function of a pad: is the pad a component pad, or a via pad, or a fiducial, etc.



Example:

This command defines an attribute indicating the file represents the top solder mask.

```
%TF.FileFunction,Soldermask,Top*%
```

Attributes can be attached to objects, apertures or to the complete file.

Attributes do not affect the image itself, they only add meta-information to the data. A Gerber reader will generate the correct image even if it ignores some or all attributes.

The attribute syntax provides a flexible and standardized way to add meta-information to the images, independent of the specific semantics or application.

Attributes are needed when PCB data is transferred from design to fabrication. The PCB fabricator needs more than just the image. For example, the solder mask around via pads needs dedicated clearances to achieve the specified via protection. Without these attributes, the fabricator has to guess which objects represent a via; figuring this out manually is a time consuming and error-prone process. The attributes transfer the design intent from CAD to CAM in an unequivocal and standardized manner. This is sometimes rather grandly called “adding intelligence to the image”.

Gerber files containing attribute commands (TF, TA, TO, TD) are called Gerber X2 files, files without attributes Gerber X1 files.

Attributes are described in detail in chapter 5.

2.6 Operations (D01, D02, D03)

D01, D02 and D03 are the *operations*. An *operation* is a command consisting of coordinates followed by an operation code. Operations change the current point and/or create graphics objects.



Example:

```
X100Y100D01*  
X200Y200D02*  
X300Y-400D03*
```

The operations have the following effect.

- An operation with a D02 is called a *move operation*. It moves the current point (see 2.7) to the coordinates. No graphical object is created.
- An operation with a D01 is called a *plot operation*. It defines a linear or circular line segment by plotting from the current point to the coordinates in the command. The effect of D01, e.g. whether a straight or circular segment is created, depends on the graphics state (see 2.7). These segments are converted to draw or arc objects by stroking them with the current aperture (see 2.3.1) outside a region statement (see 4.10). Within a region statement these segments form a contour defining a region.
- An operation with a D03 is called a *flash operation*. It creates a flash object by flashing (replicating) the current aperture at the coordinates. The origin of the current aperture is as specified by the coordinates.

2.7 Graphics State

The graphics state is a set of parameters affecting the result of the operation codes (see 2.6). Before an operation code is issued all graphics state parameters affecting it must be defined.

The most important graphics state parameter is the *current point*. This is a point in the image plane set implicitly by each operation command (D01, D02, D03) to the coordinates contained in that operation command after finishing.

All other graphics state parameters are set explicitly by corresponding commands. Their values remain constant until explicitly changed.

The table below lists the graphics state parameters. The column 'Constant or variable' indicates whether a parameter remains fixed during the processing of a file or whether it can be changed. The column 'Initial value' is the default value at the beginning of each file; if the default is undefined the parameter value must be explicitly set by a command in the file before it is first used.

Graphics state parameter	Value range	Constant or variable during file processing	Initial value
Coordinate Parameters			
Coordinate format	Coordinate resolution. See the FS command in 4.2.2	Constant	Undefined
Unit	mm or inch. See MO command in 4.2.1	Constant	Undefined
Generation state			
Current point	Point in plane	Variable	Undefined
Current aperture	Used for stroking and flashing. See D01 and D03 commands in 4.8.	Variable	Undefined
Plot state	Linear, clockwise circular, counterclockwise circular See G01, G02, G03 commands in 4.7	Variable	Undefined
Aperture transformation state			
Polarity	Dark or clear. See the LP command in 4.9.2	Variable	Dark
Mirroring	See the LM command in 4.9.3	Variable	No mirror
Rotation	See the LR command in 4.9.4	Variable	No rotation
Scaling	See the LS command in 4.9.5	Variable	No scaling

Graphics state parameters

The graphics state determines the effect of an operation. If a parameter that is required to perform an operation is undefined at the time of the operation the Gerber file is *invalid*. A graphics state parameter that is not needed can remain undefined.

The relevance of the graphics state parameters for the operations is represented in the table below.

Graphics state	Operation codes		
	D01	D02	D03
Coordinate format	Yes	Yes	Yes
Unit	Yes	Yes	Yes
Current point	Yes (plot start point)	No	No
	Yes/No refers to the explicit use of the complete current point. If an X and/or Y coordinate is omitted in the operation code the corresponding value from the current point is always taken; this is called modal coordinates.		
Current aperture	Yes outside a region statement. No inside a region statement	No	Yes
Plot mode	Yes	No	No
Polarity	Yes	No	Yes
Mirroring	Yes	No	Yes
Rotation	Yes	No	Yes
Scaling	Yes	No	Yes

Relevance of graphics state parameters for operation codes

2.8 Commands Overview

Command	Long name	Description	Ref.
G04	Comment	A human readable comment, does not affect the image.	4.1
MO	Mode	Set the unit to mm or inch.	4.2.1
FS	Format specification	Set the coordinate format, e.g. the number of decimals.	4.2.2
AD	Aperture define	Define a template-based aperture, assigns a D code to it.	4.3
AM	Aperture macro	Define a macro aperture template.	4.5
Dnn (nn≥10)		Set the current aperture to D code nn.	4.6
D01	Plot operation	Outside a region statement, create a draw or arc object with the current aperture. Inside add a draw/arc segment to the contour under construction. The current point is moved to draw/arc end point after the creation of the draw/arc.	4.8.2
D02	Move operation	Move the current point to the coordinate in the command. It does not create an object.	4.8.3
D03	Flash operation	Create a flash object with the current aperture. The current point is moved to the flash point.	4.8.4
G01		Set linear/circular mode to linear.	4.7.1
G02		Set linear/circular mode to clockwise circular.	4.7.2
G03		Set linear/circular mode to counterclockwise circular.	4.7.2
G75		A G75 must be called before creating the first arc.	4.7.2
LP	Load polarity	Load the polarity object transformation parameter.	4.9.2
LM	Load mirroring	Load the mirror object transformation parameter.	4.9.3
LR	Load rotation	Load the rotation object transformation parameter.	4.9.4
LS	Load scaling	Load the scale object transformation parameter.	4.9.5
G36		Start a region statement which creates a region by defining its contours.	4.10.
G37		End the region statement.	4.10
AB	Aperture block	Open a block aperture statement and assigns its aperture number or closes a block aperture statement.	4.11
SR	Step and repeat	Open or close a step and repeat statement.	4.12
TF	Attribute on file	Set a file attribute.	5.2
TA	Attribute on aperture	Add an aperture attribute to the dictionary or modify it.	5.3
TO	Attribute on object	Add an object attribute to the dictionary or modify it.	5.4
TD	Attribute delete	Delete one or all attributes in the dictionary.	5.5
M02		End of file.	4.13

Command Overview

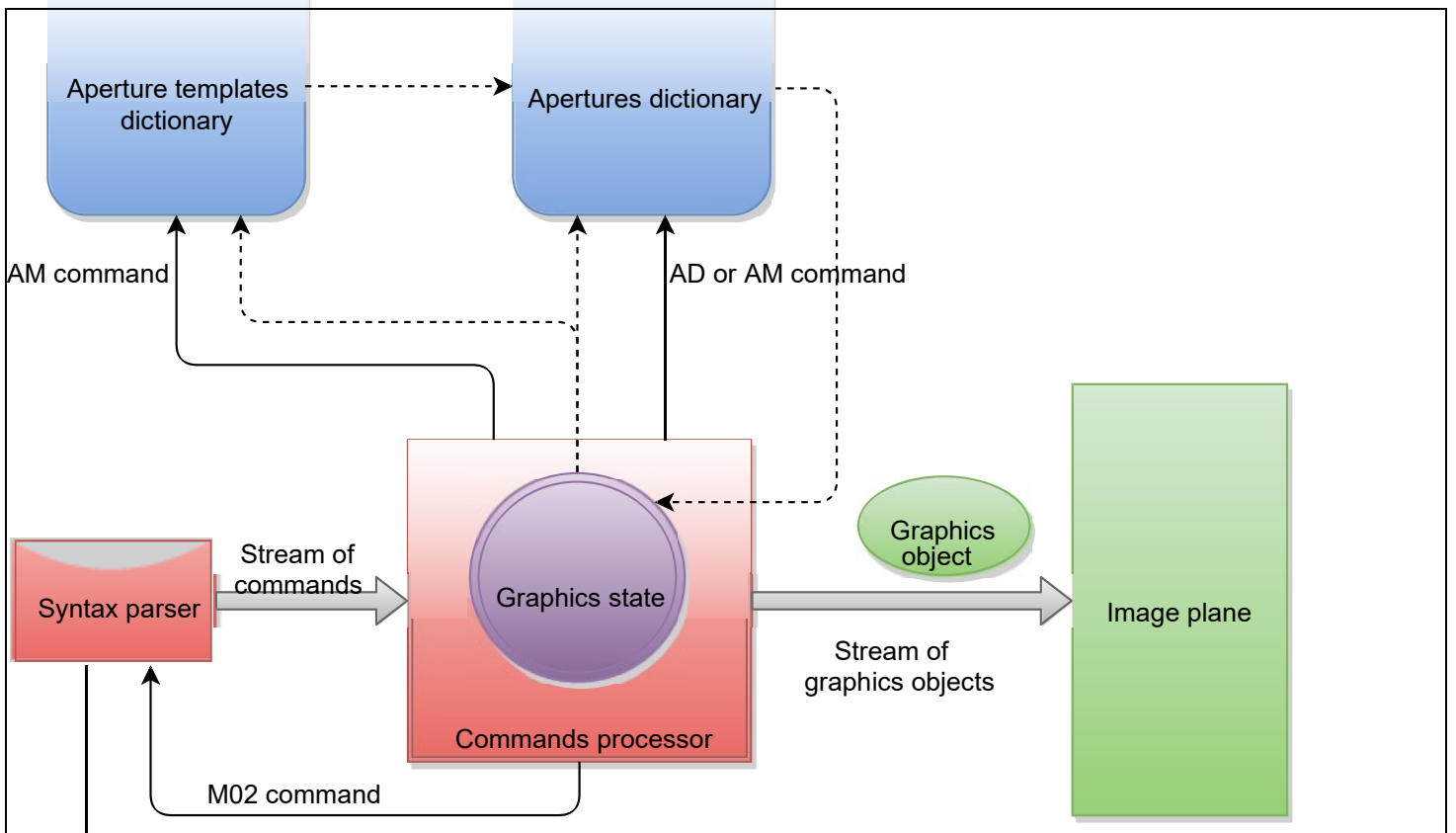

Legend

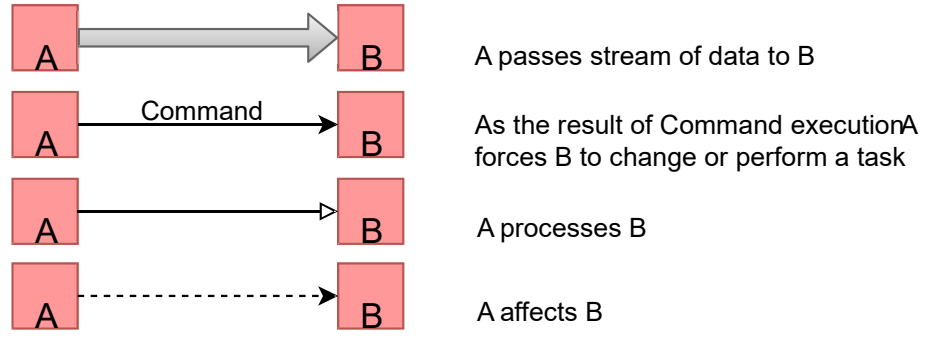

The syntax parser reads the Gerber file and produces the stream of commands to the command processor. The commands processor generates the according stream of graphical objects. All the created objects are superimposed on the image plane in order of their creation.

The *graphics state* is a core part of the command processor. How the processor creates graphical objects from the operation codes (see 2.3.2) depends on the graphics state. Conversely, the processor modifies the graphics state when processing certain commands (see 2.3.2).

The aperture template dictionary holds all the templates available. The AD command (see 4.3) instantiates the templates to apertures and adds them to the aperture library. Standard, or built-in, aperture templates are automatically added to the dictionary when file processing is started. Macro aperture templates are created with an AM command (see 4.5); they are added when the AM command is processed.

The *current aperture* is a graphics state parameter that is maintained by Dnn command (see 4.6). When the processor executes a Dnn command a referenced aperture from apertures dictionary is set as the current aperture.

The graphics state also affects the generation of aperture templates and apertures: the templates and apertures depend on 'coordinate format' and 'unit' graphics state parameters (see 2.3.2).

The graphical object stream is without state. Objects are superimposed as they are, in their order of appearance.

After processing the M02 command (see 4.13) the processor interrupts the syntax parser and stops the graphical objects generation.

The image above illustrates the processing of a Gerber file without attributes.

2.10 Glossary

AB statement: A statement defining a block aperture.

Aperture: A 2D shape that is used for stroking or flashing. (The name is historical; vector photoplotters exposed images on lithographic film by shining light through an opening, called aperture.) Apertures are identified by an aperture number.

Aperture macro: The content of an Aperture Macro (AM) command. Defines a custom aperture template by combining built-in primitives.

Aperture template: A template is used to create the specific apertures used in the file. The AD command defines the parameters to instantiate the template to a defined aperture. There are two types of templates: standard or built-in, and macros.

Aperture templates dictionary: The object that holds all the aperture templates.

Apertures dictionary: The object that holds all the apertures.

Arc: A graphical object created by a D01 command in a circular plot mode.

Attribute: Metadata that is attached to the file or to objects in it; it provides extra information without affecting the image.

Attributes dictionary: The object that holds all the current attributes during the processing of a Gerber file.

Binary image: A two-dimensional (2D) image represented by two colors, usually black and white.

Block: A substream of graphical objects that can be added to the final objects stream.

Circular plotting: Creating a circular segment (circular arc) that is either an arc graphical object or used as a circular contour segment.

Clear: Clearing or erasing part of the image in the image plane. When a graphical object with clear polarity is added to the stream it erases its shape from any image that was already there.

Command: Commands are the basic unit of a Gerber file. Commands create graphical objects, define apertures, manage attributes, modify the graphics state and so on. For compatibility with older format versions there are two command syntax styles: word commands and extended commands.

Command code: A code that identifies the command.

Contour: A closed sequence of connected linear or circular segments. Contours are used to create regions or outline primitives in macro apertures.

Coordinate data: A number whose interpretation is determined by the FS command. It is used to specify the X and Y coordinates of a point in the image plane and a distance or offset in the X and Y direction.

Coordinate format: The specification of how to convert coordinate data to coordinates. It is file-dependent and is defined by an FS command.

Current aperture: The graphics state parameter that specifies the last aperture selected by a Dnn command. The current aperture is always used to create flashes, draws and arcs.

Current point: The graphics state parameter that specifies the point in the plane used as a begin point of linear or circular plotting as the location flash.

Darken: Darken the shape of a graphical object on the image plane; this happens when a graphical object with dark polarity is added to the image.

Draw: A graphical object created by D01 command in linear plot mode.

File image: The binary image that is the visual representation of a Gerber file. It is created by superimposing the graphical objects in the plane.

Flash: A graphical object created by D03 or flash command.

Gerber file: A file in the Gerber format.

Gerber format: The vector image format defined by the current specification and used for representing a binary image.

Graphical object: A graphical object is a 2D object with a shape, a size, a position in the plane and a polarity (dark or clear). There are the following types: flash, draw, arc, or region. The file image is created by superimposing graphical objects on the image plane. Attributes can optionally be attached to a graphical object.

Graphics state: The set of parameters that at each moment determine how the operation codes create graphical objects. For example, it determines whether a D01 operation code creates a draw or an arc.

Header: The part of the file from the file beginning to the point where the first operation code is encountered. The header typically holds the definitions of file attributes, aperture definitions, file unit and coordinate format.

Image plane: The 2D plane in which the image defined by the file is created.

Plot mode: The graphics state parameter defining whether the D01 operation creates a linear, a clockwise or counterclockwise arc.

Interpolating: A deprecated term for plotting.

Linear plotting: Creating a straight segment that is either converted to a draw graphical object or used as a linear contour segment.

Macro aperture: An aperture template defined using AM command.

Operation: A command containing one of the operation codes D01, D02 or D03 and coordinate data. The operation code defines the type of operation that is performed with the coordinate data. Operations may create graphical objects, create contours, and change the current point of the graphics state.

Polarity: A graphics state parameter that can take the value dark or clear. It determines the polarity of the graphical objects generated. Dark means that the object marks the image plane in dark and clear means that the object clears or erases everything underneath it. See also 'Darken' and 'Clear'.

Region: A graphical object with an arbitrary shape defined by its contour.

Region statement: A statement creating a region by defining its contour.

Resolution: The distance expressed by the least significant digit of coordinate data. Thus, the resolution is the step size of the grid on which all coordinates are defined.

SR statement: A statement defining a block and step & repeating it.

Standard aperture: A built-in aperture template.

Standard attribute: A built-in attribute with predefined semantics. See also user attribute.

Statement: A coherent sequence of commands delimited by an open and close command defining a higher-level structure.

Stroke: To create a draw or an arc graphical object with the current aperture.

Track: Either a draw or an arc. Typically used for conductive traces on a PCB.

Unit: The measurement unit 'mm' or 'inch' used to interpret the coordinate data. The effective unit is stored as the value of the corresponding graphics state parameter.

User attribute: A third-party defined attribute to extend the format with proprietary meta-information.

Word: A sequence of characters ending with the '*' delimiter character. It is the low-level syntactical element of a Gerber file used to build commands.

2.11 Annotated Example Files

These annotated sample files illustrate the Gerber layer format to make the formal specification easier to read.

2.11.1 Example: Two Square Boxes

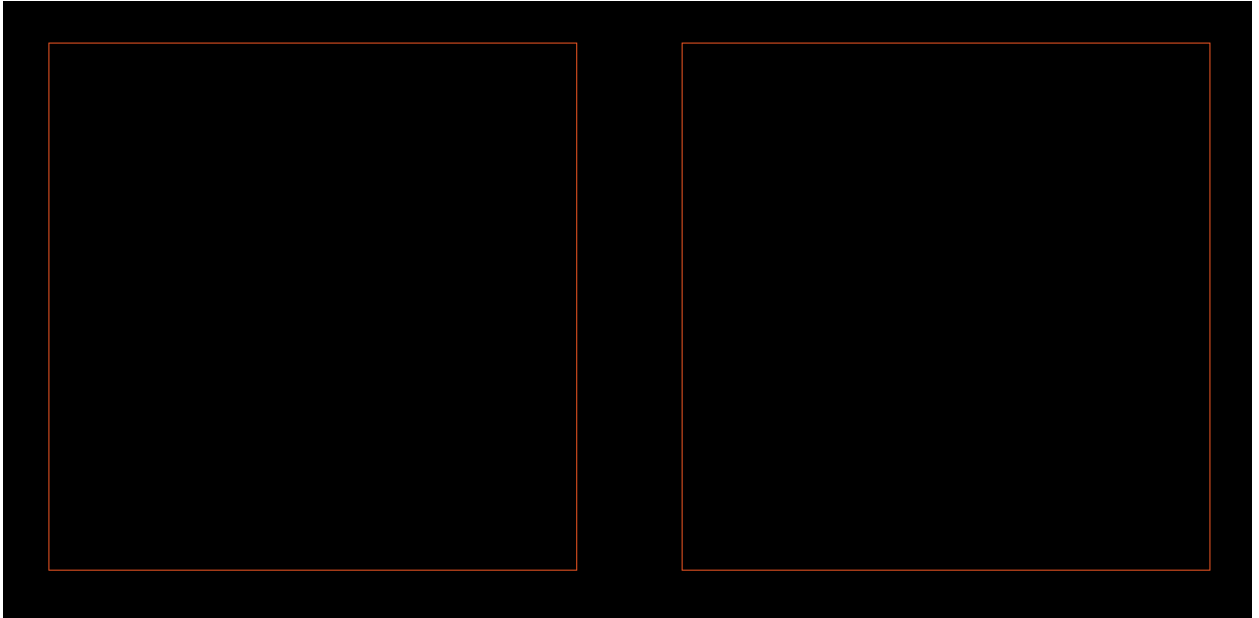

3. Example: two square boxes

Syntax	Annotation
G04 Ucamco ex. 1: Two square boxes*	A comment
%MOMM*%	Unit set to mm
%FSLAX26Y26*%	Format specification: Leading zeros omitted Absolute coordinates Coordinates in 2 integer and 6 fractional digits.
%TF.Part,Other,example*%	Attribute: the file does not describe a PCB part - it is just an example
%LPD*%	Set the polarity to dark
%ADD10C,0.010*%	Define aperture number 10 as a 0.01 mm circle
D10*	Select aperture 10 as current aperture
X0Y0D02*	Set current point to (0, 0)
G01*	Set linear plot mode
X5000000Y0D01*	Create draw graphical object with the current aperture (10): start point is the current point (0,0), end point is (5, 0)
Y5000000D01*	Create draw with the current aperture: (5, 0) to (5, 5)
X0D01*	Create draw with the current aperture: (5, 5) to (0, 5)

Syntax	Annotation
Y0D01*	Create draw with the current aperture: (0, 5) to (0, 0)
X6000000D02*	Set current point to (6, 0)
X11000000D01*	Create draw with the current aperture: (6, 0) to (11, 0)
Y5000000D01*	Create draw with the current aperture: (11, 0) to (11, 5)
X6000000D01*	Create draw with the current aperture: (11, 5) to (6, 5)
Y0D01*	Create draw with the current aperture: (6, 5) to (6, 0)
M02*	End of file

Syntax	Annotation
%AMTHERMAL80*	Define the aperture macro 'THERMAL80'
7,0,0,0.800,0.550,0.125,45*%	Use thermal primitive in the macro
%ADD10C,0.1*%	Define aperture 10 as a circle with diameter 0.1 mm
%ADD11C,0.6*%	Define aperture 11 as a circle with diameter 0.6 mm
%ADD12R,0.6X0.6*%	Define aperture 12 as a rectangle with size 0.6 x 0.6 mm
%ADD13R,0.4X1.00*%	Define aperture 13 as a rectangle with size 0.4 x 1 mm
%ADD14R,1.00X0.4*%	Define aperture 14 as a rectangle with size 1 x 0.4 mm
%ADD15O,0.4X01.00*%	Define aperture 15 as an obround with size 0.4 x 1 mm
%ADD16P,1.00X3*%	Define aperture 16 as a polygon with 3 vertices and circumscribed circle with diameter 1 mm
%ADD19THERMAL80*%	Define aperture 19 as an instance of macro aperture 'THERMAL80' defined earlier
G04 Start image generation*	A comment
D10*	Select aperture 10 as current aperture
X0Y2500000D02*	Set the current point to (0, 2.5) mm
G01*	Set linear plot mode
X0Y0D01*	Create draw with the current aperture
X2500000Y0D01*	Create draw with the current aperture
X10000000Y10000000D02*	Set the current point
X15000000D01*	Create draw with the current aperture
X20000000Y15000000D01*	Create draw with the current aperture
X25000000D02*	Set the current point.
Y10000000D01*	Create draw with the current aperture
D11*	Select aperture 11 as current aperture
X10000000Y10000000D03*	Create flash with the current aperture (11) at (10, 10).
X20000000D03*	Create a flash with the current aperture at (20, 10). Y is modal.
X25000000D03*	Create a flash with the current aperture at (25, 10). Y is modal.
Y15000000D03*	Create a flash with the current aperture at (25, 15). X is modal.
X20000000D03*	Create a flash with the current aperture at (20, 15). Y is modal.
D12*	Select aperture 12 as current aperture
X10000000Y15000000D03*	Create a flash with the current aperture at (10, 15)
D13*	Select aperture 13 as current aperture

Syntax	Annotation
X30000000Y15000000D03*	Create a flash with the current aperture at (30, 15)
D14*	Select aperture 14 as current aperture
Y12500000D03*	Create a flash with the current aperture at (30, 125)
D15*	Select aperture 15 as current aperture
Y10000000D03*	Create a flash with the current aperture at (30, 10)
D10*	Select aperture 10 as current aperture
X37500000Y10000000D02*	Set the current point
G75*	Must be called before an arc is created
G03*	Set counterclockwise circular plot mode
X37500000Y10000000I2500000J0D01*	Create full circular arc with the current aperture (10).
D16*	Set the current aperture: use aperture 16
X34000000Y10000000D03*	Create a flash with the current aperture 16
X35000000Y90000000D03*	Create a flash with the current aperture 16 again
G36*	Start a region statement
X50000000Y20000000D02*	Set the current point to (5, 20)
G01*	Set linear plot mode
Y37500000D01*	Create linear segment of the contour
X37500000D01*	Create linear segment of the contour
Y20000000D01*	Create linear segment of the contour
X50000000D01*	Create linear segment of the contour
G37*	Close the region statement. This creates the region by filling the created contour
%LPC*%	Set the polarity to clear
G36*	Start the region statement
X10000000Y25000000D02*	Set the current point to (10, 25)
Y30000000D01*	Create linear segment
G02*	Set clockwise circular plot mode
X12500000Y32500000I2500000J0D01*	Create clockwise circular segment with radius 2.5
G01*	Set linear plot mode
X30000000D01*	Create linear segment
G02*	Set clockwise circular plot mode
X30000000Y25000000I0J-3750000D01*	Create clockwise circular segment with radius 3.75
G01*	Set linear plot mode
X10000000D01*	Create linear segment

Syntax	Annotation
G37*	Close the region statement, creates region object
%LPD*%	Set the polarity to dark
D10*	Select aperture 10 as current aperture
X15000000Y28750000D02*	Set the current point
X20000000D01*	Create draw with the current aperture
D11*	Select aperture 11 as current aperture
X15000000Y28750000D03*	Create a flash with the current aperture (11)
X20000000D03*	Create a flash with the current aperture
D19*	Select aperture 19 as current aperture
X28750000Y28750000D03*	Create a flash with the current aperture (19)
M02*	End of file

2.12 Conformance

A file violating any requirement of the specification or containing constructs not defined in it is wholly invalid. An invalid Gerber file is meaningless and does *not* represent an image.

A conforming Gerber file writer must write files according to this specification. A current conforming Gerber file writer cannot use deprecated constructs. A writer is not required to consider limitations or errors in particular readers but may assume that a valid file will be processed correctly.

A conforming Gerber file reader must render a valid Gerber file according to this specification. A current reader may support deprecated format elements as they can be present in legacy files. To prepare for future extensions of the format, a Gerber file reader *must* give a warning when encountering an unimplemented command, skip it and continue processing. Otherwise there is *no* mandatory behavior on reading an invalid Gerber file. It is *not* mandatory to report any other errors – this would impose an unreasonable burden on readers and may result in useless messages in some applications. A reader is allowed to attempt to reverse engineer the intended image and display it. If reverse engineering fails the responsibility lies solely with the writer of the file, not with the reader – it is the file that is wrong, not the reader, as an invalid file is meaningless.

The responsibilities are obvious and plain. Writers must write valid and numerically robust files and readers must process such files correctly. Writers are not responsible to navigate around problems in the readers, nor are readers responsible to solve problems in the writers. Keep in mind Postel's rule: "*Be conservative in what you send, be liberal in what you accept.*"

Standard Gerber (RS-274-D) is revoked and therefore non-conforming. The responsibility for misunderstandings of its non-standardized wheel file rests solely with the party that decided to use Standard Gerber rather than Extended Gerber. See 8.5.

This document is the sole specification of the Gerber format. Gerber viewers, however useful, do not overrule this document.

3 Syntax

3.1 Character Set

A Gerber file is expressed in UTF-8 Unicode. The new line characters CR and LF are allowed after an asterix '*', a percentage '%' or a comma ','. They do not affect the interpretation of the file, but please use them for human readability. The Gerber file is therefore human-readable and transferable between systems.

The characters '*' and '%' are delimiters and can only be used as prescribed in the syntax. Space characters are *only* allowed inside strings and fields (see 3.4.3 and 3.4.4).

Gerber files are case-sensitive. Command codes must be in upper case.

Actually, *except for user defined attribute values*, all characters in a Gerber file are restricted to the readable ASCII characters, with codes 32 to 126, and new line characters. User defined meta-data may require special characters such as µ or may be in other languages than English; hence UTF-8 Unicode is allowed.

3.2 Formal Grammar

The formal grammar used in this specification is the parsing expression grammar (PEG), similar in formalism to context-free grammars, with a somewhat different interpretation. See https://en.wikipedia.org/wiki/Parsing_expression_grammar for more information. The grammar of is expressed in the variant of the Extended Backus-Naur Form used by the TatSu PEG parser generator. <https://tatsu.readthedocs.io/en/stable/> for more information. Only a subset of the rules in the very powerful TatSu grammar is needed – after all Gerber is a simple format. Below is a description of that subset, taken from the TatSu documentation.

A grammar consists of a sequence of one or more rules of the form:

name = <expression> ;

The expressions are constructed from the following operators, in reverse order of precedence.

Grammar Syntax Rules		
Rule	Name	Description
#	Comment	Comments have no effect on the grammar.
e1 e2	Choice	Match either e1 or e2 A can be used before the first option as a layout aid: rule = option1 option2 option3 ;
(e)	Grouping	Match e , making it a node in the syntax tree
[e]	Option	Optionally match e
{e} or {e}*	Closure	Match e zero or more times.
{e}+	Positive closure	Match e one or more times.
&e	Positive lookahead	Succeeds if e can be parsed. Does not consume input
!e	Negative lookahead	Fails if e can be parsed. Does not consume input
~	Cut	Commit to this alternative if the expressions to the left of the ~ match the input. The parse fails if the expressions to the right do not match.
'text'	Token	Match the token <i>text</i> . If <i>text</i> is alphanumeric it will only parse if the character following the token is not alphanumeric. This is done to prevent tokens like <i>IN</i> matching when the text ahead is <i>INITIALIZE</i> . This feature can be turned off by setting the grammar directive @nameguard=False
/regexp/	Regex	The pattern expression. Match the regular expression regexp at the current text position. Python style regex is used, and it is interpreted as a Python raw string.
\$	End-of-text	Verify that the end of the input text has been reached.

```
1, 0, $4, $2, $3*  
%  
%ADD11Donut, 0.30X0X0*%  
%ADD10C, 0.1*%  
G75*  
G02*  
D10*  
X0Y0D02*  
X2000000Y0I1000000J0D01*  
D11*  
X0Y2000000D03*  
M02*
```

One of the strengths of the Gerber format is its human readability. Use line breaks to enhance readability; put one word or command per line.

3.4 Data Types

All data types are tokens in the Gerber syntax, expressed a regex.

3.4.1 Integers

Integers must fit in a 32-bit signed integer. Examples:

```
0
-1024
+16
```

```
integer          = /[+-]?[0-9]+/;
unsigned_integer = /[0-9]+/;
positive_integer = /[0-9]*[1-9][0-9]*/;
```

3.4.2 Decimals

Decimals must fit in an IEEE double. Examples:

```
-200
5000
1234.56
.123
-0.128
0
```

```
decimal          = /[+-]?((( [0-9]+ ) ( \. [0-9]* ) ? ) | ( \. [0-9]+ ) ) /;
unsigned_decimal = /((( [0-9]+ ) ( \. [0-9]* ) ? ) | ( \. [0-9]+ ) ) /;
```

Note that a standalone comma ',' is *not* a valid decimal point.

3.4.3 Strings

Strings are used for communication between humans and can contain other characters than ASCII. These are expressed by UTF-8 literal characters, or by a Unicode escape. Note that reserved characters *must* be escaped.

string = /^[^%]*\$/; # All characters except %

Note that UTF-8 is identical to ASCII for any character that can be represented by ASCII.

The Unicode escape for the copyright symbol '©' is as follows:

- With lower case u for a 16-bit hex value: \- With upper case U for a 32-bit hex value: \

Zero-fill if needed to reach the required 4 or 8 hex digits

- The reserved characters '%' (\u0025) and '*' (\u002A) must *always* be escaped as they are the delimiters of the Gerber syntax.
- '\' (\u005C) must be escaped as it is the escape character.
- ',' (\u002C) separates fields, and therefore must be escaped in any string that does not end the word.

Any character may be escaped. Escape every non-ASCII character if you need to keep a file ASCII-only. This may increase compatibility with legacy software but defeats human readability of the meta-data.

If you want to keep the Gerber file printable ASCII-only use escape sequences for any character in strings or fields. This may increase compatibility with legacy software but defeats human readability of the meta-data.

3.4.4 Fields

The fields follow the string syntax in section 3.4.3 with the additional restriction that a field must not contain commas. Fields are intended to represent comma-separated items in strings. A comma can be escaped with \u002C.

field = /[\%*,]*;/ # All characters except %,

3.4.5 Names

Names identify something, such as an attribute. They are for use within the Gerber file only and are therefore limited to printable ASCII. See regex definition below

User defined names *cannot* begin with a dot. Names beginning with a dot are reserved for *standard names* defined in the specification.

```
name          = standard_name | user_name;  
user_name     = /[_a-zA-Z$][_a-zA-Z0-9]*/;  
standard_name = /\.[_a-zA-Z$][_a-zA-Z0-9]*/;
```

Note that user defined names, and standard names after their start dot, can start with a dollar, but cannot contain dollar elsewhere, and cannot start with a digit.

The scope of a name is from its definition till the end of the file. Names are case-sensitive.

Names for macro variables used in AM commands are more restrictive. They are of the form \$n, with n a positive integer, for example \$3.

3.5 Grammar of the Gerber Layer Format

```
@@grammar      :: Gerber_2022.02
@@nameguard    :: False
@@whitespace   :: /\n/
```

```
start =
  {
    | G04
    | MO
    | FS
    | AD
    | AM
    | Dnn
    | G75
    | G01
    | G02
    | G03
    | D01
    | D02
    | D03
    | LP
    | LM
    | LR
    | LS
    | region_statement
    | AB_statement
    | SR_statement
    | TF
    | TA
    | TO
    | TD
  }*
M02
$;
```

```

# Graphics commands
#-----

G04 = 'G04' string '*';

MO = '%MO' ('MM'|'IN') '*%';
FS = '%FS' 'LA' 'X' coordinate_digits 'Y' coordinate_digits '*%';
coordinate_digits = /[1-6][6]/;

G01 = 'G01*';
G02 = 'G02*';
G03 = 'G03*';
G75 = 'G75*';

AD = '%AD'
    aperture_identifer
    (
        | 'C' ',' ~ decimal ['X' decimal]
        | 'R' ',' ~ decimal 'X' decimal ['X' decimal]
        | 'O' ',' ~ decimal 'X' decimal ['X' decimal]
        | 'P' ',' ~ decimal 'X' decimal ['X' decimal ['X' decimal]]
        | name [',' decimal {'X' decimal}*]
    )
    '*%';

AM = '%AM' name '*' macro_body '%';
macro_body = { primitive | variable_definition }+;
variable_definition = macro_variable '=' expr '*';
primitive =
    | '0' string '*'
    | '1' ',' expr ',' expr ',' expr ',' expr [' ',' expr] '*'
    | '20' ',' expr ',' expr ',' expr ',' expr ',' expr ',' expr ','
    expr '*'
    | '21' ',' expr ',' expr ',' expr ',' expr ',' expr ',' expr '*'
    | '4' ',' expr ',' expr ',' expr ',' expr {' ',' expr ',' expr }+ ','
    expr '*'
    | '5' ',' expr ',' expr ',' expr ',' expr ',' expr ',' expr '*'
    | '7' ',' expr ',' expr ',' expr ',' expr ',' expr ',' expr '*'
    ;
macro_variable = /\$[0-9]*[1-9][0-9]*/;
expr =
    | {/[+ -]/ term}+
    | expr /[+ -]/ term
    | term
    ;
term =
    | term /[x\]/ factor
    | factor
    ;
factor =

```

```
| '(' ~ expr ')'  
| macro_variable  
| unsigned_decimal  
;
```

```
Dnn = aperture_identifler '*';
```

```
D01 = ['X' integer] ['Y' integer] ['I' integer 'J' integer] 'D01*';
```

```
D02 = ['X' integer] ['Y' integer] 'D02*';
```

```
D03 = ['X' integer] ['Y' integer] 'D03*';
```

```
LP = '%LP' ('C'|'D') '*%';
```

```
LM = '%LM' ('N'|'XY'|'Y'|'X') '*%';
```

```
LR = '%LR' decimal '*%';
```

```
LS = '%LS' decimal '*%';
```

```
M02 = 'M02*';
```



```

# Attribute commands
#-----
attribute_value = field {',' field}*;
TF = '%TF' file_attribute_name [',' attribute_value] '%%';
TA = '%TA' aperture_attribute_name [',' attribute_value] '%%';
TO = '%TO' object_attribute_name [',' attribute_value] '%%';
TD = '%TD'
    [
        | file_attribute_name
        | aperture_attribute_name
        | object_attribute_name
    ] '%%';

file_attribute_name =
    | '.Part'
    | '.FileFunction'
    | '.FilePolarity'
    | '.SameCoordinates'
    | '.CreationDate'
    | '.GenerationSoftware'
    | '.ProjectId'
    | '.MD5'
    | user_name
;

aperture_attribute_name =
    | '.AperFunction'
    | '.DrillTolerance'
    | '.FlashText'
    | user_name
;

object_attribute_name =
    | '.N'
    | '.P'
    | '.C' &',' # To prevent this rule from parsing .CRot etc.
    | '.CRot'
    | '.CMfr'
    | '.CMPN'
    | '.CVaI'
    | '.CMnt'
    | '.CFtp'
    | '.CPgN'
    | '.CPgD'
    | '.CHgt'
    | '.CLbN'
    | '.CLbD'
    | '.CSup'
    | user_name
;

```

Tokens, by regex

#-----

unsigned_integer = /[0-9]+/;

positive_integer = /[0-9]*[1-9][0-9]*/;

integer = /[+-]?[0-9]+/;

unsigned_decimal = /(((0-9+)(\.[0-9]*)?)|(\.[0-9+]))/;

decimal = /[+-]?(((0-9+)(\.[0-9]*)?)|(\.[0-9+]))/;

aperture_identifier = /D[0]*[1-9][0-9]+/;

name = standard_name | user_name;

user_name = /[_a-zA-Z\$][_a-zA-Z0-9]*/; # Cannot start with a dot

standard_name = /\.[_a-zA-Z\$][_a-zA-Z0-9]*/;

string = /[\^%]**/; # All characters except * %

field = /[\^%,]**/; # All characters except * % ,

3.6 File Extension, MIME Type and UTI

The Gerber Format has a standard file name extension, a registered mime type and a UTI definition.

Standard file extension: .gbr or .GBR

Mime type: application/vnd.gerber

(see <http://www.iana.org/assignments/media-types/application/vnd.gerber>)

Mac OS X UTI:

```
<key>UTExportedTypeDeclarations</key>
<array>
  <dict>
    <key>UTTypeIdentifier</key>
    <string>com.ucamco.gerber.image</string>
    <key>UTTypeReferenceURL</key>
    <string>http://www.ucamco.com/gerber</string>
    <key>UTTypeDescription</key>
    <string>Gerber image</string>
    <key>UTTypeConformsTo</key>
    <array>
      <string>public.plain-text</string>
      <string>public.image</string>
    </array>
    <key>UTTypeTagSpecification</key>
    <dict>
      <key>public.filename-extension</key>
      <array>
        <string>gbr</string>
      </array>
      <key>public.mime-type</key>
      <string>application/vnd.gerber</string>
    </dict>
  </dict>
</array>
```

4 Graphics

4.1 Comment (G04)

The G04 command is used for human readable comments. It does not affect the image.

The syntax for G04 is as follows.

```
G04 = ('G04' string) '*';
```

The string must follow the string syntax in 3.4.3.



Example:

```
G04 This is a comment*
```

```
G04 The space characters as well as \, ' and \;' are allowed here.*
```

Content starting with "**#@!**" is reserved for *standard comments*. The purpose of standard comments is to add meta-information in a formally defined manner, without affecting image generation. They can only be used if defined in this specification.

4.2 Coordinate Commands

The Gerber Layer Format uses 2D Cartesian coordinates. When the PCB is viewed from the top towards the bottom layer the X axis points to the right then the Y axis points upwards as in the illustration below.

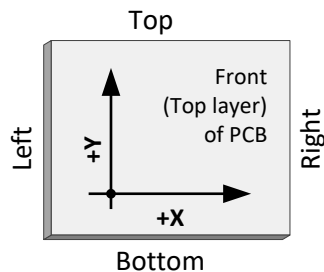

The origin of the system and its orientation can be chosen freely, but it is recommended to put the origin on the bottom left corner of the PCB and orient the X-axis along the bottom edge whenever possible. The same coordinate system *must* be used for all layers, in other words, objects on different layers that align in the real world *must* have the same coordinates. See illustration.

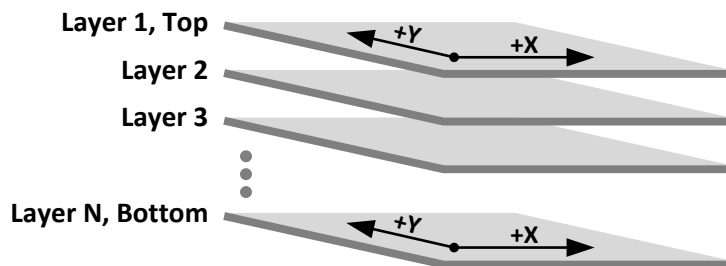

Positive rotation is counterclockwise when viewed from the top looking to the bottom layer.



4.2.1 Unit (MO)

The MO (Mode) command sets the file unit to either metric (mm) or imperial (inch).

The MO command must be used once and only once, in the header of the file, before the first operation command. The syntax is:

MO = '%' ('MO' ('MM'|'IN')) '*%';

Syntax	Comments
MO	MO for Mode
MM IN	MM – metric (millimeter) IN – imperial (inch)



Example:

```
G04 Defines aperture 10 as a circle with diameter 0.25mm*
%MOMM*%
...
%ADD10C,0.25*%
```

Use metric. Imperial is historical and will be deprecated at a future date.

4.2.2 Format Specification (FS)

Coordinate data represents the X, Y, I and J coordinates or distances in the operation commands (plot, move, flash). Coordinate data is in fixed format decimals, expressed in the unit set by the MO command. Leading zeros may be omitted.

The Format Specification specifies the number of integer and decimal places to expect in the coordinate data. The FS command must be used *once and only once*, in the header, before the first operation command. Its syntax is:

```
FS = '%' ('FS' 'LA' 'X' coord_digits 'Y' coord_digits) '*%';
coord_digits = /[1-6][6]/;
```

Syntax	Comments
FS	FS for Format Specification
LA	These mandatory characters are needed for compatibility with previous format versions, see 8.2.1.
coord_digits	<p>Specifies the number of integer and decimal digits in the coordinate data. See 4.8.</p> <p>The first digit sets the maximum number of integer digits. It can range from 1 up to 6; use a number that is sufficient for the size of the image; 3 is typical.</p> <p>The second digit sets the number of decimal digits decimal point. It must now be set to 6. (Previous format versions allowed other values.)</p> <p>The digits for X and for Y <i>must</i> be the same. (This unusual syntax is there for compatibility with previous versions of the format).</p>



Example:

```
%MOMM*%
```

```
%FSLAX36Y36*%
```

The file unit is mm. To interpret a coordinate, it is first left padded with zeros till it has 3+6 digits. The decimal point is then positioned before the 6th digit starting from the right. There are then 6 decimal digits. The resolution of the file 10-6mm, or 1 nm. The coordinate X123123456 means X at 123.123456mm, Y23456 means Y at .023456mm.

4.3 Aperture Definition (AD)

4.3.1 AD Command

The AD command creates an aperture, attaches the aperture attributes at that moment in the attribute dictionary to it and adds it to the apertures dictionary.

The syntax for the AD command is as follows:

```
AD = '%' ('AD' aperture_ident template_call) '*%';
template_call = template_name [',' parameter {'X' parameter}*];
```

Syntax	Comments
AD	'AD' is the command code
aperture_ident	The aperture identification being defined (≥ 10). The aperture numbers can range from 10 up to 2.147.483.647 (max int 32). The D00 to D09 are reserved and cannot be used for apertures. Once an aperture number is assigned it cannot be re-assigned – thus apertures are uniquely identified by their number.
template_call	Set the shape of the aperture by calling a template with actual parameters
template_name	The name of the template, either a standard aperture or macro (see 2.2). It follows the syntax of names (see 3.4.5).
[',' parameter {'X' parameters}*];	The number and meaning of the actual parameters depend on the template. Parameters are decimals. All sizes are in the unit of the MO command.

The AD command must precede the first use of the aperture. It is recommended to put all AD commands in the file header.



Example:

```
%ADD10C, .025*%
%ADD10C, 0.5X0.25*%
```

Section 5.8 has examples to illustrate how to attach aperture attributes to an aperture.

4.3.2 Examples

Syntax	Comments
<code>%ADD10C,0.025*%</code>	Create aperture with number 10: a solid circle with diameter 0.025
<code>%ADD22R,0.050X0.050X0.027*%</code>	Creates aperture 22: a rectangle with sides of 0.05 – therefore forming a square - and with a 0.027 diameter round hole
<code>%ADD57O,0.030X0.040X0.0015*%</code>	Creates aperture 57: an obround with sizes 0.03 x 0.04 with 0.015 diameter round hole
<code>%ADD30P,0.016X6*%</code>	Creates aperture 30: a solid polygon with 0.016 outer diameter and 6 vertices
<code>%ADD15CIRC*%</code>	Creates aperture 15: instantiate the macro aperture template CIRC defined previously with an aperture macro (AM) command

4.3.3 Zero-size Apertures

C (circular) standard apertures with zero diameter are allowed, and so are zero-size objects created with it. Attributes can be attached to such apertures and objects. Zero-size objects do not affect the image, but they can be used to indicate locations in the image plane, such as a board outline, and attach meta-information to these locations.



Warning: Zero-size apertures are *only* allowed with C apertures.

Use zero-size apertures sparingly. When tempted to use a zero-size object, consider whether it is useful, and whether there is no proper way to convey the meta-information.

Do not abuse zero-size objects to indicate the *absence* of an object, e.g. by flashing a zero-size aperture to indicate the absence of a pad; this is just confusing; if there is nothing, put nothing.

4.4 Standard Aperture Templates

4.4.1 Overview

Standard Aperture Templates			
Name	Shape	Parameters	Ref.
C	Circle	Diameter[, Hole diameter]	4.4.2
R	Rectangle	X size, Y size[, Hole diameter]	4.4.3
O	Obround	X size, Y size[, Hole diameter]	4.4.4
P	Polygon	Outer diameter, # vertices[, Rotation[, Hole diameter]]	4.4.5

Table with standard aperture templates

An aperture has an *origin*. When an aperture is flashed, its origin is positioned at the coordinates in the flash command (see 4.8.4). The origin of a standard aperture is its geometric center.

4.4.2 Circle

The syntax of the circle standard template call is:

```
template_call = 'C' ' , ' diameter ['X' hole_diameter];
```

Syntax	Comments
C	Indicate the circle aperture template.
diameter	Diameter. A decimal ≥ 0 .
hole_diameter	Diameter of a round hole. A decimal > 0 . If omitted the aperture is solid. See also section 4.4.6.



Examples:

```
%ADD10C, 0.5*%
```

```
%ADD10C, 0.5X0.25*%
```

These commands define the following apertures:

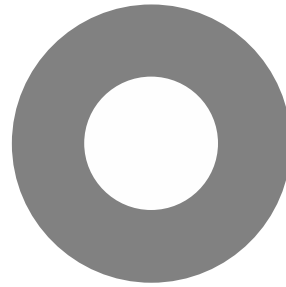
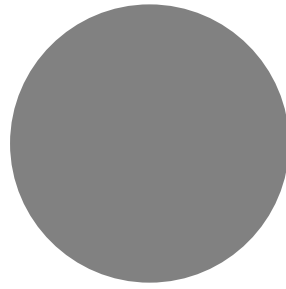

5. Circles

4.4.3 Rectangle

The syntax of the rectangle or square standard template call is:

```
template_call = 'R' ' ',' x_size 'X' y_size ['X' hole_diameter];
```

Syntax	Comments
R	Indicate the rectangle aperture template.
x_size y_size	X and Y sizes of the rectangle. Decimals >0. If x_size = y_size the effective shape is a square.
hole_diameter	Diameter of a round hole. A decimal >0. If omitted the aperture is solid. See also section 4.4.6.



Examples:

```
%ADD22R,0.044X0.025*%
```

```
%ADD23R,0.044X0.025X0.019*%
```

These commands define the following apertures:

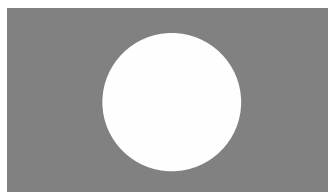

6. Rectangles

4.4.4 Obround

Obround (oval) is a rectangle where the smallest side is rounded to a half-circle. The syntax is:

```
template_call = 'O' ' ,' x_size 'X' y_size ['X' hole_diameter];
```

Syntax	Comments
O	Indicates the obround aperture template.
x_size y_size	X and Y sizes of enclosing box. Decimals >0. If x_size = y_size the effective shape is a circle.
hole_diameter	Diameter of a round hole. A decimal >0. If omitted the aperture is solid. See also section 4.4.6.



Example:

```
%ADD220,0.046X0.026*%
```

```
%ADD220,0.046X0.026X0.019*%
```

These commands define the following apertures:

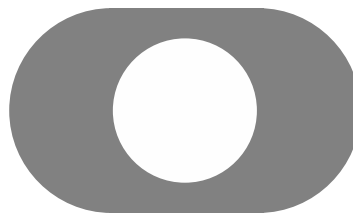
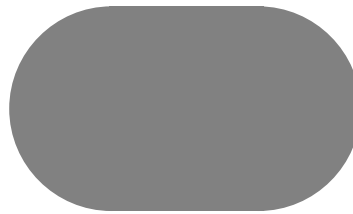

7. Obrounds

4.4.5 Polygon

Creates a *regular* polygon aperture. The syntax of the polygon template is:

```
template_call = 'P' ',' outer_diameter 'X' vertices
               ['X' rotation ['X' hole_diameter]];
```

Syntax	Comments
P	Indicates the polygon aperture template.
outer_diameter	Diameter of the circle circumscribing the regular polygon, i.e. the circle through the polygon vertices. A decimal > 0.
vertices	Number of vertices n, $3 \leq n \leq 12$. An integer.
rotation	The rotation angle, in degrees counterclockwise. A decimal. With rotation angle zero there is a vertex on the positive X-axis through the aperture center.
hole_diameter	Diameter of a round hole. A decimal >0. If omitted the aperture is solid. See also section 4.4.6.



Examples:

```
%ADD17P, .040X6X0.0*%
```

```
%ADD17P, .040X6X0.0X0.019*%
```

These commands define the following apertures:

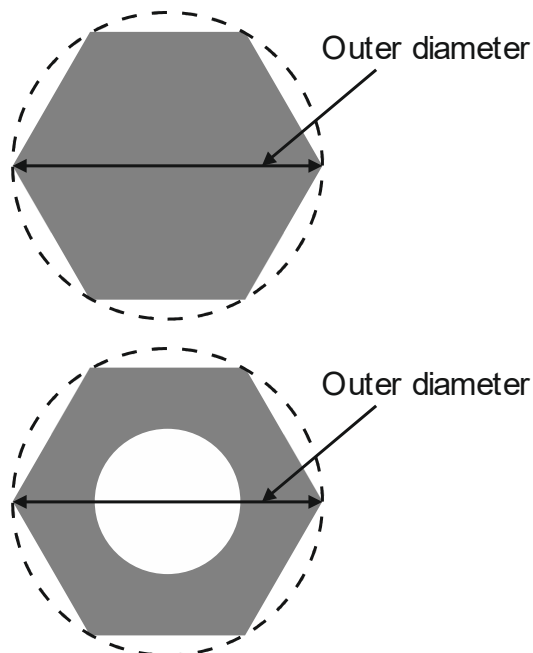

8. Polygons

4.4.6 Transparency of Holes

Standard apertures may have a round hole in them. When an aperture is flashed only the solid part affects the image, the hole does *not*. Objects under a hole remain visible through the hole. For image generation the area of the hole behaves exactly as the area outside the aperture. The hole is not part of the aperture.



Warning: Make no mistake: holes do *not* clear the objects under them.

For all standard apertures the round hole is defined by specifying its diameter as the last parameter: <Hole diameter>. If <Hole diameter> is omitted the aperture is solid. If present the diameter must be > 0. The hole must strictly fit within the standard aperture. It is centered on the aperture.



Example:

```
%FSLAX26Y26*%  
%MOMM*%  
%ADD10C,10X5*%  
%ADD11C,1*%  
G01*  
%LPD*%  
D11*  
X-9000000Y-2000000D02*  
X9000000Y2000000D01*  
D10*  
X0Y0D03*  
M02*
```



9. Standard (circle) aperture with a hole above a draw

Note that the draw is visible through the hole.

4.5 Aperture Macro (AM)

The AM command creates a macro aperture template and adds it to the aperture template dictionary (see 2.2). A template is a parametrized shape. The AD command instantiates a template into an aperture by supplying values to the template parameters.

Templates of any shape or parametrization can be created. Multiple simple shapes called primitives can be combined in a single template. The template is created by positioning primitives in a coordinate space. The origin of that coordinate space will be the origin of all apertures created with the state. An aperture macro can contain variables whose actual values are defined by:

- Values provided by the AD command
- Arithmetic expressions with other variables

The AM command can be used multiple times in a file. A template must be defined before the first AD that refers to it.

Attributes are *not* attached to templates. They are attached to the aperture at the time of its creation with the AD command.

An AM command contains the following words:

- The AM declaration with the macro name
- Primitives with their comma-separated parameters
- Macro variables, defined by an arithmetic expression

The syntax for the AM command is:

```
AM = '%' ('AM' macro_name macro_body) '%';
macro_name = name '*';
macro_body = {in_macro_block}+;
in_macro_block =
    |primitive
    |variable_definition
    ;
variable_definition = (macro_variable '=' expression) '*';
macro_variable = '$' positive_integer;
primitive = primitive_code {',' parameter}*;
parameter = expression;
```

Syntax	Comments
AM	AM for Aperture Macro
<Macro name>	Name of the aperture macro. The name must be unique. It cannot be the name of a standard aperture template, nor the name already used for another macro. See 3.4.5 for the syntax rules.
<Macro body>	The macro body contains the primitives generating the image and the calculation of their parameters.

Syntax	Comments
<Variable definition>	\$n=<Arithmetic expression>. An arithmetic expression may use arithmetic operators (described later), constants and variables \$m defined previously.
<Primitive>	A primitive is a basic shape to create the macro. It includes primitive code identifying the primitive and primitive-specific parameters (e.g. center of a circle). See 4.5.1. The primitives are positioned in a coordinate system whose origin will be the origin of the resulting apertures.
<Primitive code>	A code specifying the primitive (e.g. polygon).
<Parameter>	Parameter can be a decimal number (e.g. 0.050), a macro variable (e.g. \$1) or an arithmetic expression. The actual value is calculated as explained in 4.5.4.3.

Coordinates and sizes are expressed in the unit set by the MO command.

A macro variable name must be a '\$' character followed by an integer >0, for example \$12. (This is a subset of names allowed in 3.4.3.)



Note: New lines can be added between words of a single command to enhance readability. They do not affect the macro definition.



Example:

The following AM command defines an aperture macro named 'Triangle_30'.

```
%AMTriangle_30*
4,1,3,
1,-1,
1,1,
2,1,
1,-1,
30*
%
```

4.5.1 Primitives

4.5.1.1 Overview

Macro Primitives			
Code	Name	Parameters	Ref.
0	Comment	A comment string	4.5.1.2
1	Circle	Exposure, Diameter, Center X, Center Y[, Rotation]	4.5.1.3
20	Vector Line	Exposure, Width, Start X, Start Y, End X, End Y, Rotation	4.5.1.4
21	Center Line	Exposure, Width, Height, Center X, Center Y, Rotation	4.5.1.5
4	Outline	Exposure, # vertices, Start X, Start Y, Subsequent points..., Rotation	4.5.1.6
5	Polygon	Exposure, # vertices, Center X, Center Y, Diameter, Rotation	4.5.1.7
7	Thermal	Center X, Center Y, Outer diameter, Inner diameter, Gap, Rotation	4.5.1.8

Table with macro primitives

Except for the comment all the parameters can be a decimal, integer, macro variables or an arithmetic expression.

4.5.1.2 Comment, Code 0

The comment primitive has no effect on the image but adds human-readable comments in an AM command. The comment primitive starts with the '0' code followed by a space and then a single-line text string. The text string follows the syntax for strings in section 3.4.3.



Example:

```
%AMBox*  
0 Rectangle with rounded corners, with rotation*  
0 The origin of the aperture is its center*  
0 $1 X-size*  
0 $2 Y-size*  
0 $3 Rounding radius*  
0 $4 Rotation angle, in degrees counterclockwise*  
0 Add two overlapping rectangle primitives as box body*  
21,1,$1,$2-$3-$3,0,0,$4*  
21,1,$1-$3-$3,$2,0,0,$4*  
0 Add four circle primitives for the rounded corners*  
$5=$1/2*  
$6=$2/2*  
$7=2x$3*  
1,1,$7,$5-$3,$6-$3,$4*  
1,1,$7,-$5+$3,$6-$3,$4*  
1,1,$7,-$5+$3,-$6+$3,$4*  
1,1,$7,$5-$3,-$6+$3,$4*%
```

4.5.1.3 Circle, Code 1

A circle primitive is defined by its center point and diameter.

Parameter number	Description
1	Exposure off/on (0/1)
2	Diameter ≥ 0
3	Center X coordinate.
4	Center Y coordinate.
5	Rotation angle of the center, in degrees counterclockwise. The primitive is rotated around the origin of the macro definition, i.e. the (0, 0) point of macro coordinates. The rotation parameter is optional. The default is no rotation.

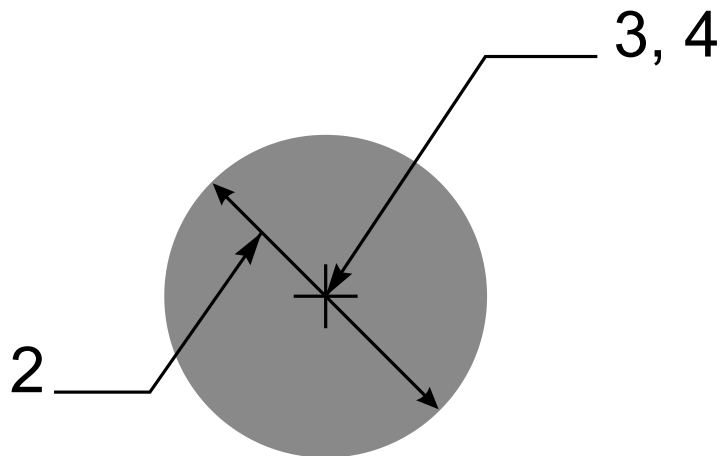

10. Circle primitive

Below there is the example of the AM command that uses the circle primitive.



Example:

```
%AMCircle*
1,1,1.5,0,0,0*%
```

4.5.1.4 Vector Line, Code 20.

A vector line is a rectangle defined by its line width, start and end points. The line ends are rectangular.

Parameter number	Description
1	Exposure off/on. (0/1)
2	Width of the line ≥ 0 .
3	Start point X coordinate.
4	Start point Y coordinate.
5	End point X coordinate.
6	End point Y coordinate.
7	Rotation angle, in degrees counterclockwise. The primitive is rotated around the origin of the macro definition, i.e. the (0, 0) point of macro coordinates

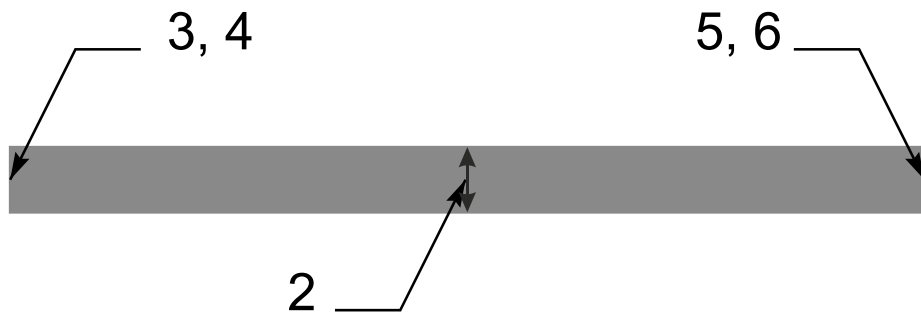

11. Vector line primitive

Below there is the example of the AM command that uses the vector line primitive.



Example:

```
%AMLine*
20,1,0.9,0,0.45,12,0.45,0*
%
```

4.5.1.5 Center Line, Code 21

A center line primitive is a rectangle defined by its width, height, and center point.

Parameter number	Description
1	Exposure off/on. (0/1)
2	Width ≥ 0 .
3	Height ≥ 0 .
4	Center point X coordinate.
5	Center point Y coordinate.
6	Rotation angle, in degrees counterclockwise. The primitive is rotated around the origin of the macro definition, i.e. (0, 0) point of macro coordinates. ⚠ Warning: The rotation is <i>not</i> around the center point. (Unless the center point happens to be the macro origin.)

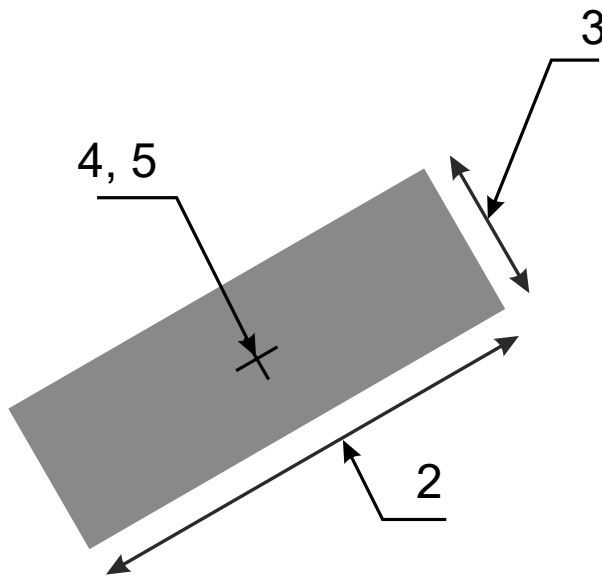

12. Center line primitive

Below there is the example of the AM command that uses the center line primitive.



Example:

```
%AMRECTANGLE*
21,1,6.8,1.2,3.4,0.6,30*%
```

4.5.1.6 Outline, Code 4

An outline primitive is an area defined by its outline or contour. The outline is a polygon, consisting of linear segments only defined by its start vertex and n subsequent vertices. The outline must be closed, i.e. the last vertex must be equal to the start vertex. The outline must comply with all the requirements of a contour according to 4.10.3.

Parameter number	Description
1	Exposure off/on (0/1)
2	The number of vertices of the outline = the number of coordinate pairs <i>minus one</i> . An integer ≥ 3 .
3, 4	Start point X and Y coordinates.
5, 6	First subsequent X and Y coordinates.
...	Further subsequent X and Y coordinates. The X and Y coordinates are <i>not</i> modal: both X <i>and</i> Y must be specified for all points.
3+2n, 4+2n	Last subsequent X and Y coordinates. As the outline must be closed the last coordinates <i>must</i> be equal to the start coordinates.
5+2n	Rotation angle, in degrees counterclockwise, a decimal. The primitive is rotated around the origin of the macro definition, i.e. the (0, 0) point of macro coordinates.

13. Outline primitive

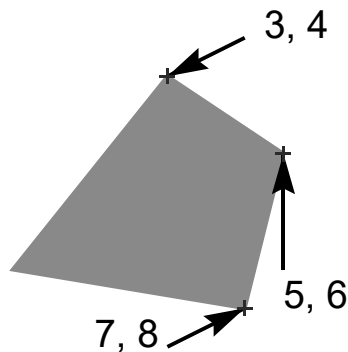

The maximum number of vertices is 5000. The purpose of this primitive is to create apertures to flash pads with special shapes. The purpose is not to create copper pours. Use the region statement for copper pours; see 4.10.

 **Example:**

The following AM command defines an aperture macro named 'Triangle_30'. The macro is a triangle rotated 30 degrees around the origin of the macro definition:

```
%AMTriangle_30*
4,1,3,
1,-1,
1,1,
2,1,
1,-1,
30*
%
```

Syntax	Comments
AM Triangle_30	Aperture macro name is 'Triangle_30'
4,1,3	4 – Outline 1 – Exposure on 3 – The outline has three subsequent points
1,-1	1 – X coordinate of the start point -1 – Y coordinate of the start point
1,1, 2,1, 1,-1,	Coordinates (X, Y) of the subsequent points: (1,1), (2,1), (1,-1). Note that the last point is the same as the start point
30	Rotation angle is 30 degrees counterclockwise

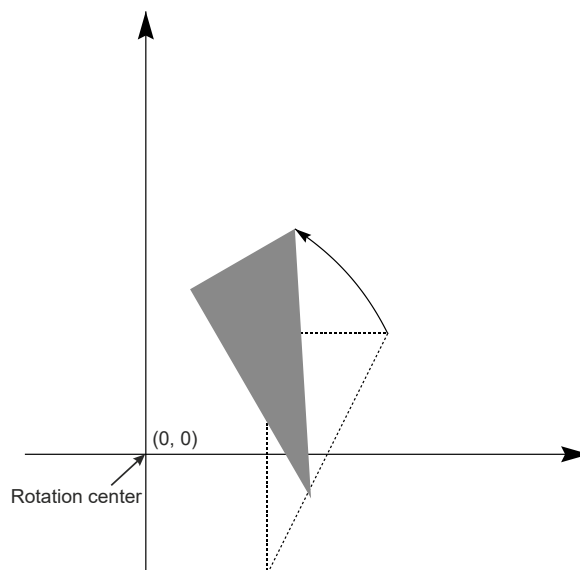

14. Rotated triangle

4.5.1.7 Polygon, Code 5

A polygon primitive is a regular polygon defined by the number of vertices n , the center point and the diameter of the circumscribed circle.

Parameter number	Description
1	Exposure off/on (0/1)
2	Number of vertices n , $3 \leq n \leq 12$. An integer. The first vertex is on the positive X-axis through the center point when the rotation angle is zero.
3	Center point X coordinate.
4	Center point Y coordinate.
5	Diameter of the circumscribed circle ≥ 0 .
6	Rotation angle, in degrees counterclockwise. With rotation angle zero there is a vertex on the positive X-axis through the aperture center. The primitive is rotated around the origin of the macro definition, i.e. the (0, 0) point of macro coordinates.

15. Polygon primitive

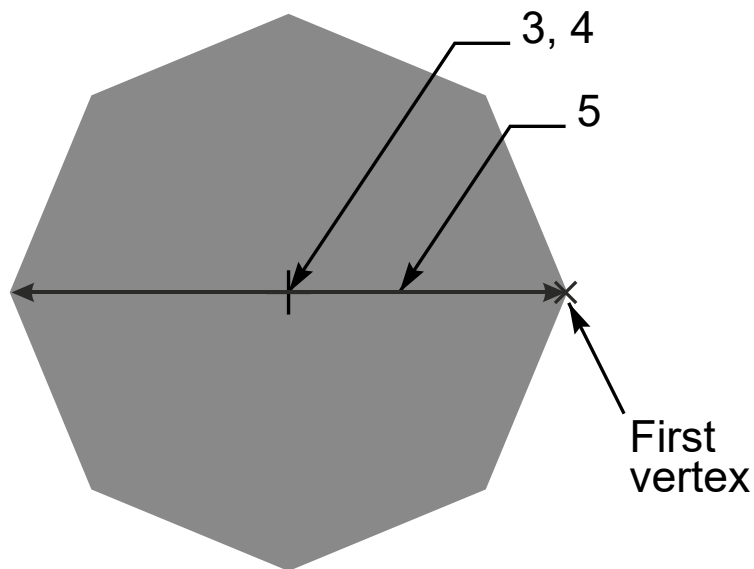

Example:

```
%AMPolygon*
5, 1, 8, 0, 0, 8, 0*%
```

4.5.1.8 Thermal, Code 7

The thermal primitive is a ring (annulus) interrupted by four gaps. Exposure is always on.

Parameter number	Description
1	Center point X coordinate.
2	Center point Y coordinate.
3	Outer diameter > inner diameter
4	Inner diameter ≥ 0
5	Gap thickness < (outer diameter)/ $\sqrt{2}$. Note that if the (gap thickness)* $\sqrt{2} \geq$ (inner diameter) the inner circle disappears. This is valid. The gaps are on the X and Y axes through the center without rotation. They rotate with the primitive.
6	Rotation angle, in degrees counterclockwise. A decimal. The primitive is rotated around the origin of the macro definition, i.e. (0, 0) point of macro coordinates.

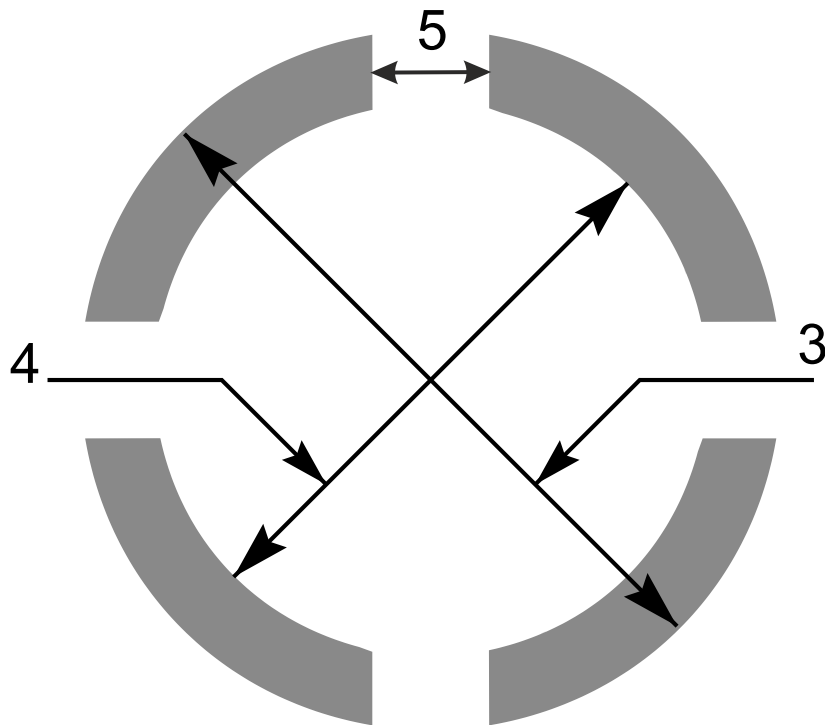

16. Thermal primitive



Example:

```
%AMThermal*
7,0,0,0.95,0.75,0.175,0.0*%
```

4.5.2 Exposure Parameter

The exposure parameter that can take two values:

- 0 means exposure is 'off'
- 1 means exposure is 'on'

Primitives with **exposure on** create the solid part of the macro aperture.

Primitives with **exposure off** erase the solid part created earlier *in the same macro*. Exposure off is used to create a hole in the aperture – see also 4.4.6. **Exposure off** only acts on primitives within the same macro definition. The hole does *not* clear objects in the final image. The hole is transparent. Objects under holes remain visible. A macro definition results in a strictly positive image.



Example:

```
%FSLAX26Y26*%
%MOMM*%
%AMSquareWithHole*
21,1,10,10,0,0,0*
1,0,5,0,0*%
%ADD10SquareWithHole*%
%ADD11C,1*%
G01*
%LPD*%
D11*
X-8000000Y-2000000D02*
X8000000Y2000000D01*
D10*
X0Y0D03*
M02*
```



17. Macro aperture with a hole above a draw

Note that the draw is still visible through the hole.

Revision 2026.05

- Copyright Ucamco NV

Having a question or remark about the spec? Please contact us at gerber@ucamco.com

4.5.3 Rotation Parameter

All primitives can be rotated around the *origin* of the macro definition, i.e. its point (0, 0). (Make no mistake: rotation is *not* around the geometric center of the primitive, unless of course it coincides with the origin.)

A rotation angle is expressed by a decimal number, in degrees counterclockwise. A positive angle means counterclockwise rotation, a negative angle clockwise. The rotation angle is defined by the rotation parameter, the last in the list of the primitive parameters.

To rotate a macro composed of several primitives it is sufficient to rotate all primitives by the same angle. See illustration below.

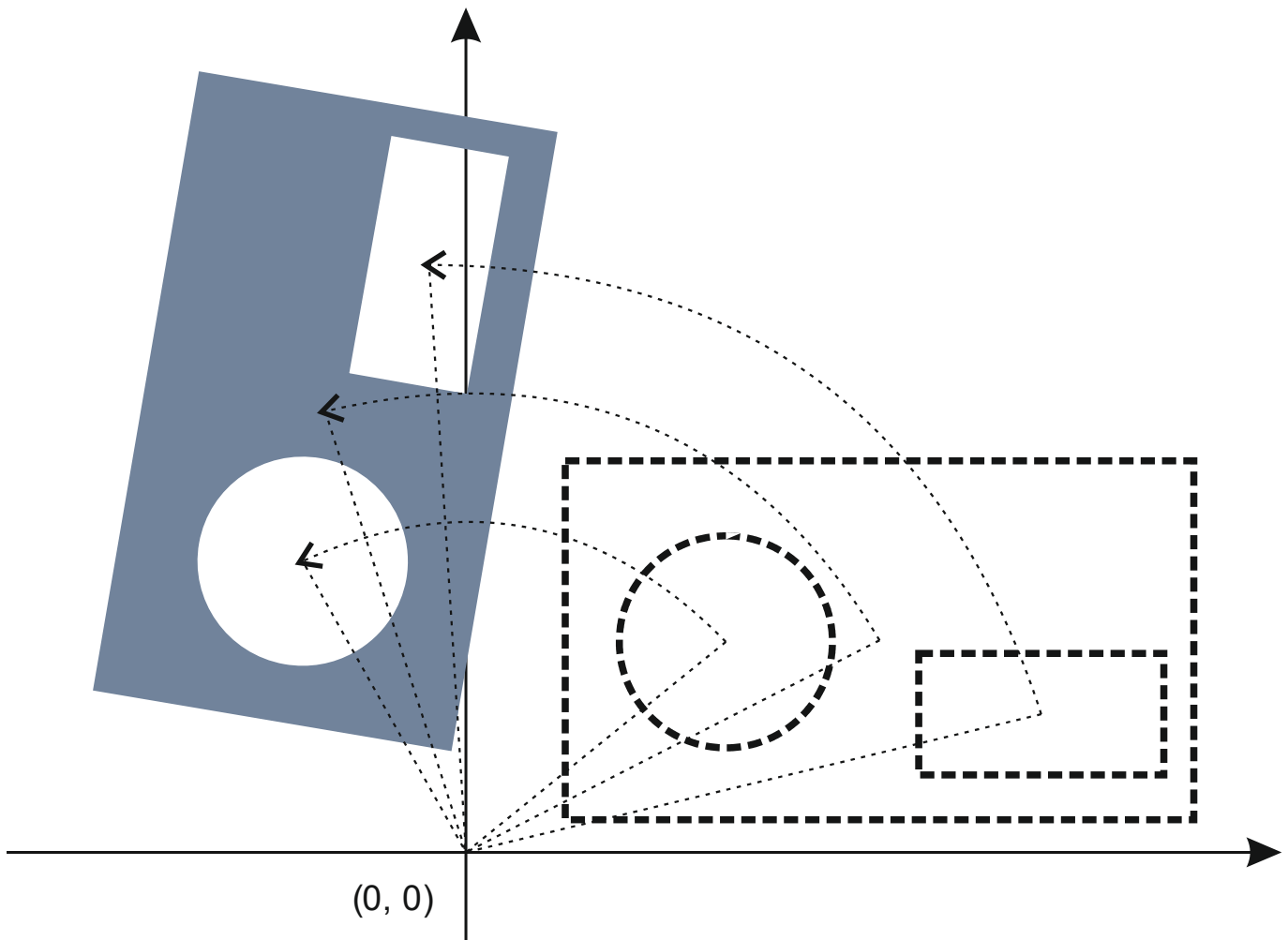

18. Rotation of an aperture macro composed of several primitives

Warning: Rotation is around the origin of the macro definition, not around the geometric center of the primitive – unless the two coincide of course. The reason is obvious: if rotation were about the center of each primitive a composite aperture like the one above would fall apart under rotation.

4.5.4 Macro Variables and Expressions

When an AD command calls a macro, the actual values of the parameters of the primitives are given by so-called macro variables, or arithmetic expressions thereof. Macro variable names are of the form \$n, with n a positive integer, for example \$3. Their values are set by

- the parameters of the AD command
- new variables, set by an arithmetic expression

4.5.4.1 Variables from the AD Command

The AD command calling the macro sets a number of macro variables. The variable ‘\$n’ is assigned to the nth value in the list of the variable values in the AD command. Thus \$1 means the first value in the list, \$2 the second, and so on.



Example:

Consider the following macro definition:

```
%AMDONUTVAR*
1, 1, $1, $2, $3*
1, 0, $4, $2, $3*%
```

When called with the following AD command

```
%ADD34DONUTVAR, 0.100X0X0X0.080*%
```

the variables \$1, \$2, \$3 and \$4 take the values:

```
$1 = 0.100
$2 = 0
$3 = 0
$4 = 0.080
```

4.5.4.2 Arithmetic Expressions and New variables

Macro variables can be combined in arithmetic expressions. Expressions can contain integer constants, decimal constants, and other variables. Arithmetic operations can be performed with the operators below. The standard operator precedence rules apply. Brackets ‘(, ’) can be used in the standard way.

Operator	Function
+	Unary plus (expressions without the unary sign are positive)
-	Unary minus
+	Add
-	Subtract
x (lower case)	Multiply
/	Divide. The result is a decimal; it is not rounded to an integer.

Arithmetic operators

 **Example:**

Here is an example of a macro definition using arithmetic expressions:

```
%AMRect*
21, 1, $1, $2-2x$3, -$4, -$5+$2, 0*%
```

An example of the corresponding AD command is:

```
%ADD146Rect, 0.0807087X0.1023622X0.0118110X0.5000000X0.3000000*%
```

New variables can be defined with an assign statement as follows: $\$4 = \$1 \times 1.25 - \$3$. The right-hand side is any arithmetic expression. The variable values are set as follows:

- \$1, \$2, ..., \$n take the values of the n parameters of the calling AD command.
- New variables get their value from their defining expression.
- Undefined variables are 0.
- Macro variables *cannot* be redefined. Attempts to redefine one results in an invalid file.

 **Example:**

```
%AMDONUTCAL*
1, 1, $1, $2, $3*
$5=$4x0.25*
1, 0, $5, $2, $3*%
%ADD35DONUTCAL, 0.020X0X0X0.06*%
```

The AD command contains four parameters which define the first four macro variables:

```
$1 = 0.02
$2 = 0
$3 = 0
$4 = 0.06
```

The variable \$5 is defined in the macro body and becomes

```
$5 = 0.06 x 0.25 = 0.015
```

Below are more examples to illustrate the syntax.

 **Examples:**

```
%AMTEST1*
1, 1, $1, $2, $3*
$4=$1x0.75*
$5=($2+100)x1.75*
1, 0, $4, $5, $3*%
```

```
%AMTEST2*
$4=$1x0.75*
$5=100+$3*
1, 1, $1, $2, $3*
1, 0, $4, $2, $5*
$6=$4x0.5*
1, 0, $6, $2, $5*%
```

4.5.5 Examples

4.5.5.1 Fixed Parameter Values

The following AM command defines an aperture macro named 'DONUTFIX' consisting of two concentric circles with fixed diameter sizes:

```
%AMDONUTFIX*
1,1,0.100,0,0*
1,0,0.080,0,0*
%
```

Syntax	Comments
AMDONUTFIX	Aperture macro name is 'DONUTFIX'
1,1,0.100,0,0	1 – Circle 1 – Exposure on 0.100 – Diameter 0 – X coordinate of the center 0 – Y coordinate of the center
1,0,0.080,0,0	1 – Circle 0 – Exposure off 0.080 – Diameter 0 – X coordinate of the center 0 – Y coordinate of the center

An example of an AD command using this aperture macro:

```
%ADD33DONUTFIX*%
```

4.5.5.2 Variable Parameter Values

The following AM command defines an aperture macro named 'DONUTVAR' consisting of two concentric circles with variable diameter sizes:

```
%AMDONUTVAR*
1,1,$1,$2,$3*
1,0,$4,$2,$3*%
```

Syntax	Comments
AMDONUTVAR	Aperture macro name is 'DONUTVAR'
1,1,\$1,\$2,\$3	1 – Circle 1 – Exposure on \$1 – Diameter is provided by AD command \$2 – X coordinate of the center is provided by AD command \$3 – Y coordinate of the center is provided by AD command

1,0,\$4,\$2,\$3	1 – Circle 0 – Exposure off \$4 – Diameter is provided by AD command \$2 – X coordinate of the center is provided by AD command (same as in first circle) \$3 – Y coordinate of the center is provided by AD command (same as in first circle)
-----------------	--

The AD command using this aperture macro can look like the following:

```
%ADD34DONUTVAR, 0.100X0X0X0.080*%
```

In this case the variable parameters get the following values: \$1 = 0.100, \$2 = 0, \$3 = 0, \$4 = 0.080.

4.5.5.3 Definition of a New Variable

The following AM command defines an aperture macro named 'DONUTCAL' consisting of two concentric circles with the diameter of the second circle defined as a function of the diameter of the first:

```
%AMDONUTCAL*  
1, 1, $1, $2, $3*  
$4=$1x0.75*  
1, 0, $4, $2, $3*%
```

Syntax	Comments
AMDONUTCAL	Aperture macro name is 'DONUTCAL'
1,1,\$1,\$2,\$3	1 – Circle 1 – Exposure on \$1 – Diameter is provided by AD command \$2 – X coordinate of the center is provided by AD command \$3 – Y coordinate of the center is provided by AD command
\$4=\$1x0.75	Defines variable \$4 to be used as the diameter of the inner circle; the diameter of this circle is 0.75 times the diameter of the outer circle
1,0,\$4,\$2,\$3	1 – Circle 0 – Exposure off \$4 – Diameter is calculated with the previous definition of this variable \$2 – X coordinate of the center is provided by AD command (same as in first circle) \$3 – Y coordinate of the center is provided by AD command (same as in first circle)

The AD command using this aperture macro can look like the following:

```
%ADD35DONUTCAL, 0.020X0X0*%
```

This defines a donut with outer circle diameter equal to 0.02 and inner circle diameter equal to 0.015.

4.5.5.4 A useful macro

The following example creates a rectangle with rounded corners, useful as SMD pad.

It uses the following construction:

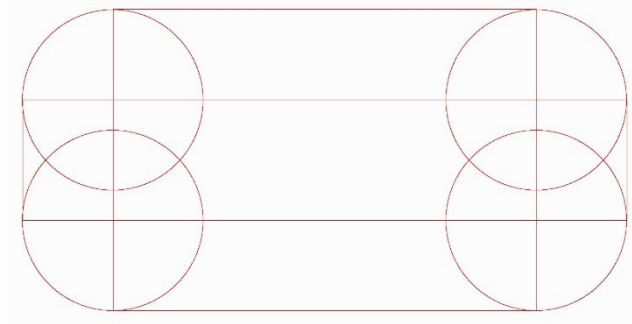

19. Construction of the Box macro

```
%AMBox*
0 Rectangle with rounded corners, with rotation*
0 The origin of the aperture is its center*
0 $1 X-size*
0 $2 Y-size*
0 $3 Rounding radius*
0 $4 Rotation angle, in degrees counterclockwise*
0 Add two overlapping rectangle primitives as box body*
21,1,$1,$2-$3-$3,0,0,$4*
21,1,$1-$3-$3,$2,0,0,$4*
0 Add four circle primitives for the rounded corners*
$5=$1/2*
$6=$2/2*
$7=2x$3*
1,1,$7,$5-$3,$6-$3,$4*
1,1,$7,-$5+$3,$6-$3,$4*
1,1,$7,-$5+$3,-$6+$3,$4*
1,1,$7,$5-$3,-$6+$3,$4*
%
```

4.6 Set Current Aperture (Dnn)

The command Dnn (nn≥10) sets the current aperture graphics state parameter. The syntax is:
Dnn = 'D' unsigned_integer '*';

Syntax	Comments
D	Command code
<aperture number>	The aperture number (integer ≥10). An aperture with that number must be in the apertures dictionary.

D-commands 0 to 9 are reserved and *cannot* be used for apertures. The D01 and D03 commands use the current aperture to create track and flash graphical objects.



Example:

D10*

4.7 Plot State Commands (G01,G02,G03,G75)

4.7.1 Linear Plotting (G01)

G01 sets linear plot mode. In linear plot mode a D01 operation generates a linear segment, from the current point to the (X, Y) coordinates in the command. The current point is then set to the (X, Y) coordinates.

Outside a region statement the segment is stroked with the current aperture to create a *draw graphical object*. Inside a region statement the segment is added to the contour under construction.

The G01 command sets linear operation. The syntax is as follows:

G01 = ('G01') '*' ;

Syntax	Comments
G01	Sets plot mode graphics state parameter to 'linear plotting

D01 = (['X' x_coordinate] ['Y' y_coordinate] 'D01') '*' ;

Syntax	Comments
x_coordinate	An integer specifying the X coordinate of the end point of the straight segment. The default is the X coordinate of the current point.
y_coordinate	As above, but for the Y axis.
D01	Plot operation code

The coordinates are interpreted as specified by the FS and MO command.



Example:

```
G01*
X250000Y155000D01*
```

4.7.2 Circular Plotting (G02, G03, G75)

G02 sets clockwise circular plot mode, G03 counterclockwise. In circular plot mode a D01 operation generates an arc segment, from the current point to the (X, Y) coordinates in the command. The current point is then set to the (X, Y) coordinates.

Outside a region statement the segment is stroked with the current aperture to create an *arc graphical object*. In a region statement the segment is added to the contour under construction.

For compatibility with older versions of the Gerber format, a G75* must be issued before the first D01 in circular mode.

The syntax of these commands is:

```
G02 = ('G02') '*';
G03 = ('G03') '*';
G75 = ('G75') '*';
```

Syntax	Comments
G02	Sets plot mode graphics state parameter to 'clockwise circular plotting'
G03	Sets plot mode graphics state parameter to 'counterclockwise circular plotting'
G75	This command must be issued before the first circular plotting operation, for compatibility with older Gerber versions



Examples:

```
G02*
G75*
```

The syntax of the D01 command in circular plot mode is:

```
D01 = (['X' x_coordinate] ['Y' y_coordinate] 'I' x_offset 'J' y_offset 'D01') '*';
```

Syntax	Comments
x_coordinate	x_coordinate
y_coordinate	As above, but for the Y axis.
x_offset	Add the I offset to the X coordinate of the start point of the arc to calculate the X of the center of the arcs. <Offset> is an integer.
y_offset	As above, but for the Y axis.
D01	Plot operation code

The coordinates and offsets are interpreted as specified by the FS and MO command.

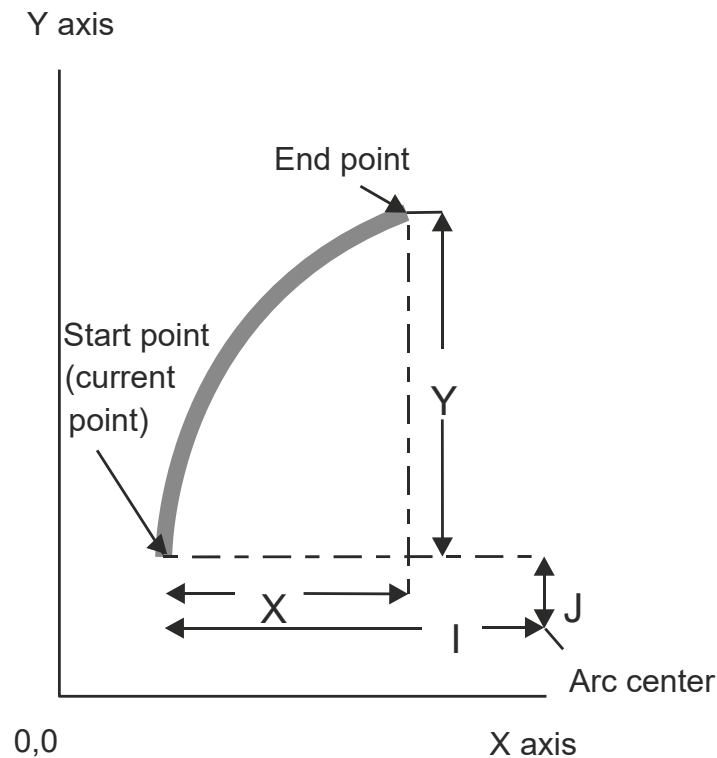

20. Circular plotting example



Example:

```
G75*
G03*
X75000Y50000I40000J0D01*
```

When start point and end point coincide the result is a full 360° arc. An example:

Syntax	Comments
D10*	Select aperture 10 as current aperture
G01*	Set linear plot mode
X0Y6000000D2*	Set the current point to (0, 6)
G75*	Must be called before an arc is created.
G02*	Set clockwise circular plot mode
X0Y6000000I5000000J0D01*	Create arc object to (0, 6) with center (5,6)

The resulting image is a full circle.

Note that arcs where the start point and end point of an arc very close together are unstable: a small change in their relative position can turn a large arc in a small one and vice versa, dramatically changing the image. A typical case is very small arcs: start and end point are close together; if due to rounding the end point is slightly moved to coincide with the start point the small arc becomes a full arc.

Rounding must be done carefully. Using high resolution is an obvious prerequisite. See 4.14. The Gerber writer must also consider that the reader unavoidably has rounding errors. Perfectly exact numerical calculation cannot be assumed. It is the responsibility of the writer to avoid unstable arcs. Arcs shorter than say 2µm must be replaced with a draw - draws are intrinsically

stable and the error is negligible. Near full arcs must be cut in two big arcs, which too are intrinsically stable.

Warning: A Gerber file that attempts to create an arc without a preceding G75 is invalid.

4.7.2.1 Example

Syntax	Comments
X3000000Y-2000000D02*	Set the current point to (3, -2) mm
G75*	Must be called before an arc is created
G03*	Set counterclockwise plot mode
X-3000000Y-2000000I-3000000J4000000D01*	Create arc object counterclockwise to (-3,-2). The offsets from the start point to the center point are 3 for X and 4 for Y, i.e. the center point is (0, 2)

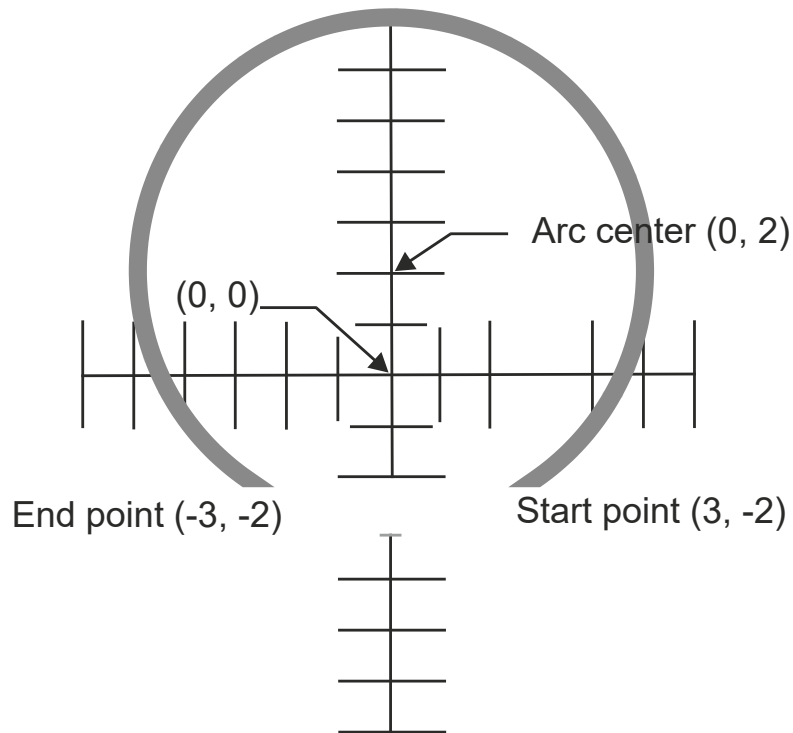

21. Arc example

4.7.2.2 Valid Arcs

Mathematically, the distance from the center to the start point must be exactly equal to the distance to the end point. However, a Gerber file has a finite resolution. It is therefore generally not possible to position the center point exactly so that both distances – radii - are indeed exactly equal. Furthermore, the software generating the Gerber file unavoidably adds rounding errors of its own. In real files the center is unavoidably not positioned exactly, and the two radii are not equal. We will call the difference between the start and end radius the *arc deviation*.

A mathematically exact circle has of course zero deviation. The interpretation of the arc command is then obvious. However, which curve is represented by a “circular arc” with a non-zero deviation? It cannot be a circular arc with the given center. Either it is not circular, it has another center, or it does not go from start to end. The curve is defined as follows.

Any continuous and monotonic curve starting at the start point and ending at the end point, approximating the ring with the given center point and with inner and outer radii equal to the start radius and end radius is a valid rendering of the arc command. See figure below.

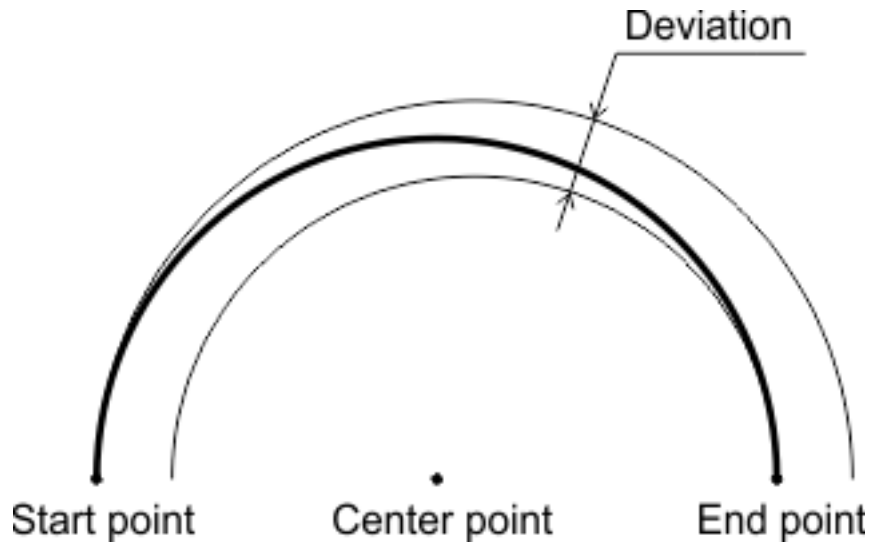

22. Arc with a non-zero deviation

The arc therefore has a fuzziness of the order of magnitude of the arc deviation. The writer of the Gerber file accepts any interpretation within the fuzziness above as valid. If the writer requires a more precise interpretation of the arc he needs to write more precise arcs, with lower deviation.

It is however not allowed to place the center point close to the straight line through begin and end point except when it is strictly in between these points. When the center is on or outside the segment between start and end point the construct is nonsensical. See figure below.

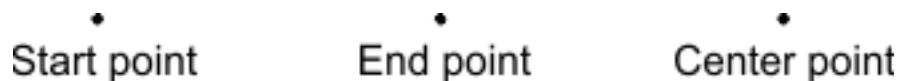

23. Nonsensical center point

Note that self-intersecting contours are not allowed, see 4.10.3. If any of the valid arc interpretations turns the contour in a self-intersecting one, the file is invalid, with unpredictable results.

The root cause of most problems with arcs is the use of low resolution. One sometimes attempts to force arcs of size of the order of e.g. 1/10 of a mil in a file with resolution of 1/10. This is asking for problems. Use high resolution. See 4.14.

4.8 Operations (D01/D02/D03)

4.8.1 Overview

Operations are commands consisting of coordinate data followed by a D01, D02 or D03 operation code.

- ❑ A D01 operation is called a *plot* operation. It creates a straight-line segment or a circular segment by plotting from the current point to the operation coordinates. Outside a region statement the segment is stroked with the current aperture to generate a draw or arc graphical object. Inside a region statement the segment is added to the contour being constructed. The current point is moved to operations coordinate before processing the next command.
- ❑ A D02 operation is called *move* operation. It moves the current point to the operation coordinates. No graphical object is generated.
- ❑ A D03 operation is called *flash* operation. It creates a flash object by replicating (flashing) the current aperture at the operation coordinates. When the aperture is flashed its origin is positioned at the coordinates of the operation. The origin of a standard aperture is its geometric center. The origin of a macro aperture is the origin used in the defining AM command. The current point is moved to operations coordinate before processing the next command.

Note that a zero-length plot outside regions generates the same image as a flash but a different type of object, one a draw or arc object. the other a flash object. Considering meta-information and attributes these are totally different. Always use a flash for representing pads!

The operations are controlled by the graphics state (see 2.3.2) as summarized in the table below. G01 sets linear, G02 sets clockwise, and G03 sets counterclockwise circular plotting.

Operation code	Inside a region statement (G36/G37)		Outside a region statement	
	Linear mode (G01)	Circular mode (G02, G03)	Linear mode (G01)	Circular mode (G02, G03)
D01	Adds linear segment to the contour under construction Moves current point	Adds circular segment to the contour under construction Moves current point	Creates a draw Moves current point	Creates an arc Moves current point
D02	Starts a new contour Moves current point		Moves current point	
D03	Not allowed		Creates a flash Moves current point	

Effect of operation codes depending on graphics state

The parameters of the operations are coordinate data. The FS and MO commands specify how to interpret the coordinate data.

Coordinate data consists of an optional X followed by a coordinate, an optional Y followed by a coordinate, and an optional I and J, each followed by a coordinate. It matches the following regex: **['X' coordinate] ['Y' coordinate] ['I' coordinate 'J' coordinate]**

Coordinates are integers, matching the regex: **[+-]?[0-9]+**

Consequently signs in coordinates are allowed; the '+' sign is optional. Coordinate data must have at least one character: zero must therefore be encoded as "0", not just omitted.



Examples:

%MOMM*%

Set unit to mm

%FSLAX36Y36*%

Set 3 integer digits and six decimal ones.

X2000000Y2000000D02*

move to (+2, +2) mm

Y-3000000D03*

flash at (+2, -3) mm

G02

clockwise circular plotting

I3000000J1000000D01*

plot to current point (+2, -3) mm, offset (+3, +1) mm

Y2000000I500000J500000D01*

plot to (+2, +2) mm, offset (+0.5, +0.5) mm

X+1000000I-500000D01*

plot to (+1, +2mm), offset (-0.5, +0.5) mm

D03*

flash at (+1, +2) mm

4.8.2 Plot (D01)

Performs a plotting operation, creating a draw or an arc segment. The plot state defines which type of segment is created, see 4.7. The syntax depends on the required parameters, and, hence, on the plot state.

Plot state	Syntax
Linear (G01)	<code>D01 = (['X' x_coordinate] ['Y' y_coordinate] 'D01') '*';</code>
Circular (G02 G03)	<code>D01 = (['X' x_coordinate] ['Y' y_coordinate] 'I' x_offset 'J' y_offset) 'D01' '*';</code>

Syntax	Comments
x_coordinate	This is of the coordinate type, according to section 4.2.2. It defines the X coordinate of the new current point. The default is the X coordinate of the old current point.
y_coordinate	As above, but for the Y coordinate
x_offset	The offset in X is of the coordinate type, according to section 4.2.2. It defines the X coordinate of the center of the circle according to section 4.7.2. There is no default offset; if the offset is 0 an explicit I0 is mandatory.
y_offset	As above, but for the Y axis.
D01	Move operation code

After the plotting operation the current point is set to X,Y.

4.8.3 Move (D02)

Moves the current point to the (X,Y) in the comment. The syntax is:

`D02 = (['X' x_coordinate] ['Y' y_coordinate] 'D02') '*';`

Syntax	Comments
x_coordinate	<Coordinate> is coordinate data – see section 4.2.2. It defines the X coordinate of the new current point. The default is the X coordinate of the old current point.
y_coordinate	As above, but for the Y coordinate.
D02	Move operation code

The D02 command sets the new value for the current point. Inside a region statement it also closes the current contour and starts a new one. (see 4.10).



Example:

X2152000Y1215000D02*

4.8.4 Flash (D03)

Performs a flash operation, creating a flash object at (X, Y). The syntax is:

D03 = (['X' x_coordinate] ['Y' y_coordinate] 'D03') '*';

Syntax	Comments
x_coordinate	<Coordinate> is an integer specifying the X coordinate of the aperture origin. The default is the X coordinate of the old current point.
y_coordinate	As above, but for the Y coordinate.
D03	Flash operation code



Example:

```
X1215000Y2152000D03*
```

After the flash operation the current point is set to (X, Y).

4.8.5 Example

The example shows a stream of commands in a Gerber file. Some of the commands are operation codes, others are G code commands (G01, G03, G36, G37, G74, and G75). The G code commands set the graphics state parameters that are relevant for the operations: plot mode (G01, G02, G03, G75) – see 4.7.



Example:

```
X275000Y115000D02*
G01*
X2512000Y115000D01*
G75*
G03*
X5005000Y3506000I3000J0D01*
G01*
X15752000D01*
Y12221000D01*
```

4.9 Aperture Transformations (LP, LM, LR, LS)

4.9.1 Overview

The commands LP, LM, LR and LS load one of the following *object transformation* graphics state parameters:

Object transformation commands		
Command	Long name	Parameter
LP	Load polarity	Polarity (Positive, Negative)
LM	Load mirroring	Mirror axis (N X Y XY)
LR	Load rotation	Rotation angle
LS	Load scaling	Scaling factor

Object transformation parameters become effective immediately after the load command and remain in effect until modified by a new load command.

An object transformation parameter transforms the polarity and shape of the current aperture at the time it creates an object. The parameter is always applied to the original current aperture; in other words, their effect is not cumulative over successive load commands.

The apertures are mirrored/rotated/scaled around the flash point according to the transformation parameters. Mirroring is performed before rotation.

As the aperture shape does not affect regions the mirror/rotate/scale parameters do not affect region creation; polarity however does.

The object transformation parameters do not affect the apertures in the aperture dictionary.



Example: how the transformation parameter affects the image

D123*	Select D123
X1000000Y7000000D03*	Flash D123
%LR90.0*%000	
X2000000Y6000000D03*	Flash D123 rotated 90 degrees
D124*	Select D124
X2000000Y5000000D03*	Flash D124 rotated 90 degrees
%LR0.0*%	Set object rotation to 0 degrees
X3000000Y4000000D03*	Flash D124 original, (not rotated)
D123*	Select D123
X4000000Y3000000D03*	Flash D123 original, (not rotated)
%LPC*%	Set polarity clear
X5000000Y2000000D03*	Flash D123 original shape, in clear
D124*	Select D123
X6000000Y1000000D03*	Flash D124 original shape, in clear

 **Example of the effect on plotting (draws and arcs)**

`%MOMM*%`

`%FSLAX26Y26*%`

`%ADD10C,1*%`

Define aperture 10 as a 1mm circle

`D10*`

Select aperture 10

`G01*`

Set linear plotting

`X00000000Y00000000D02*`

Move to origin

`X01000000D01*`

Draw a 1mm thick line

`%LS1.5*%`

Set scale factor to 1.5

`Y02000000D01*`

Draw a 1.5mm thick line

`M02*`

This results in the following image:

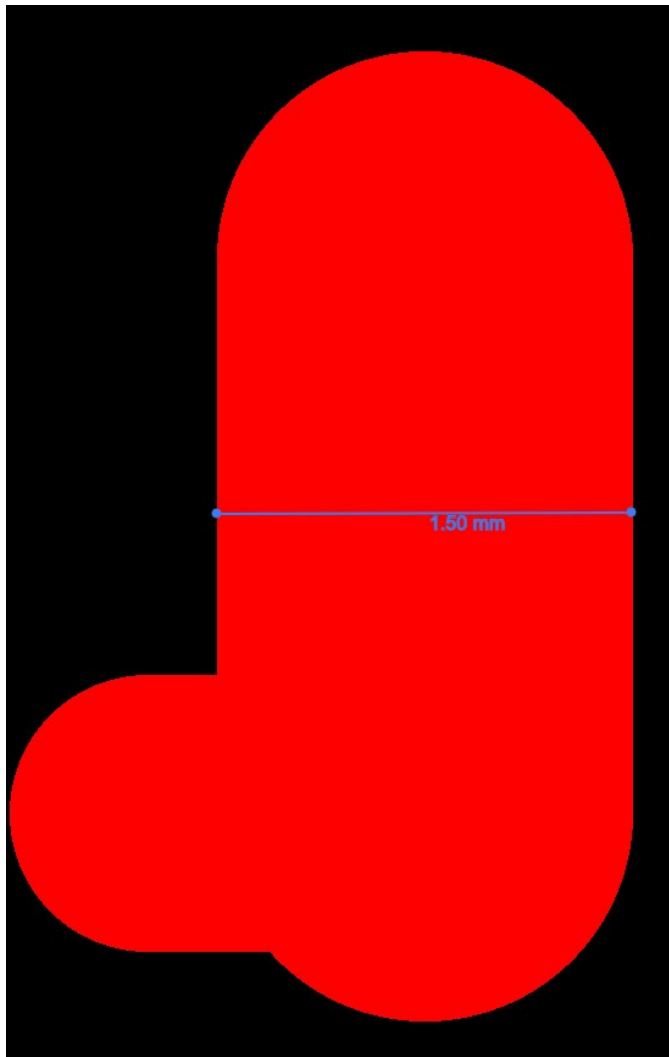

4.9.2 Load Polarity (LP)

The LP command sets the *polarity graphics state parameter*, see 2.3.2. It defines the polarity of the graphics objects when they are created. Polarity can be either *dark* or *clear*. Its effect is explained in 2.3.2. There is an example in 4.10.4.6. The syntax for the LP command is:

LP = '%' ('LP' ('C'|'D')) '*%';

Syntax	Comments
LP	LP for Load Polarity
C D	C – clear polarity D – dark polarity

The LP command can be used multiple times in a file. The polarity remains as set until overruled by another LP command.



Example. Set clear object polarity.

%LPC*%

4.9.3 Load Mirroring (LM)

The LM command sets the *mirroring graphics state parameter*, see 2.3.2. The mirroring option defines the mirroring axis used when creating objects. The aperture is mirrored around its *origin* (which may not be its geometric center) before being used. The syntax for the LM command is:

LM = '%' ('LM' ('N'|'XY'|'Y'|'X')) '*%';

Syntax	Comments
LM	LM for Load Mirroring
N X Y XY	N – No mirroring X – Mirroring <i>along</i> the X axis; mirror left to right; the signs of the x coordinates are inverted Y – Mirroring <i>along</i> the Y axis; mirror top to bottom; the signs of the y coordinates are inverted XY – Mirroring <i>along</i> both axes; mirror left to right and top to bottom; the signs of both the x <i>and</i> y coordinates are inverted



Mirroring is performed *before* the rotation.

The LM command can be used multiple times in a file. The mirroring remains as set until overruled by another LM command. Mirroring is set at the value in the command, it is *not* cumulated with the previous value.



Example. Set no object mirroring.

%LMN*%

The LM command was introduced in revision 2016.12.

4.9.4 Load Rotation (LR)

The LR command sets the *rotation graphics state parameter*, see 2.3.2. It defines the rotation angle used when creating objects. The aperture is rotated around its *origin* (which may or may not be its geometric center). The syntax for the LR command is:

LR = '%' ('LR' decimal) '%';

Syntax	Comments
LR	LR for Load Rotation
<Rotation>	The rotation angle, in degrees, counterclockwise. A decimal.

 Mirroring is performed *before* the rotation.

The LR command can be used multiple times in a file. The object rotation remains as set until overruled by a subsequent LR command. Rotation is set at the value in the command, it is *not* cumulated with the previous value.

 **Example. Set object rotation to 90°.**

```
%LR90*%
```

The LR command was introduced in revision 2016.12.

4.9.5 Load Scaling (LS)

The LS command sets the *scaling graphics state parameter*, see 2.3.2. It defines the scale factor used when creating objects. The aperture is scaled centered on its *origin* (which may or may not be its geometric center). The syntax for the LS command is:

LS = '%' ('LS' decimal) '%';

Syntax	Comments
LS	LS for Load Scaling
<Scale>	A decimal > 0.

The LS command can be used multiple times in a file. The object scaling remains as set until overruled by a subsequent LS command. Scaling is set at the value in the command, it is *not* cumulated with the previous scale factor.

 **Example. Set object scaling to 80%.**

```
%LS0.8*%
```

The LS command was introduced in revision 2016.12.

4.9.6 Example

A block flashed in different mirroring, orientation, scaling

```
G04 Ucamco copyright*
%TF.GenerationSoftware,Ucamco,UcamX,2016.04-160425*%
%TF.CreationDate,2016-04-25T00:00:00+01:00*%
%FSLAX26Y26*%
%MOMM*%
%ADD10C,1*%
%LPD*%
G04 Define block aperture D12*
%ABD12*%
%ADD11C,0.5*%
D10*
```

Revision 2026.05

- Copyright Ucamco NV

Having a question or remark about the spec? Please contact us at gerber@ucamco.com

```
G01*  
X-2500000Y-1000000D03*  
Y1000000D03*  
%LPC*%  
D11*  
X-2500000Y-1000000D03*  
%LPD*%  
X-500000Y-1000000D02*  
X2500000D01*  
G75*  
G03*  
X500000Y1000000I-2000000J0D01*  
G01*  
%AB*%  
G04 Flash block aperture D12 in four different orientation*  
D12*  
X0Y0D03*  
%LMX*%  
X1000000D03*  
%LMY*%  
%LR30.0*%  
X0Y800000D03*  
%LMXY*%  
%LR45.0*%  
%LS0.8*%  
X1000000D03*  
%LPD*%  
%LMN*%  
%LR0.0*%  
%LS1.0*%  
M02*
```

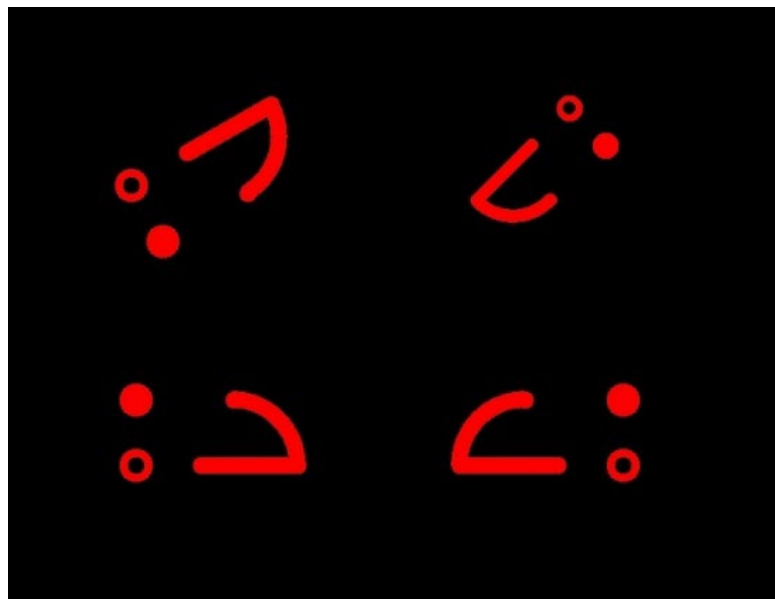

24. A block flashed in different orientations

4.10 Region Statement (G36/G37)

4.10.1 Region Overview

A region is a graphical object defined by its contour(s) - see 4.10.3.

The G36 command begins a region statement and G37 ends it. A region statement creates contour objects by defining their contour. The D01 and D02 commands create the contour segments. A D02 starts a contour, subsequent D01's add segments to it. When a D02 is encountered the current contour is finalized and a new one started. Thus an unlimited number of contours can be created between a single G36/G37 commands pair. When a G37 is encountered the contour is finalized and the region statement is closed. A contour can only be finalized if it is explicitly *closed*, meaning that the last vertex *exactly* coincides with the first one – beware of rounding errors. The commands D01, D02, G01, G02 and G03 are the *only* commands allowed within a region statement.

When a G37 command is encountered the region statement is finalized and region graphical objects are added to the object stream by filling the newly created contours. A G37 is only allowed when all its contours are properly closed. Each contour is filled individually. The overall filled area is the union of the filled areas of each individual contour. The number of region objects created by a single G36/G37 pair is intentionally *not* specified to leave more freedom to implementations; - for example, two overlapping contours may be merged in a single region object.

Holes in a region are defined with cut-ins (see 4.10.3 and 4.10.4.7).

Contour segments are not in themselves graphical objects –they define the regions which are graphical objects.

Object attributes can be attached to a region. Note that although no aperture is involved in creating a region, *aperture attributes can be attached to a region*, see 5.3.1. The rationale is that objects constructed with an aperture can *inherit* aperture attributes from it. As regions cannot get aperture attributes through inheritance these attributes must be attached directly to the region. A way to view this is that a virtual region attribute permanently sits in the aperture dictionary, is involved in creating all regions, and the regions inherit from the virtual region attribute.

4.10.2 Region Statement Syntax

The G36 and G37 commands begin and end a region statement respectively. The syntax is:

```
G36 = 'G36*';
G37 = 'G37*';
region_statement = G36 {contour}+ G37;
contour = D02 {D01|G01|G02|G03}*;
```

Syntax	Comments
G36	Begins a region statement.
G37	Ends a region statement. This creates the region graphical objects. It does <i>not</i> implicitly closes the contours.

A valid region statement must not only comply with this syntax, but the sequences of draws/arcs must represent a connected closed contour that does not self-intersect. See 4.10.3.

4.10.3 Valid Contours

A contour is a sequence of connected linear or circular segments. A pair of segments is said to connect only if they are defined consecutively, with the second segment starting where the first one ends. Thus, the order in which the segments are defined is significant. Non-consecutive segments that meet or intersect fortuitously are not considered to connect. A contour is closed: the end point of the last segment must coincide with the start point of the first segment. A contour thus defines a closed curve.

There are two classes of valid contours.

Simple contours. A contour is said to be *simple* if all its segments are disjoint, except for consecutive segments having only their connection point in common. Note that zero-length draws and full circles violate this rule and are therefore not allowed. (Be careful that rounding to file resolution does not inadvertently creates them.) A simple contour does not self-intersect or self-touch. The inside of the contour constitutes the region object. A simple contour defines a simple region, without holes.

Simple cut-in contours. These contours allow to create a region with holes. A cut-in connects the contour defining the hole to its enclosing contour, thus joining them into a single contour. If one travels along the contour in the direction of the segments and the inside must always be to the same side, just as for simple contours. See the illustration below; see 4.10.4.7 for a fully worked out example.

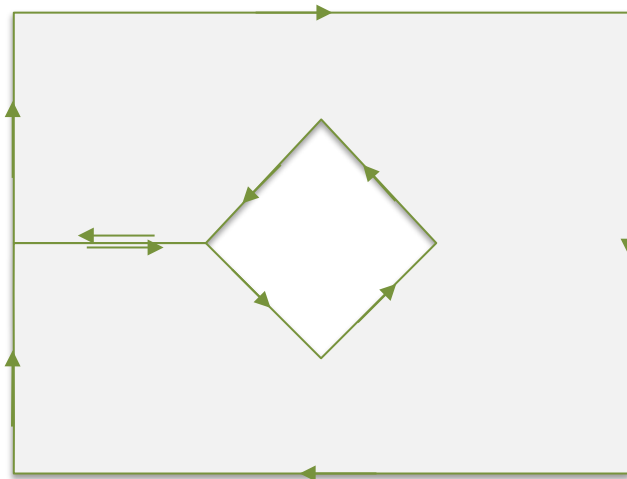

25. A contour with a cut-in

Cut-ins are subject to strict requirements:

- ❑ it must consist of two *fully-coincident* linear segments; a pair of linear segments are said to be fully coincident if the segments coincide, with the second segment starting where the first one ends
- ❑ cut-ins must be either horizontal or vertical
- ❑ all cut-ins in a contour must have the same direction, either horizontal or vertical;
- ❑ cut-ins can only touch or overlap the contour in their start and end points.

Any other form of self-touching, self-intersection or self-overlapping is *not allowed*. For the avoidance of doubt, not allowed are, amongst others: segments that partially overlap, fully-coincident linear segments that are diagonal, fully-coincident circular segments, circular segments that are tangent to another segment, vertices on a segment at another location than its endpoints, points where more than two segments end, full arcs except when the contour

consist solely of that full arc or the full arc is at the end of a cut-in. An invalid contour has no specified interpretation.

For the mathematically inclined: A contour is said to be *weakly simple* if there exists an infinitesimal perturbation of the vertices changing it in a simple contour. Simple contours with cut-ins are weakly simple. The winding number for valid contours is for the outside 0 and for the inside everywhere either +1 or -1, depending on the direction of the contour. However, not all weakly simple contours or contours with these winding numbers are valid.

Contours are also used to define outline primitives in macro apertures (see 4.5.1.6).

Processing Gerber files is inevitably subject to rounding errors. Contours must be constructed robustly so that these unavoidable rounding error do not turn an otherwise valid contour in a self-intersecting one. See 4.14.2.

In Gerber, the direction of the contour is not significant.

 **Warning:** Use maximum resolution. Low file coordinate resolution brings uncontrolled rounding and often results in self-intersecting contours, see 4.1.

 **Warning:** Sloppy construction of cut-ins can lead to self-intersecting contours – in fact this is the most prevalent cause of missed clearances in planes. Construct cut-ins carefully or avoid them altogether by making holes in regions with negative objects.

4.10.4 Examples

4.10.4.1 A Simple Contour

Syntax	Comments
G36*	Begins a region statement
X2000000Y3000000D02*	Set the current point to (2, 3), beginning a contour.
G01*	Set linear plot mode
X7000000D01*	Create linear segment to (7, 3)
Y1000000D01*	Create linear segment to (7, 1)
X11000000Y5000000D01*	Create linear segment to (11, 5)
X7000000Y9000000D01*	Create linear segment to (7, 9)
Y7000000D01*	Create linear segment to (7, 7)
X2000000D01*	Create linear segment to (2, 7)
Y3000000D01*	Create linear segment to (2, 3), closing the contour.
G37*	Create the region by filling the contour

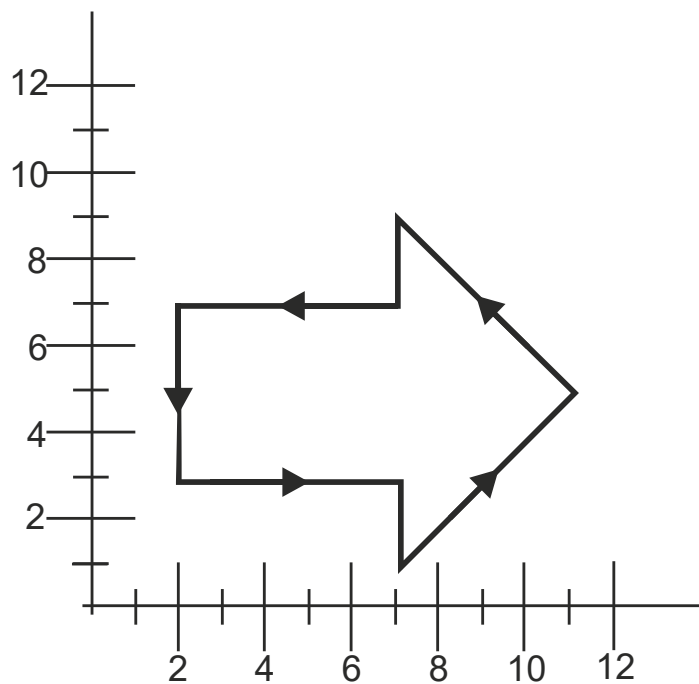

26. Simple contour example: the segments

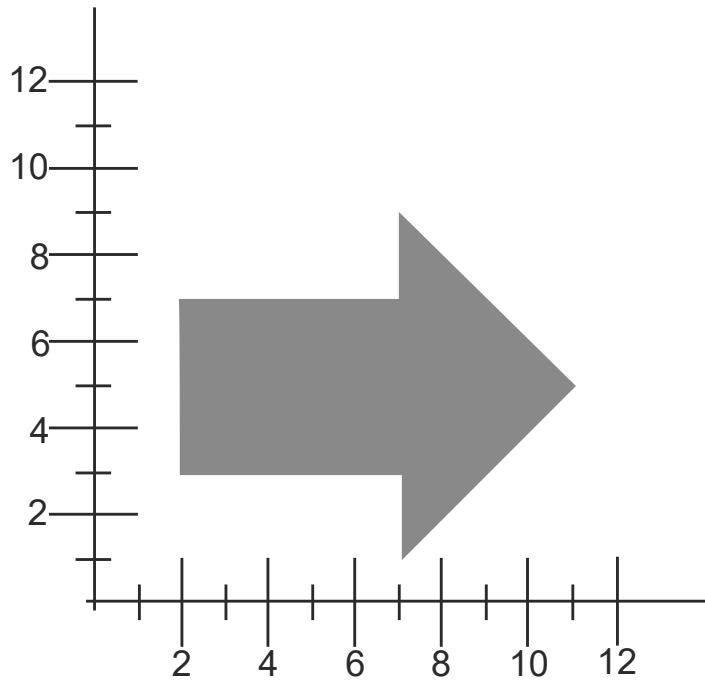

27. Simple contour example: resulting image

4.10.4.2 Use D02 to Start a Second Contour

D02 command can be used to start the new contour. All the created contours are converted to regions when the command G37 is encountered. The example below creates two non-overlapping contours which are then converted into two regions.



Example:

```
G04 Non-overlapping contours*  
%MOMM*%  
%FSLAX26Y26*%  
%ADD10C,1.00000*%  
G01*  
%LPD*%  
G36*  
X0Y5000000D02*  
Y10000000D01*  
X10000000D01*  
Y0D01*  
X0D01*  
Y5000000D01*  
X-1000000D02*  
X-5000000Y1000000D01*  
X-9000000Y5000000D01*  
X-5000000Y9000000D01*  
X-1000000Y5000000D01*  
G37*  
M02*
```

This creates the following image:

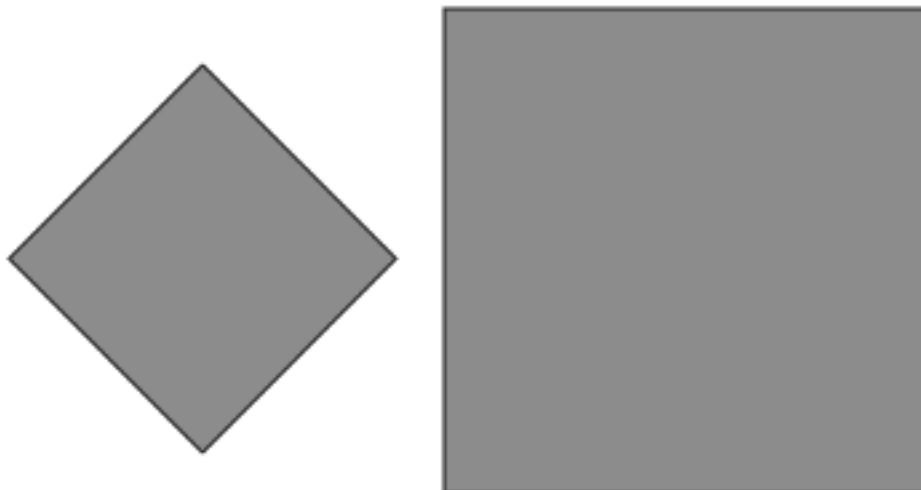

28. Use of D02 to start a new non-overlapping contour.

Two different contours were created. Each contour is filled individually. The filled area is the union of the filled areas.

Revision 2026.05

- Copyright Ucamco NV

Having a question or remark about the spec? Please contact us at gerber@ucamco.com

4.10.4.3 Overlapping Contours

The example below creates two overlapping contours which are then converted into one region.



Example:

```
G04 Overlapping contours*  
%FSLAX26Y26*%  
%MOMM*%  
%ADD10C,1.00000*%  
G01*  
%LPD*%  
G36*  
X0Y5000000D02*  
Y10000000D01*  
X10000000D01*  
Y0D01*  
X0D01*  
Y5000000D01*  
X1000000D02*  
X5000000Y1000000D01*  
X9000000Y5000000D01*  
X5000000Y9000000D01*  
X1000000Y5000000D01*  
G37*  
M02*
```

This creates the following image:

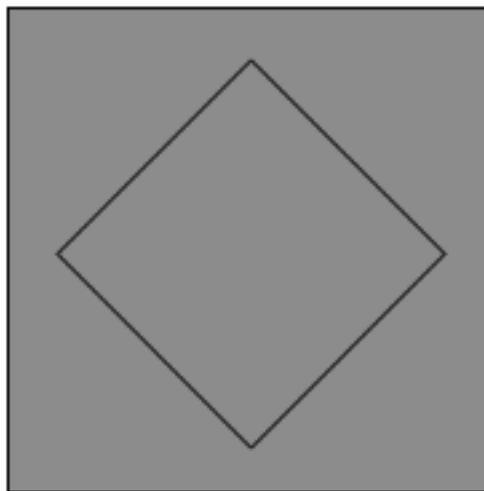

29. Use of D02 to start a new overlapping contour

Two different contours were created. Each contour is filled individually. The filled area is the union of the filled areas. As the second contour is completely embedded in the first, the effective

filled area is the one of the first contour. The created region object is the same as would be defined by the first contour only.

4.10.4.4 Non-overlapping and Touching

The example below creates two non-overlapping touching contours which are then converted into one region.



Example:

```
G04 Non-overlapping and touching*
%FSLAX26Y26*%
%MOMM*%
%ADD10C,1.00000*%
G01*
%LPD*%
G36*
X0Y5000000D02*
Y10000000D01*
X10000000D01*
Y0D01*
X0D01*
Y5000000D01*
D02*
X-5000000Y1000000D01*
X-9000000Y5000000D01*
X-5000000Y9000000D01*
X0Y5000000D01*
G37*
M02*
```

This creates the following image:

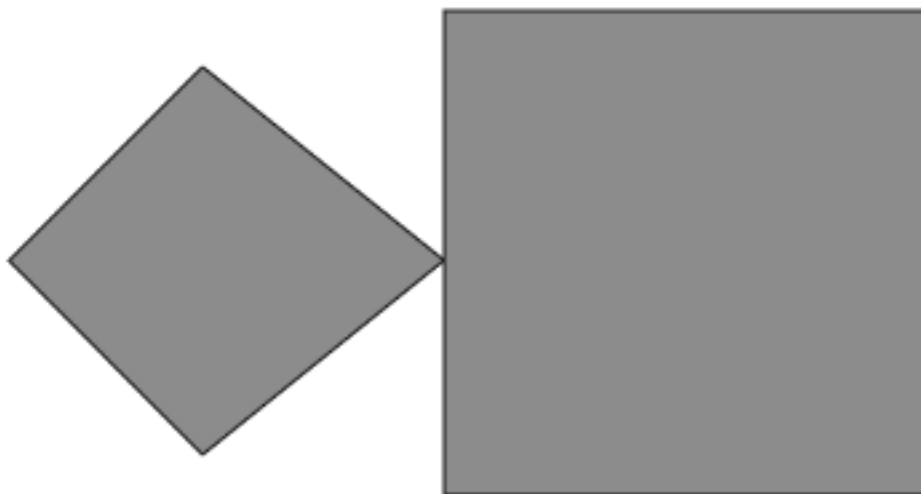

30. Use of D02 to start a new non-overlapping contour

As these are two different contours in the same region touching is allowed.

4.10.4.5 *Overlapping and Touching*

The example below creates two overlapping touching contours which are then converted into one region.



Example:

```
G04 Overlapping and touching*  
%FSLAX26Y26*%  
%MOMM*%  
%ADD10C,1.00000*%  
G01*  
%LPD*%  
G36*  
X0Y5000000D02*  
Y10000000D01*  
X10000000D01*  
Y0D01*  
X0D01*  
Y5000000D01*  
D02*  
X5000000Y1000000D01*  
X9000000Y5000000D01*  
X5000000Y9000000D01*  
X0Y5000000D01*  
G37*  
M02*
```

This creates the following image:

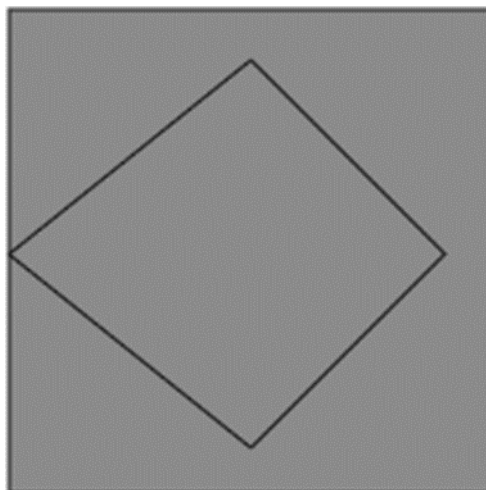

31. Use of D02 to start a new overlapping and touching contour

As these are two different contours in the same region touching is allowed.

4.10.4.6 Using Polarity to Create Holes

The recommended way to create holes in regions is by alternating dark and clear polarity, as in the following example. Initially the polarity mode is dark. A big square region is generated. The polarity mode is set to clear and a circular disk is added to the object stream; the disk is cleared from the image and creates a round hole in the big square. Then the polarity is set to dark again and a small square is added, darkening the image inside the hole. The polarity is set to clear again and a small disk added, clearing parts of the big and the small squares.



Example:

```
G04 This file illustrates how to use polarity to create holes*
%FSLAX36Y36*%
%MOMM*%
G01*
G04 First object: big square - dark polarity*
%LPD*%
G75*
G36*
X25000000Y25000000D02*
X175000000D01*
Y175000000D01*
X25000000D01*
Y25000000D01*
G37*
G04 Second object: big circle - clear polarity*
%LPC*%
G36*
X50000000Y100000000D02*
G03*
X50000000Y100000000I50000000J0D01*
G37*
G04 Third object: small square - dark polarity*
%LPD*%
G01*
G36*
X75000000Y75000000D02*
X125000000D01*
Y125000000D01*
X75000000D01*
Y75000000D01*
G37*
G04 Fourth object: small circle - clear polarity*
%LPC*%
G36*
X115000000Y100000000D02*
G03*
X115000000Y100000000I25000000J0D01*
G37*
```

M02*

Below there are pictures which show the resulting image after adding each object.



32. Resulting image: first object only



33. Resulting image: first and second objects

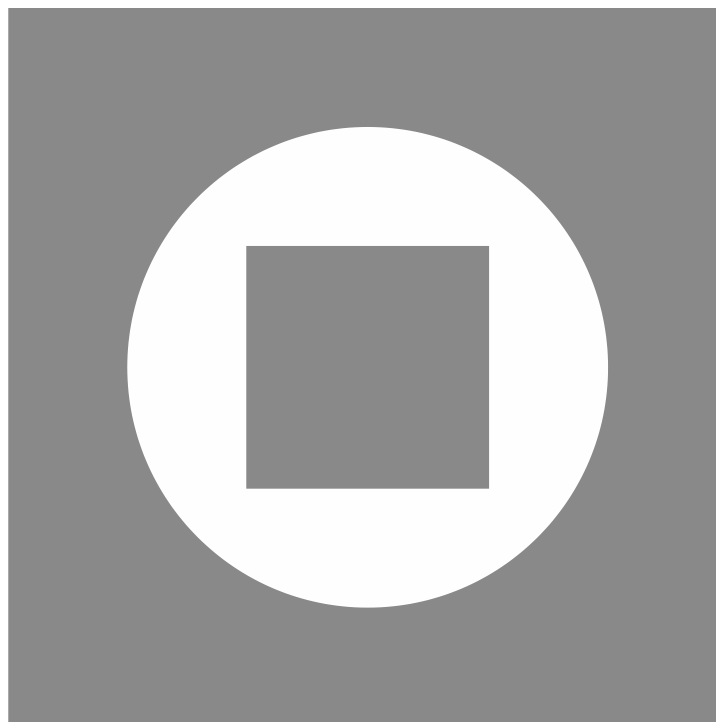

34. Resulting image: first, second and third objects



35. Resulting image: all four objects

4.10.4.7 A Simple Cut-in

The example below illustrates how a simple cut-in creates a hole in a region. The coinciding contour segments must follow the requirements in 4.10.3.

Syntax	Comments
%FSLAX26Y26*%	Format specification
G75*	G75 must be called before an arc is created.
G36*	Begins a region statement.
X2000000Y1000000D02*	Start the contour at (2,10).
G01*	Set linear plot mode.
X1200000D01*	Create linear contour segment to (12,10.)
Y200000D01*	Create linear contour segment to (12, 2).
X200000D01*	Create linear contour segment to (2, 2).
Y600000D01*	Create linear contour segment to (2, 6).
X500000D01*	Create lin. segment to (5, 6), 1 st fully coincident segment.
G03*	Set counterclockwise circular plot mode.
X500000Y600000I300000J0D01*	Create counterclockwise circle with radius 3.
G01*	Set linear plot mode.
X200000D01*	Create lin. segment to (2, 6), 2 nd fully coincident segment.
Y100000D01*	Create linear segment to (2, 10), closing the contour.
G37*	Create the region by filling the contour.

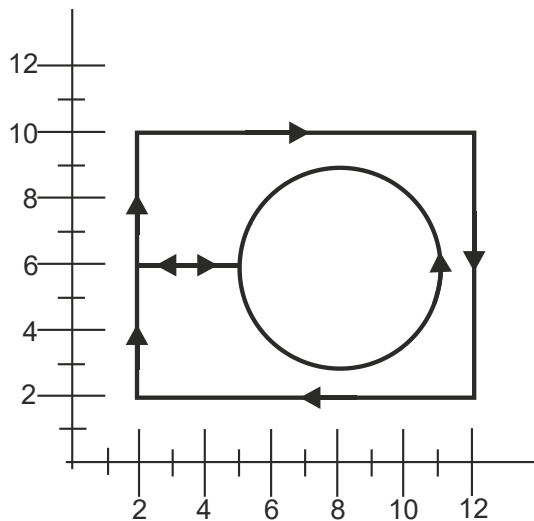

36. Simple cut-in: the segments

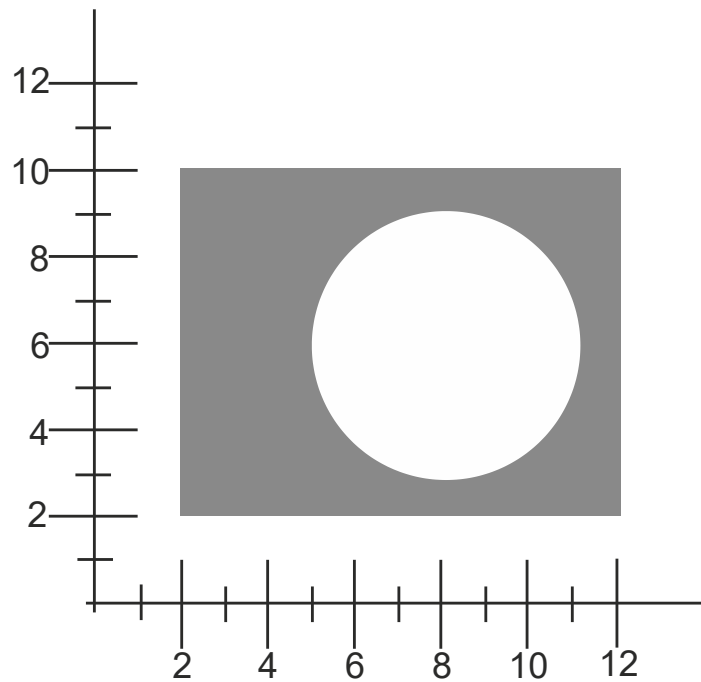

37. Simple cut-in: the image

Note the direction of the inner circle. If the direction would be different the contour would be self-intersecting. This becomes immediately apparent if you try to perturb the contour to convert it to a simple contour.

4.10.4.8 Fully-coincident Segments

The first example below illustrates how one contour may result in two regions. This happens because there are two fully-coincident linear segments which give the gap between filled areas.



Example:

```
G04 Example contour: two disjunct areas*
%FSLAX26Y26*%
%MOMM*%
G36*
X0Y5000000D02*
G01*
Y10000000D01*
X10000000D01*
Y0D01*
X0D01*
Y5000000D01*
G04 first fully-coincident linear segment*
X-1000000D01*
X-5000000Y1000000D01*
X-9000000Y5000000D01*
X-5000000Y9000000D01*
```

```
X-1000000Y5000000D01*
G04 second fully-coincident linear segment*
X0D01*
G37*
M02*
```

This creates the following image:

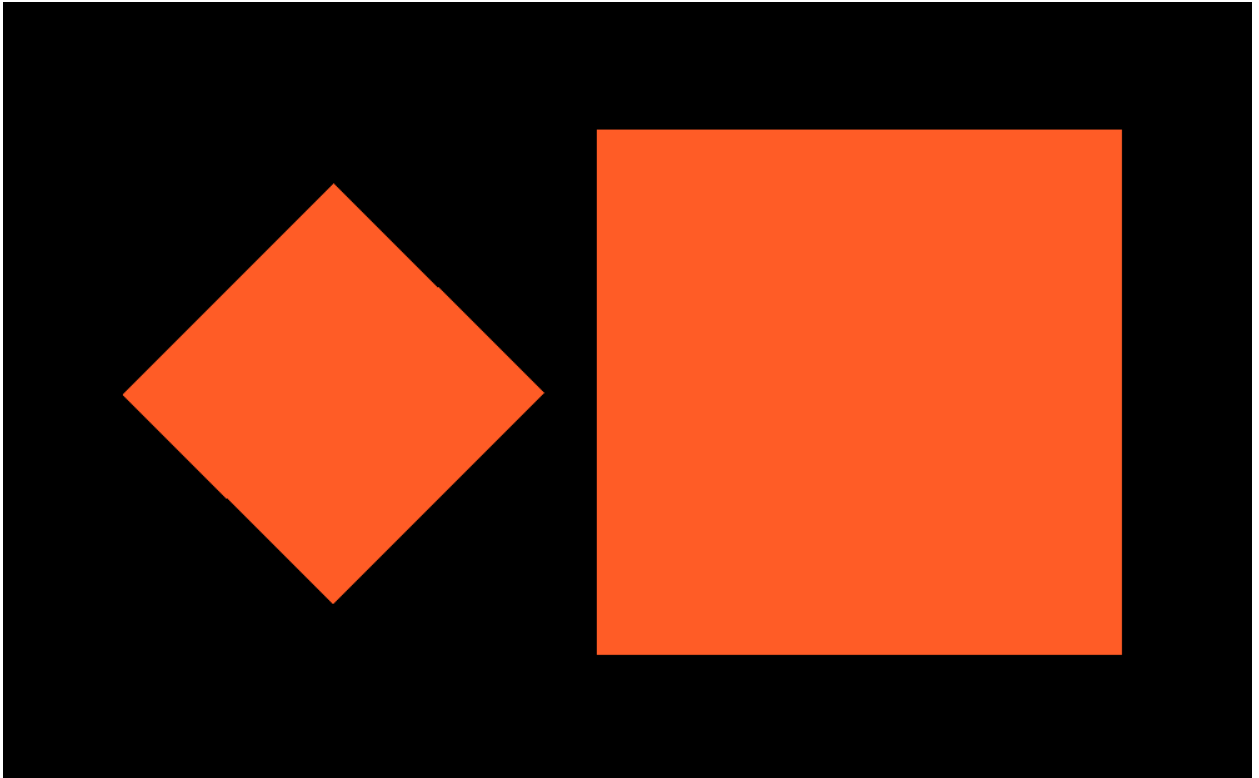

38. Fully-coincident segments in contours: two regions

The second example illustrates how one contour can create a region with hole.



Example:

```
G04 Example contour: Region with hole*
%FSLAX26Y26*%
%MOMM*%
G36*
X0Y5000000D02*
G01*
Y10000000D01*
X10000000D01*
Y0D01*
X0D01*
Y5000000D01*
G04 first fully-coincident linear segment*
X1000000D01*
X5000000Y1000000D01*
```

```
X9000000Y5000000D01*
X5000000Y9000000D01*
X1000000Y5000000D01*
G04 second fully-coincident linear segment*
X0D01*
G37*
M02*
```

This creates the following image:

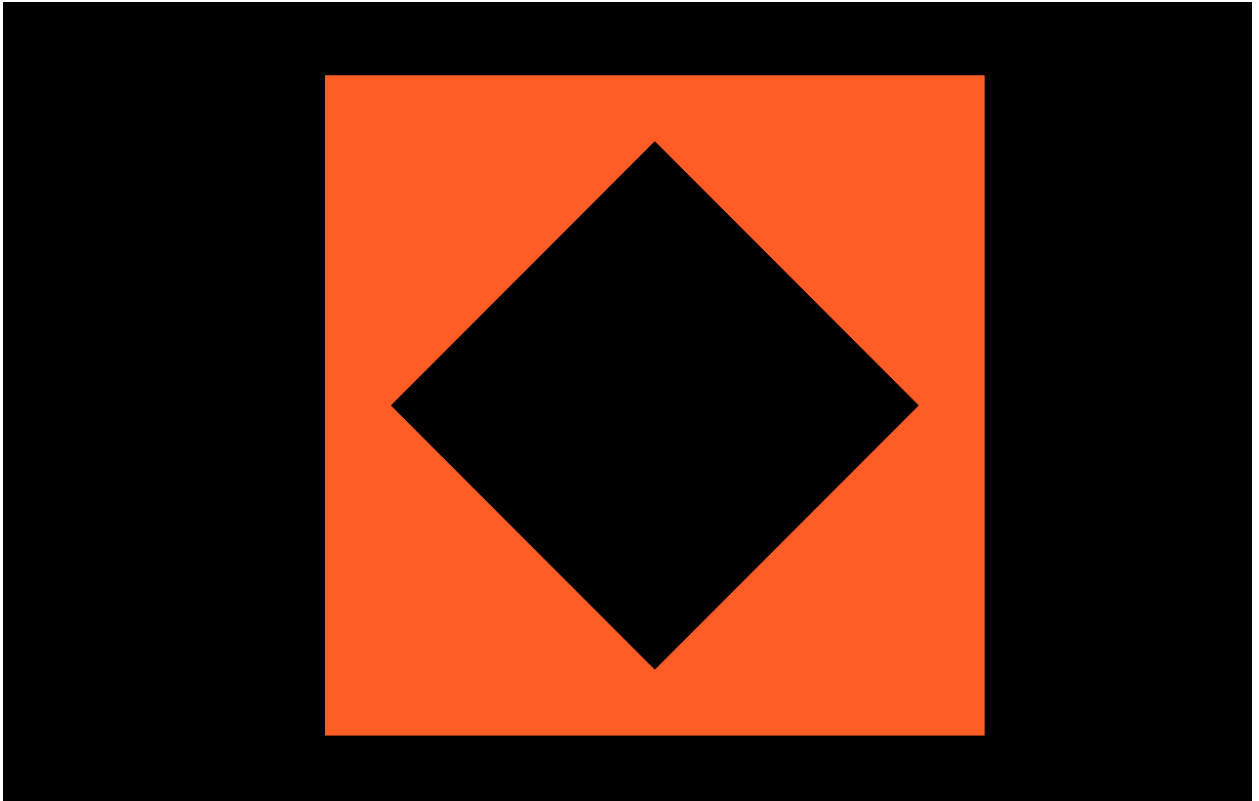

39. Fully-coincident segments in contours: region with hole

4.10.4.9 Valid and Invalid Cut-ins

Contours with cut-ins are susceptible to rounding problems: when the vertices move due to the rounding the contour may become self-intersecting. This may lead to unpredictable results. The first example below is a cut-in with valid fully-coincident segments, linear segments which have the *same* end vertices. When the vertices move due to rounding, the segments will remain exactly on top of one another, and no self-intersections are created. This is a valid and robust construction.



Example:

```
G04 Example contour: Region with two holes*
%FSLAX26Y26*%
%MOMM*%
G36*
X122000000Y257000000D02*
G01*
Y272000000D01*
```

X131000000D01*
 Y257000000D01*
 X125000000D01*
 Y260000000D01*
 X129000000D01*
 Y264000000D01*
 X125000000D01*
 Y267000000D01*
 X129000000D01*
 Y270000000D01*
 X125000000D01*
 Y267000000D01*
 Y264000000D01*
 Y260000000D01*
 Y257000000D01*
 X122000000D01*
 G37*
 M02*

This results in the following contour:

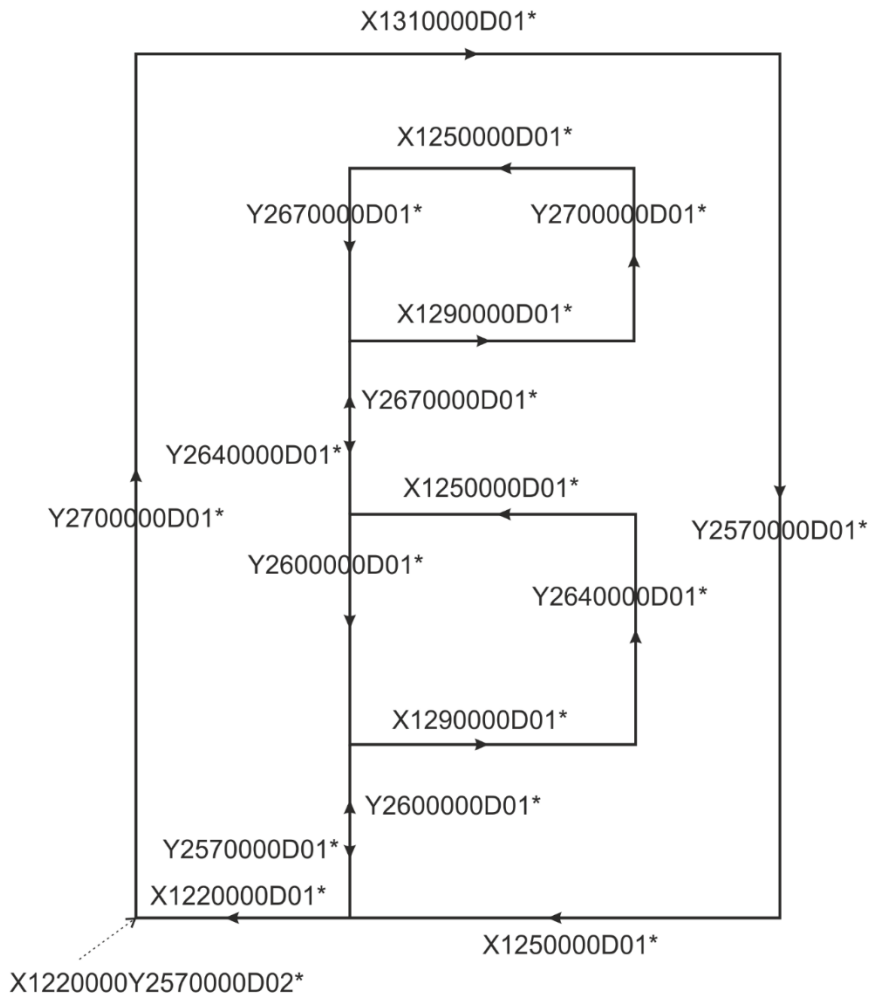

40. Valid cut-in: fully-coincident segments

This creates the following image:



41. Valid cut-in: resulting image

The next example attempts to create the same image as the first example from above, but it is *invalid* due to the use of invalid partially coinciding segments (see the description of a valid contour in 4.10.3). The number of linear segments has been reduced by eliminating vertices between collinear segments, creating invalid overlapping segments. This construction is *invalid*. It is prohibited because it is not robust and hard to handle: when the vertices move slightly due to rounding, the segments that were on top of one another may become intersecting, with unpredictable results.



Example:

```
%FSLAX36Y36*%
%MOMM*%
G36*
X111000000Y257000000D02*
G01*
Y260000000D01*
X114000000D01*
```

Y264000000D01*
X111000000D01*
Y267000000D01*
X114000000D01*
Y270000000D01*
X111000000D01*
Y257000000D01*
X109000000D01*
Y272000000D01*
X117000000D01*
Y257000000D01*
X111000000D01*
G37*
M02*

This results in the following contour:

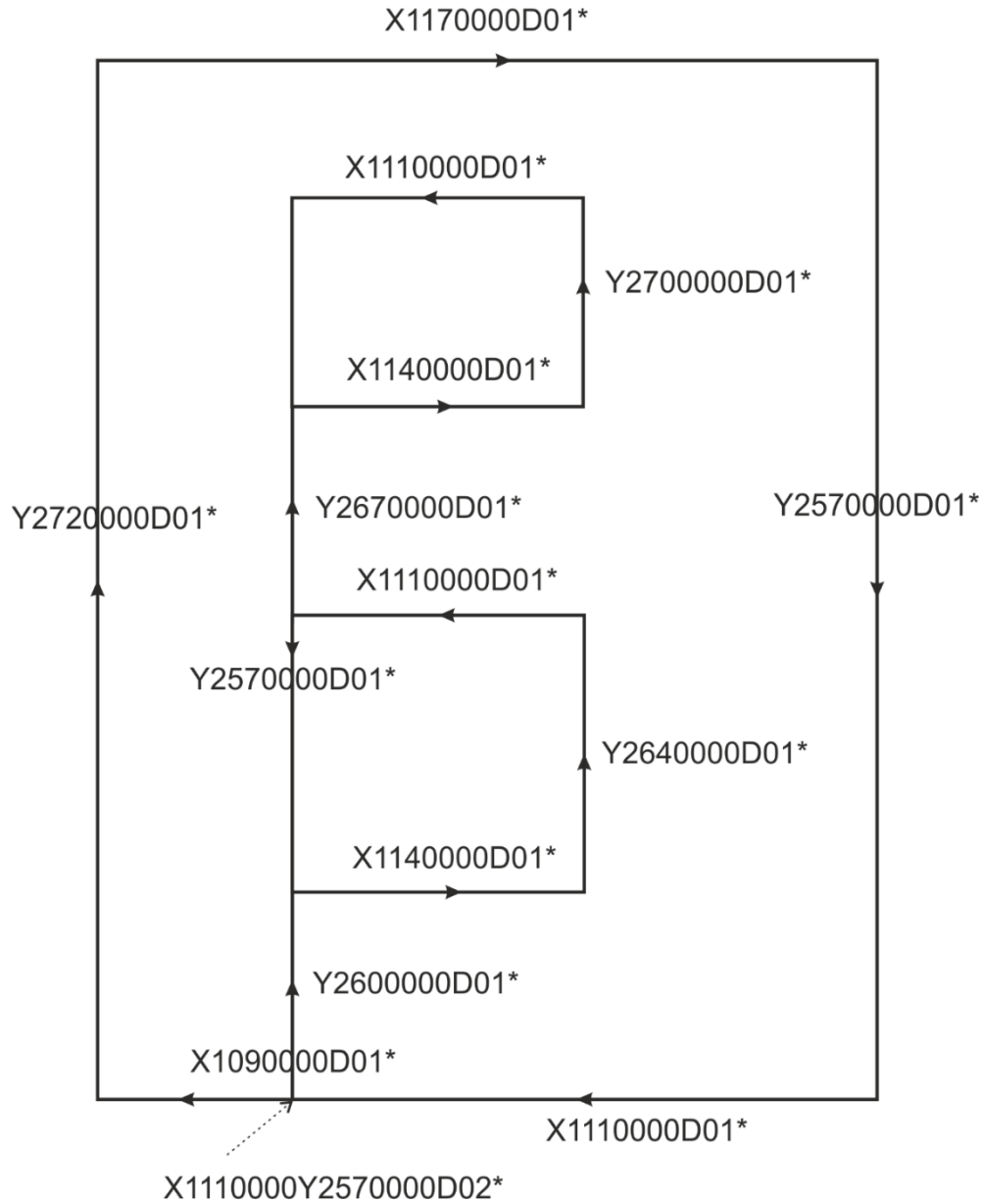

42. Invalid cut-in: overlapping segments

4.10.5 Copper Pours, Power and Ground Planes

The simplest way to construct power and ground planes is first to create the copper pour with a region in dark polarity (LPD), and then erase the clearances by switching to clear polarity (LPC). Note the clear polarity objects erase everything under them, so the copper pours and clearances are best output first.



Example:

```
G04 We define the antipad used to create the clearances*
%TA.AperFunction, AntiPad*%
%ADD11C...*%
```

Revision 2026.05

- Copyright Ucamco NV

Having a question or remark about the spec? Please contact us at gerber@ucamco.com

```
...  
G04 We now define the copper pour as a region*  
LPD*  
G36*  
X...Y...D02*  
X...Y...D01*  
...  
G37*  
G04 We now flash clearances*  
%LPC*%  
D11*  
X...Y...D03*
```

This is simple and clear. In CAD the location of the anti-pads and other clearances is known. Outputting these directly transfers shape and location information to CAM in a simple way.

Clearances in power and ground planes can also be constructed with cut-ins, as below.

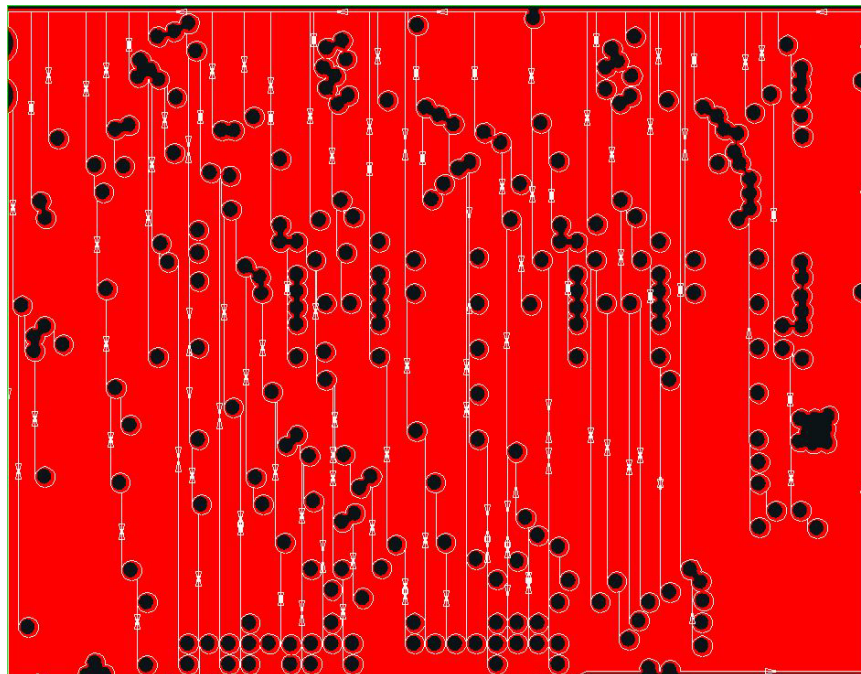

43. Power and ground planes with cut-ins.

The cut-ins are rather complex to create on output; in CAM the cut-ins must be removed on input and the original clearances restored, again rather complex. Avoid this more complex construction if at all possible.

Care must be taken to only create valid cut-ins. Sloppy cut-ins are the most frequent cause of scrap due to faulty Gerber files, causing a self-intersecting contour and a missing clearance. Below is an example of such sloppy cut-in; it is a real-life example that lead to expensive scrap. Watch out for rounding errors. Make sure that coincident points indeed are coincident in the file. With the highest resolution on outputs reduces rounding errors.

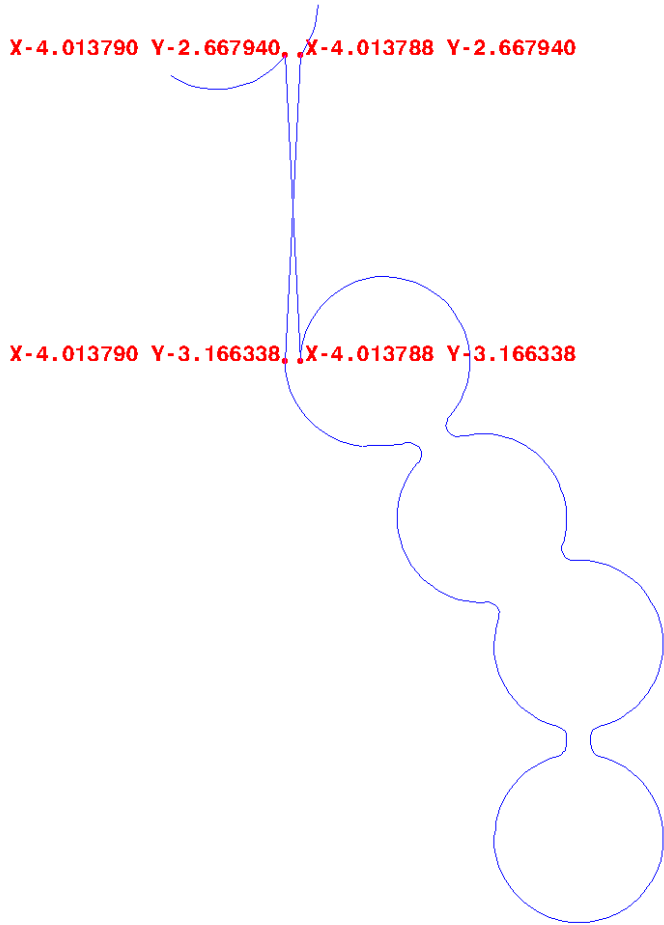

44. Power plane with invalid cut-in.

It is sometimes recommended to avoid the cut-ins altogether by splitting the plane in separate pieces, where no piece has holes. Do not follow this terrible recommendation. The remedy is worse than the disease. Splitting the single contour in separate contours without holes is as complex as adding cut-ins. All clearance boundaries must be cut in pieces and split over different contours; not much of an improvement over finding cut-in points. Rounding errors still lurk, and can lead to pieces that are no longer connected; not much of an improvement over invalid cut-ins. The situation is far worse on input. If the plane consists of a single contour it is clear it is a single plane. When planes are split in pieces the coherence is lost. The file reader must figure out from a bewildering set of contours that a single plane is intended. It must recover clearances which boundaries are scattered over different contours. Cutting a plane in pieces to avoid clearances is bad practice. It is asking for problems. See also 4.14.

4.11 Block Aperture (AB)

4.11.1 Overview of block apertures

The AB command creates a *block aperture*: The command stream between the opening and closing AB command defines the content of the block aperture. The block aperture is added to the aperture dictionary under the given aperture number by the closing AB command. Thus, the AB command adds an aperture to the dictionary directly, without needing an AD command. The LM, LR, LS and LP commands affect the flashes of block apertures as with any other aperture: when a block aperture is flashed, it is first transformed according to the graphics state transformation parameters and then appended to the object stream.

A block aperture is *not* a single graphical object but an ordered list of objects, each with their own polarity. While a standard or macro aperture always appends a single graphical object to the stream, a block aperture can add any number. Standard and macro apertures always have a single polarity while block apertures can contain both dark and clear objects.

If the polarity is dark (LPD) when the block is flashed then it is appended as is. If the polarity is clear (LPC) then the polarity of all objects in the block is toggled (clear becomes dark, and dark becomes clear). This toggle propagates through all nesting levels. In the following example the polarity of objects in the flash of block D12 will be toggled.

```
%ABD12*%
...
%AB*%
...
D12*
%LPC*%
X-2500000Y-1000000D03*
```

Flashing a block aperture updates the current point but otherwise leaves the graphics state unmodified, as with any other aperture.

The origin of the block aperture is the (0,0) point of the file.

The AB command was introduced in revision 2016.12.

4.11.2 AB Statement Syntax

The syntax for the AB command is:

<AB command> = AB[<block aperture number>]*

Syntax	Comments
AB	AB for Aperture Block. Opens/closes an AB statement.
<block aperture number>	The aperture number under which the block is stored in the aperture dictionary. It must be an integer ≥ 10.

Examples:

Syntax	Comments
%ABD12*%	Opens the definition of aperture D12
%AB*%	Closes the current AB statement.

The section between the opening and closing AB commands can contain nested AB commands. The resulting apertures are stored in the library and are available subsequently until the end of the file, also outside the enclosing AB section. The syntax is:

```
AB_statement = AB_open block AB_close;
AB_open =    '%' ('AB' aperture_ident) '*%';
AB_close =   '%' ('AB') '*%';
```

```
block =
    {
    | D01
    | D02
    | D03
    | G01
    | G02
    | G03
    | G75
    | Dnn
    | G04
    | TO
    | TD
    | TA
    | TF
    | AD
    | AM
    | LP
    | LM
    | LR
    | LS
    | region_statement
    | AB_statement
    }*
;
```

Consequently, an AB statement can contain embedded AB statements. It *cannot* contain an SR statement.

In Gerber, the scope of a name is from its definition till the end of the file. Consequently, names defined by an AB statement are available in the whole file, after their first use.

After an AB statement the graphics state remains as it is at the end of the AB definition, except for the current point, which is undefined. (Gerber has no stack of graphics states.)

4.11.3 Usage of Block Apertures

The purpose of block apertures is to repeat a sub-image without the need to repeat all the generating commands. Block apertures can be repeated at *any* location and *individually* mirrored, rotated and scaled. Block apertures are more powerful than the SR command: the SR only allows repeats on a regular grid, without mirror, rotate or scale, and, crucially, without nesting. Blocks are typically used to create panels without duplicating the data.

The second purpose of block apertures is to complement macro apertures. A block aperture consisting of a single region creates a single object with one polarity– as with standard or macro apertures. Thus, single object apertures of any shape can easily be created. Such a block aperture can be used to define pads. Blocks are simpler to create than macros. However, macros can have parameters and blocks cannot. On the other hand, a macro outline primitive support only linear segments while the contours in blocks support both linear and circular segments.

Do not use blocks – or macros - when a standard aperture is available. Standard apertures are built-in and therefore are processed faster.

4.11.4 Example



A complete Gerber file with nested blocks

```
G04 Ucamco copyright*
%TF.GenerationSoftware,Ucamco,UcamX,2016.04-160425*%
%TF.CreationDate,2016-04-25T00:00;00+01:00*%
%TF.Part,Other,Testfile*%
%FSLAX46Y46*%
%MOMM*%
G04 Define standard apertures*
%ADD10C,7.500000*%
%ADD11C,15*%
%ADD12R,20X10*%
%ADD13R,10X20*%
G04 Define block aperture 100, consisting of two draws and a round dot*
%ABD100*%
D10*
X65532000Y17605375D02*
Y65865375D01*
X-3556000D01*
D11*
X-3556000Y17605375D03*
%AB*%
G04 Define block aperture 102, consisting of 2x3 flashes of aperture 101
and 1 flash of D12*
%ABD102*%
G04 Define nested block aperture 101, consisting of 2x2 flashes of
aperture 100*
%ABD101*%
D100*
X0Y0D03*
X0Y700000000D03*
X100000000Y0D03*
X100000000Y700000000D03*
%AB*%
D101*
X0Y0D03*
X0Y160000000D03*
X0Y320000000D03*
X230000000Y0D03*
X230000000Y160000000D03*
X230000000Y320000000D03*
D12*
X19500000Y-10000000D03*
%AB*%
G04 Flash D13 twice outside of blocks*
```

D13*
X-30000000Y10000000D03*
X143000000Y-30000000D03*
G04 Flash block 102 3x2 times*
D102*
X0Y0D03*
X0Y520000000D03*
X500000000Y0D03*
X500000000Y520000000D03*
X1000000000Y0D03*
X1000000000Y520000000D03*
M02*

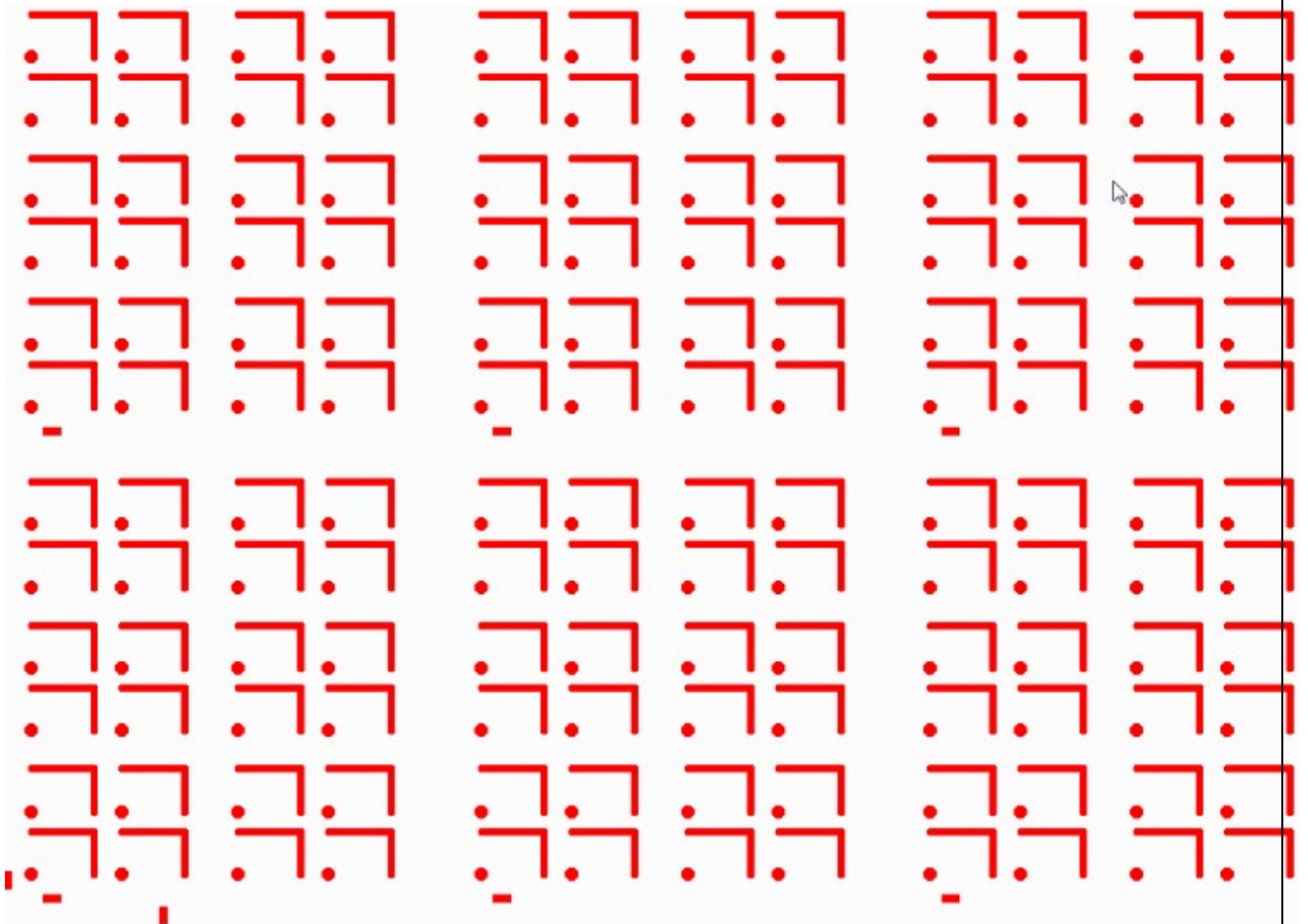

45. Block aperture example 1

4.12 Step and Repeat (SR)

The purpose of the SR command is to replicate a set of graphical objects without replicating the commands that creates the set.

The SR command `%SRX...Y...I...J...*%` opens an *SR statement*. All subsequent commands are part of the SR statement until it is closed by an `%SR*%`. The parameters X, Y specify the number of repeats in X and Y and I, J their step distances. The graphical objects generated by the command stream in a SR statement are collected in a *block* - see 2.4 - instead of being added directly to the object stream. When the SR command is closed by an `%SR*%`, the block is step-repeated (replicated) in the image plane according to the parameters X, Y, I and J in the opening SR command. Blocks are copied first in the positive Y direction and then in the positive X direction. The syntax for the SR command is:

<SR command> = SR[X<Repeats>Y<Repeats>I<Distance>J<Distance>]*

Syntax	Comments
SR	SR for Step and Repeat
X<Repeats>	Defines the number of times the block is repeated along the X axis. <Repeats> is an integer ≥ 1
Y<Repeats>	Defines the number of times the block is repeated along the Y axis. <Repeats> is an integer ≥ 1
I<Distance>	Defines the step distance along the X axis. <Distance> is a decimal number ≥ 0, expressed in the unit of the MO command..
J<Distance>	Defines the step distance along the Y axis. <Distance> is a decimal number ≥ 0, expressed in the unit of the MO command.



Warning: The step distances are not expressed in coordinate data, but in decimals. The unit is the one defined in the MO command.

Examples:

Syntax	Comments
<code>%SRX2Y3I2.0J3.0*%</code>	Opens an SR statement and starts block accumulation. When block accumulation is finished the block will be repeated 2 times along the X axis and 3 times along the Y axis. The step distance between X-axis repeats is 2.0 units. The step distance between Y-axis repeats is 3.0 units.
<code>%SRX4Y1I5.0J0*%</code>	Opens an SR statement and starts block accumulation. When block accumulation is finished the block will be repeated 4 times along the X axis with the step distance of 5.0 units. There are no repeats along the Y axis, so the step distance in the J is not used.
<code>%SR*%</code>	Closes the SR statement and repeats the previously accumulated block

The syntax is:

SR_statement = SR_open block SR_close;

**SR_open = '%' ('SR' 'X' positive_integer 'Y' positive_integer 'I'
decimal 'J' decimal) '*%';**

SR_close = '%' ('SR') '*%';

in_block_statement =

block =

```

{
| D01
| D02
| D03
| G01
| G02
| G03
| G75
| Dnn
| G04
| TO
| TD
| TA
| TF
| AD
| AM
| LP
| LM
| LR
| LS

```

```
| region_statement  
| AB_statement  
}*
```



Example:

```
G04 A block of two flashes is repeated 3x2 times*
%SRX3Y2I5.0J4.0*%
D13*
X123456Y789012D03*
D14*
X456789Y012345D03*
%SR*%
```

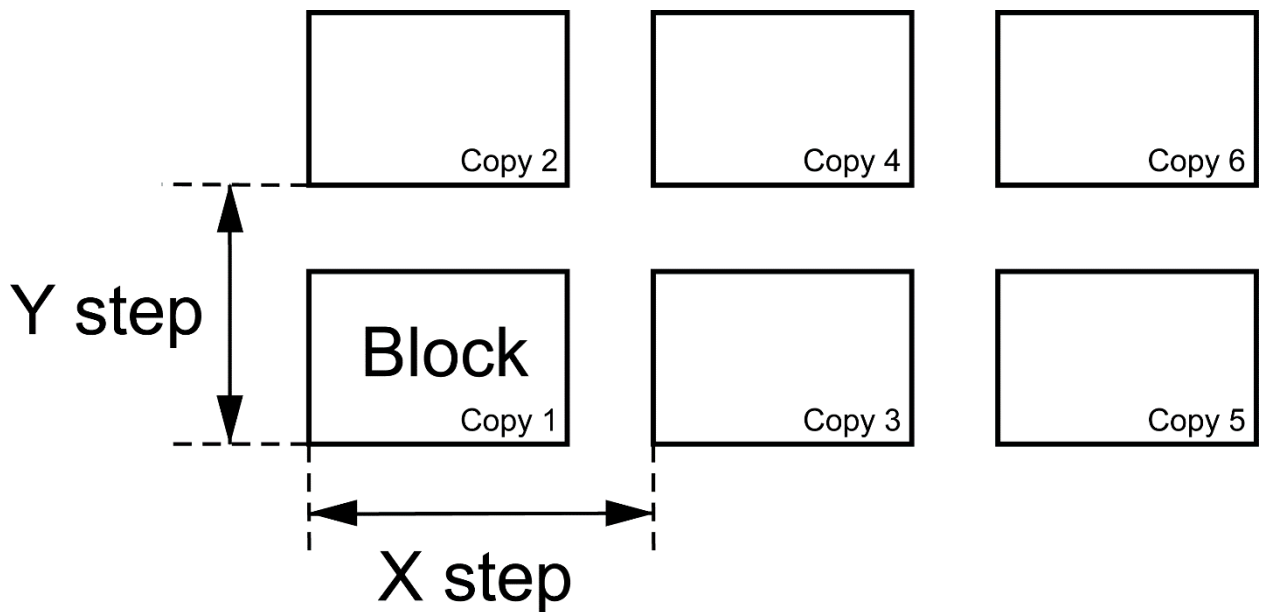

46. Blocks replication with SR command

Note that a block contains the graphical objects, not the Gerber source code. The graphical objects in each copy are always identical, even if the graphics state is modified during the SR statement.

The current point is undefined after an SR statement.

A file can contain multiple SR statements. The number of steps and the step distances can be different in X and Y. The number of repeats along an axis can be one; it is then recommended to use the step distance 0.

A step & repeat block can contain different polarities (LPD and LPC – see 4.9.2). A clear object in a block clears *all* objects beneath it, including objects outside the block. When repeats of blocks with both dark and clear polarity objects overlap, the step order affects the image; the correct step order must therefore be respected: step the complete block first in Y and then in X.

4.13 End-of-file (M02)

The M02 command indicates the end of the file. The syntax is as follows:

```
M02 = ('M02') '*';
```



Example:

```
M02*
```

The last command in a Gerber file *must* be the M02 command. As the CR and LF do not affect the interpretation of the file they are allowed but are not mandatory. *No other data is allowed after an M02.* Gerber readers are encouraged to give an error on a missing M02 as this is an indication that the file has been truncated.

Note that an M02 command *cannot* be issued *within* a block or region statement. They must first be explicitly closed.

4.14 Numerical Accuracy

The coordinates of all points and all geometric parameters (e.g. a diameter) have an exact numerical value. Graphical objects are therefore in principle defined with infinite precision with the exception of arcs, which are intrinsically slightly fuzzy (see 4.7.2.). A Gerber file specifies an image with infinite precision.

However, Gerber file writers cannot assume that file readers will process their files with infinite precision as this is simply impossible. *Nemo potest ad impossibile obligari*. This raises the question to what a Gerber file reader is held, and what a Gerber writer *can* assume.

4.14.1 Visualization

Gerber files are often used to *visualize* an image on a screen, a photoplotter, a direct imager. Visualization is unavoidably constrained by the limitations of the output device. Nonetheless, visualization must comply with the following rules:

- ❑ Each individual graphical object must be rendered within the stated accuracy of the output device.
- ❑ No spurious holes may appear - solid objects must be visualized solid.
- ❑ No spurious objects may appear.
- ❑ Zero-size objects are *not* visualized.
- ❑ Graphical objects can be rendered individually, without considering neighboring objects. In other words, each graphical object is handled individually, regardless of context.

It is intentionally not specified if rendering must be “fat” or “thin” - fat meaning that features below the device accuracy are blown up to be visible, thin meaning that they disappear.

These rules have several noteworthy consequences:

- ❑ Gerber objects separated by a very small gap may touch in the visualized image.
- ❑ Gerber objects that touch or marginally overlap may be separated by a gap in the visualized image.
- ❑ Gerber objects smaller or thinner than the device resolution may totally disappear in the visualized image.
- ❑ When what is intended to be a single object is broken down into simpler graphical objects, and these elementary objects do not sufficiently overlap, the resulting image may *not* be solid - it may have internal holes or even break up in pieces. To avoid these effects the best and most robust approach is not to break up the single object at all: the Gerber format has powerful primitives to create almost any shape with a single graphical object or possible a succession of dark and clear objects.

Construct files robustly.

4.14.2 Image Processing

Gerber files are processed for visualization but often also to complex image processing algorithms: e.g. etch compensation, design rule checks in CAM and so on. These algorithms perform long sequences of numerical calculations. Rounding errors unavoidably accumulate. Coordinates can move and object sizes can vary. The specification limits the allowed perturbation to $[-0.5\mu\text{m}, +0.5\mu\text{m}]$; furthermore coincident coordinates must remain coincident. The writer can assume that the perturbation is within this limit. Higher accuracy cannot be blindly assumed; if it is needed it must be checked that the applications downstream can handle

this. A file is therefore only robust if, under any allowed perturbation, it remains valid and represents the same image.

The perturbation has some noteworthy consequences:

- Contours that are not self-intersecting by a margin of $\leq 1\mu\text{m}$ can become self-intersecting under a valid perturbation. Such contours are therefore invalid; see section 4.10.3. Contours must be constructed robustly so that allowed processing perturbations do not turn an otherwise valid contour in a self-intersecting one. See 4.14.2. Consequently, points and segments that are not coincident must be separated by at least $1\mu\text{m}$. Furthermore, circular segments add their own intrinsic fuzziness, see 4.7.2. If any valid interpretation of the arc violates the requirement of $1\mu\text{m}$ separation the contour is invalid. Construct contours defensively. Observe sufficient clearances. Marginal contours can and do lead to problems.
- Objects that touch or overlap marginally can become separated under perturbation. This is important for electrical connection. An electrical connection that is realized by touching objects can get separated by a valid perturbation. Such marginal construction can be validly interpreted as either isolating or connecting. Make proper and robust electrical connections, with an overlap of the order of magnitude of at least the minimum conductor width.
- Arcs with end points separated by less than $1\mu\text{m}$ can toggle between very small or nearly 360 degrees under valid perturbations. Do not write such arcs.
- Avoid objects smaller than $1\mu\text{m}$.

Construct files robustly.

5 Attributes

5.1 Attributes Overview

Attributes add meta-information to a Gerber file. Attributes are akin to labels providing information about the file or features within them. Examples of meta-information conveyed by attributes are:

- ❑ The function of the file in the layer structure. Is the file the top solder mask, the bottom copper layer, ...?
- ❑ The function of a pad. Is the pad an SMD pad, or a via pad, or a fiducial, ...?

The attribute syntax provides a flexible and standardized way to add meta-information to a Gerber file, independent of the specific semantics or application.

Attributes do *not* affect the image. A Gerber reader will generate the correct image if it simply ignores the attributes.

Each attribute consists of an *attribute name* and an optional *attribute value*:

<Attribute> = <AttributeName>[,<AttributeValue>]

Attribute names follow the name syntax in section 3.4.5.

The attribute value consists of one or more comma-separated fields, see section 3.4.4.

<AttributeValue> = <Field>{,<Field>}*

There are three types of attributes by the *item* they attach to:

Attachment type	The item to which they attach meta-information
File attributes	Attach meta-information to the file as a whole.
Aperture attributes	Attach meta-information to an aperture or a region. Objects created by the aperture inherit the aperture meta-information
Object attributes	Attach meta-information to on object directly

There are two types of attributes by the *scope* of their use:

- ❑ *Standard attributes*. Standard attribute names, values and semantics are defined in this specification and are part of it. As they are standardized, they can exchange meta-information between all applications.
- ❑ *User attributes*. User attributes can be chosen freely by users to extend the format with custom meta-information. Use custom attributes only for unequivocally defined machine-readable information, use G04 for mere human-readable comments.

In accordance with the general rule in 3.4.5 standard attribute names *must* begin with a dot '.' while user attribute names *cannot* begin with a dot. The dot, if present, is part of the attribute name and indicates that it is a standard attribute whose syntax and semantics are defined in section 5.6.



Example of a user attributes:

%TFMyAttribute, Yes*%

%TFZap*%

%TFZonk*%

The following commands govern attributes. (They start with a T as the more obvious A is already taken by the aperture commands.)

Command	Description	Section
TF	Attribute file. Set a file attribute.	5.2
TA	Attribute aperture. Add an aperture attribute to the dictionary or modify it.	5.3
TO	Attribute object. Add an object attribute to the dictionary or modify it.	5.4
TD	Attribute delete. Delete one or all attributes in the dictionary.	5.5

The syntax is as follows. (The attribute names follow the syntax of name):

```
attribute_value = field {',' field}*;  
TF = '%TF' file_attribute_name [',' attribute_value] '*%';  
TA = '%TA' aperture_attribute_name [',' attribute_value] '*%';  
TO = '%TO' object_attribute_name [',' attribute_value] '*%'; TD = '%TD'  
  [  
    | file_attribute_name  
    | aperture_attribute_name  
    | object_attribute_name  
  ]  
  '*%';
```

An *attribute dictionary* is maintained during the processing of a Gerber file. Dictionary entries consist of the attribute name, its domain, and its value. The attribute name is the key to the entry; the name must therefore be unique. (For example, an aperture or object attribute cannot share the same name.)

The current aperture dictionary is defined after each command by the following rules:

- ❑ Initially the attribute dictionary is empty
- ❑ File attributes are added with the TF command
- ❑ Aperture attributes are added or updated with the TA command
- ❑ Object attributes are added or updated with the TO command
- ❑ Attributes are deleted with the TD command

When an aperture or a graphical object is created all attributes with the proper domain in the dictionary at that time are attached to it. They are fixed and cannot be changed.

Attribute commands are not allowed *within* a region statement, see 4.10.2.

In the following example the command TF defines an attribute with name “.FileFunction” and with value composed of the two fields: “Soldermask,Top”.



Example:

```
%TF.FileFunction,Soldermask,Top*%
```

5.1.1 Comment attributes

There is legacy software that fails on files with attribute commands. (This software is then non-conforming.) To avoid such problems attributes can also be expressed with standardized comments, see 4.1.

For example,

```
TA.AperFunction,SMDPad,CuDef*
```

can be written as

```
G04 #@! TA.AperFunction,SMDPad,CuDef*
```

Both have exactly the same meaning.

5.2 File Attributes (TF)

File attributes provide meta-information about entire files.

The semantics of a file attribute specifies where it must be defined, typically in the header of the file. File attributes are immutable. **They cannot be redefined or deleted.**

File attributes are set with the uppercase TF command with the following syntax

```
<TF command> = %TF<AttributeName>[,<AttributeValue>]*%
<AttributeValue> = <Field>
```

The attribute name must follow the syntax in section 3.4.5, fields the syntax in 3.4.4. The name is unique.



Example:

```
%TF.FilePolarity,Negative*%
```

5.3 Aperture Attributes (TA)

An *aperture attribute* is attached to an aperture or a region. They are a method to assign attributes to graphical objects in bulk: all objects that are created with an aperture inherit its attributes; for example, a via attribute on an aperture means that all pads flashed with this aperture are via pads. Providing information about graphical objects via their apertures is elegant, compact and efficient. As region objects are created without intermediary aperture, aperture objects can be assigned to regions directly.

The TA command adds an aperture attribute into the attributes dictionary. It has the following syntax:

```
<TA command> = %TA<AttributeName>[,<AttributeValue>]*%
<AttributeValue> = <Field>
```

The attribute name must follow the syntax in section 3.4.5, fields the one in 3.4.4. The name must be unique. The value of an aperture attribute can be modified by a new TA with the same attribute name.

The example below defines several attributes.



Example:

```
%TA.AperFunction,ComponentPad*%
%TAMyApertureAttributeWithValue,value*%
%TAMyApertureAttributeWithoutValue*%
```

In the next example the aperture value is initially set to `ComponentPad` and later overruled to `ViaPad`.



Example:

```
%TA.AperFunction,ComponentPad*%
...
%TA.AperFunction,ViaPad*%
```

When an AD or an AB command creates an aperture all aperture attributes then in the attribute dictionary are attached to it. Once an aperture is defined its attributes cannot be changed.

5.3.1 Aperture Attributes on Regions

Counter-intuitively, aperture attributes can be attached to regions. When a G36/G37 creates a region all aperture attributes in the dictionary are attached to it, in the same way as they are attached to an aperture created with an AD command. A way to view this is that the G36 command creates a virtual region aperture and attaches attributes to it in the same way as an AD. Regions effectively function as single-use apertures that are flashed and immediately forgotten when the region definition is completed.

Aperture attributes on regions are necessary. Aperture attributes are an efficient way to attach properties to large numbers of draw, arc or flash objects. Sometimes the same property must be attached to regions. For example, both tracks – draws and arcs– and copper pours – regions - often have the ‘Conductor’ function. After all, regions are objects as any other, that purely for syntactic reasons do not have an aperture associated. The first paragraph gives a mechanism to associate the aperture attributes to regions.



Example: Define a copper pour as a region

```
%TA.AperFunction,Conductor*%
G36*
X118151529Y-78573554D02*
G01*
X118230607Y-78626393D01*
X118283446Y-78705471D01*
X118302000Y-78798750D01*
X118302000Y-79286250D01*
...
X118151529Y-78573554D01*
G37*
```

For the avoidance of doubt: regions take the aperture attributes from the dictionary, not from the current aperture.

5.4 Object Attributes (TO)

An *object attribute* is attached to graphical objects. When a D01, D03 or region statement (G36/G37) creates an object all object attributes in the attribute dictionary are attached to it. As attribute commands are not allowed inside a region statement, *all* regions created by that statement have the same object attributes. Once attached to an object they cannot be changed.

The TO command adds an object attribute into the attributes dictionary. It has the same syntax as the TF command:

<TO command> = %TO<AttributeName>[,<AttributeValue>]*%

<AttributeValue> = <Field>

The attribute name must follow the syntax in section 3.4.5, fields the one in 3.4.4. The name is unique. The value of an object attribute can be modified by a new TO command with the same attribute name.



Example:

%T.O.C, R6*%

5.5 Delete Attribute (TD)

The TD command deletes one or all aperture or object attributes from the attributes dictionary. (File attributes are immutable and are not deleted.)

<TD command> = %TD[<AttributeName>]*%;

The <AttributeName> is the name of the attribute to delete. If omitted, all aperture and object attributes in the dictionary are deleted.

Note that an attribute remains attached to apertures and objects to which it was attached before it was deleted from the dictionary.

5.6 Standard Attributes

5.6.1 Overview

Name	Usage	Section	Attached to
.Part	Identifies the part the file represents, e.g. a single PCB	5.6.2	File
.FileFunction	Identifies the file's function in the PCB, e.g. top copper layer	5.6.3	File
.FilePolarity	Positive or Negative. This defines whether the image represents the presence or absence of material.	5.6.4	File
.SameCoordinates	All files in a fabrication data set with this attribute use the same coordinates. In other words, they align.	5.6.5	File
.CreationDate	Defines the creation date and time of the file.	5.6.6	File
.GenerationSoftware	Identifies the software creating the file.	5.6.7	File
.ProjectId	Defines project and revisions.	5.6.8	File
.MD5	Sets the MD5 file signature or checksum.	5.6.9	File
.AperFunction	Function of objects created with the apertures, e.g. SMD pad	5.6.10	Aperture
.DrillTolerance	Tolerance of drill holes	5.6.11	Aperture
.FlashText	Provides the source text and font for flashes representing text..	5.6.12	Aperture
.N	The CAD net name of a conducting object, e.g. Clk13.	5.6.13	Graphical object
.P	The pin number (or name) and reference descriptor of a component pad on an outer layer, e.g. IC3,7.	5.6.14	Graphical object
.C	The component reference designator linked to an object, e.g. C2.	5.6.15	Graphical object
.Cxxx	A range of component characteristics, e.g. .CRot,90.	5.6.16	Graphical object

Standard attributes

The standard attributes are needed by PCB fabrication and must be included in the PCB data sent from design to fabrication. For example, the fabricator needs to know where the via pads are to handle the solder mask properly. The standard attributes transfer this design intent from CAD to CAM in an unequivocal and standardized manner. This is sometimes rather grandly called “adding intelligence to the image”. Without standard attributes the design intent must be gathered from various documents, unwritten rules, conversations, or reverse engineering, with serious risks of errors and delays.

Use standard attributes as comprehensively as possible. If you cannot provide *all* the attributes or are unsure of their use, provide at least all the attributes you are comfortable with. Partial information is better than no information. For professional PCB production the bare minimum attributes are .FileFunction and .FilePolarity – without these even the images are undefined.

Note that standard attribute values typically contain a value “Other” for requirements not yet foreseen in the specification. New values as the need arises to minimize the use of “Other”.

If you have suggestions for new standard attributes, please contact Ucamco at gerber@ucamco.com . Authors will be properly acknowledged for suggestions that make it to the standard.



Warning: Do not invent your own standard attribute names (names starting with a dot). This would defeat the benefits of standardization. User attributes cater to requirements not covered by the standard attributes. Feel free to invent any user attribute you wish.

5.6.2 .Part

The value of the .Part file attribute identifies which part is described. The attribute – if present - must be defined in the header.

.Part value	Usage
Single	Single PCB
Array	A.k.a. customer panel, assembly panel, shipping panel, biscuit
FabricationPanel	A.k.a. working panel, production panel
Coupon	A test coupon
Other, <mandatory field>	None of the above. The mandatory field informally indicates the part

.Part file attribute values



Example:

```
%TF.Part,Array*%
```

5.6.3 .FileFunction

The .FileFunction file attribute identifies the function of the file in the PCB layer structure. Of all the attributes it is the most important.



Example:

```
%TF.FileFunction,Copper,L1,Top*%
```

The attribute must be defined in the header.

The existence of a file function does not mean that it must be included in each PCB fabrication data set. Include only the files that are needed: no more, no less.

The file functions are designed to support all file types in current use. If a type you need is missing please contact us at gerber@ucamco.com.

Data layers	
.FileFunction value	Usage
<code>Copper,L<p>, (Top Inr Bot) [,<type>]</code>	<p>A conductor or copper layer.</p> <p>L<p> (p is an integer>0) specifies the physical copper layer number. Numbers are consecutive. The top layer is always L1. (L0 does <i>not</i> exist.) The mandatory field (<i>Top Inr Bot</i>) specifies it as the top, an inner or the bottom layer; this redundant information helps in handling partial data. The specification of the top layer is “<i>Copper,L1,Top[,type]</i>”, of the bottom layer of an 8 layer job it is <i>Copper,L8,Bot[,type]</i></p> <p>The top side is the one with the through-hole components, if any.</p> <p>The optional <type> field indicates the layer type. If present it must take one of the following values: <i>Plane, Signal, Mixed</i> or <i>Hatched</i>.</p>
<code>Plated,i,j, (PTH Blind Buried) [,<label>]</code>	<p>Plated drill/rout data, span from copper layer i to layer j. The from/to order is not significant. The (PTH Blind Buried) field is mandatory.</p> <p>The label is optional. If present it must take one of the following values: <i>Drill, Rout</i> or <i>Mixed</i>.</p>
<code>NonPlated,i,j, (NPTH Blind Buried) [,<label>]</code>	<p>Non-plated drill/rout data, span from copper layer i to layer j. The from/to order is not significant. The (NPTH Blind Buried) field is mandatory.</p> <p>The label is optional. If present it must take one of the following values: <i>Drill, Rout</i> or <i>Mixed</i>.</p>

Profile, (P NP)	<p>A file containing the board profile (or outline) and only the board profile. Such a file is mandatory in a PCB fabrication data set. See 6.5.</p> <p>The mandatory (P NP) label indicates whether board is edge-plated or not.</p>
Soldermask, (Top Bot) [, <index>]	<p>Solder mask or solder resist. Not to be confused with the paste layer.</p> <p>Usually the image represents the solder mask <i>openings</i>; it then has negative polarity, see 5.6.4.</p> <p>The optional field is only needed when there is more than one solder mask on one side – top or bottom. The integer <index> then numbers the solder masks from the PCB side outwards, starting with 1 for the mask directly on the copper. Usually there is only one solder mask on a side, and then <index> is omitted. An example with two top solder masks:</p> <p>Soldermask, Top, 1 ← Mask on the copper</p> <p>Soldermask, Top, 2 ← Mask on the first mask</p>
Legend, (Top Bot) [, <index>]	<p>A legend is printed on top of the solder mask to show which component goes where. A.k.a. ‘silk’ or ‘silkscreen’.</p> <p>See Soldermask for the usage of <index>.</p>
Component, L<p>, (Top Bot)	<p>A layer with component information.</p> <p>L<p> The integer p is the copper layer number to which the components described in this file are attached. (Top Bot) indicates if the components are on top, upwards, or on the bottom, downward, of the layer to which they are attached. This syntax caters for embedded components.</p> <p>For jobs without embedded components there is an intentional redundancy.</p>
Paste, (Top Bot)	<p>Locations where solder <i>paste</i> must be applied. This is typically used to make the stencil. Do not confuse it with the solder <i>mask</i> or solder <i>resist</i>.</p>
Glue, (Top Bot)	<p>Glue spots to fix components prior to soldering.</p>
Carbonmask, (Top Bot) [, <index>]	<p>See Soldermask for the usage of <index>.</p>
Goldmask, (Top Bot) [, <index>]	<p>See Soldermask for the usage of <index>.</p>

Heatsinkmask, (Top Bot) [, <index>]	See Soldermask for the usage of <index>.
Peelablemask, (Top Bot) [, <index>]	See Soldermask for the usage of <index>.
Silvermask, (Top Bot) [, <index>]	See Soldermask for the usage of <index>.
Tinmask, (Top Bot) [, <index>]	See Soldermask for the usage of <index>.
Depthrout, (Top Bot)	Area that must be routed to a given depth rather than going through the whole board.
Vcut [, (Top Bot)]	Contains the lines that must be v-cut. (V-cutting is also called scoring.) If the optional attachment (Top Bot) is not present the scoring lines are identical on top and bottom – this is the normal case. In the exceptional case scoring is different on top and bottom two files must be supplied, one with Top and the other with Bot.
Viafill	Contains the via's that must be filled. It is however recommended to specify the filled via's with the optional field in the .AperFunction ViaDrill.
Pads, (Top Bot)	A file containing only the pads (SMD, BGA, component, ...). Not needed in a fabrication data set.
Other, <mandatory field>	Another data layer then the ones above. The mandatory field informally describes it.
Drawing layers	
.FileFunction value	Usage
Drillmap	A drawing with the locations of the drilled holes. It often also contains the hole sizes, tolerances and plated/non-plated info.
FabricationDrawing	An auxiliary drawing with additional information for the fabrication of the bare PCB: the location of holes and slots, the board outline, sizes and tolerances, layer stack, material, finish, etc.
Vcutmap	A drawing with v-cut or scoring information.
AssemblyDrawing, (Top Bot)	An auxiliary drawing with the locations and reference designators of the components. It is mainly used in PCB assembly.
ArrayDrawing	A drawing of the array (biscuit, assembly panel, shipment panel, customer panel).

OtherDrawing,<mandatory field>	Any other drawing than the five ones above. The mandatory field describes its topic.
--------------------------------	---

.FileFunction attribute values



Examples. File functions of a four layer board (One for each Gerber file):

`%TF.FileFunction,Legend,Top*%`

`%TF.FileFunction,Soldermask,Top*%`

`%TF.FileFunction,Copper,L1,Top*%`

`%TF.FileFunction,Copper,L2,Inr,Plane*%`

`%TF.FileFunction,Copper,L3,Inr,Plane*%`

`%TF.FileFunction,Copper,L4,Bot*%`

`%TF.FileFunction,Soldermask,Bot*%`

`%TF.FileFunction,NonPlated,1,4,NPTH,Drill*%`

`%TF.FileFunction,NonPlated,1,4,NPTH,Rout*%`

`%TF.FileFunction,Plated,1,4,PTH*%`

`%TF.FileFunction,Profile,NP*%`

`%TF.FileFunction,Drillmap*%`

5.6.4 .FilePolarity

The .FilePolarity specifies whether the image represents the *presence or absence* of material.

The .FilePolarity attribute does *not* change the image - no attribute does. It changes the interpretation of the image. For example, in a copper layer in positive polarity a round flash generates a copper *pad*. In a copper layer in negative polarity it generates a *clearance*.

The .FilePolarity attribute must be defined in the header.

.FilePolarity value	Usage
Positive	The image represents the <i>presence</i> of material (recommended)
Negative	The image represents the <i>absence</i> of material

.FilePolarity attribute values



Example 1:

```
%TF.FileFunction,Copper,L2,Inr,Plane*%
%TF.FilePolarity,Positive*%
```



Warning: *Solder mask layers are nearly always negative.* Solder mask layers typically represent the mask openings, or the *absence* of solder mask, and are therefore *negative*. This may be counter intuitive as such masks are so ubiquitous to be regarded as normal, and positive is also regarded as normal.



Example2:

```
%TF.FileFunction,Soldermask,Top*%
%TF.FilePolarity,Negative*%
```

Drill and rout files indicate where the drill bit hits and are therefore always positive. It is recommended output copper layers in positive. Power/ground planes in negative made sense in the 1970s and 1980s to get around the limitations in the vector photoplotters of that age but there is no longer any reason for negative today.

5.6.5 .SameCoordinates

All layers in a PCB fabrication data set must use the same coordinate system – the origin and orientation of the axes must be the same. Data in different layers then aligns: the pads, drill holes, pads and solder mask openings of a pad stack all have the same coordinates.

This is obvious but unfortunately layers sometimes layers are flipped or origins shifted. The fabricator consequently cannot trust the incoming data and must reverse-engineer the layer alignment. This uncertainty can lead to scrap with boards where wrong alignment is not obvious, such as very symmetric or HF boards.

The .SameCoordinates attribute tells the fabricator that the alignment is correct.

The attribute must be defined in the header. The syntax is as follows:

```
%TF.SameCoordinates[,<ident>]*%
```



Example – without ident:

```
%TF.SameCoordinates*%
```

If this attribute is present in a number of Gerber files in a PCB fabrication data set then these files are in alignment with each other.



Example – with a GUID as ident:

```
%TF.SameCoordinates,f81d4fae-7dec-11d0-a765-00a0c91e6bf6*%
```

The ident is optional. Its purpose is the following. Files in the fabrication data can be output at different times, and in between the CAD origin may have changed. In that situation simply outputting the attribute would wrongly signal the layers do align. The ident distinguishes between these different coordinate systems at output time. Files with the same ident align, files with different idents don't necessarily. The ident can be freely chosen, but the GUID is recommended. When all files have the same coordinates, the ident is not needed.

Note that all data files must align anyhow, attribute or no attribute.

5.6.6 .CreationDate

The .CreationDate file attribute identifies the moment of creation of the Gerber file.

The attribute – if present - must be defined in the header. The attribute value must conform to the full version of the ISO 8601 date and time format, including the time zone. A formally defined creation date can be helpful in tracking revisions – see also 5.6.8



Example:

```
%TF.CreationDate,2015-02-23T15:59:51+01:00*%
```

5.6.7 .GenerationSoftware

The .GenerationSoftware file attribute identifies the software that generated the Gerber file. The field <vendor> identifies the organization that supplies the generating software to its users; this can be a commercial company, an open-source organization, etc.

The attribute – if present - must be defined in the header. The syntax is as follows:

```
%TF.GenerationSoftware,<vendor>,<application>,<version>*%
```



Example:

```
%TF.GenerationSoftware,Ucamco,UcamX,2017.04*%
```

5.6.8 .ProjectId

Usually a Gerber file is part of a PCB project with a sequence of revisions. The purpose of the .ProjectId file attribute is to uniquely identify project and revision. This is especially important to check whether all files belong to the same revision. By its nature, these values can only be defined by the creator of the project and revision.

The attribute – if present - must be defined in the header. The syntax is as follows:

```
%TF.ProjectId,<Name>,<GUID>,<Revision>*%
```

The field <Name> is the id or reference used by the design owner, <GUID> defines the project using a global unique ID and <Revision> specifies its revision. All parameters must conform to the field syntax, see 3.4.4. The <GUID> is a field conforming to RFC4122 version 1 or version 4.



Examples:

```
%TF.ProjectId,My PCB,f81d4fae-7dec-11d0-a765-00a0c91e6bf6,2*%
```

```
%TF.ProjectId,project#8,68753a44-4D6F-1226-9C60-0050E4C00067,/main/18*%
```

5.6.9 .MD5

The .MD5 file attribute sets a file signature (checksum, hash, digest) that uniquely identifies the file and provides a high degree of security against accidental modifications.

The .MD5 checksum is not intended for CAD to CAM data transfer which is probably sufficiently protected by the checksum of the zip, but rather for individual files used within fabrication, with a bewildering collection of legacy systems and protocols, and where file transmission errors sometimes occur.

The 128 bit signature is calculated with the MD5 algorithm and expressed as a 32 digit hexadecimal number (see <https://en.wikipedia.org/wiki/MD5>). The signature is calculated over the bits from the beginning of the file up to but excluding the .MD5 file attribute command itself. Note that this excludes the closing M02*. The complete .MD5 file attribute command, with both '%' and '*', is excluded. CR and LF are excluded from signature calculation as they do not affect the interpretation of the file but may be altered when moving platforms.

The signature, if present, must be put at the end of the file, just before the closing M02*. Thus the file can be processed in a single pass.



Example:

Consider the following Gerber file segment, without checksum:

```
...
D11*
X1500000Y2875000D03*
X2000000D03*
D19*
X2875000Y2875000D03*
M02*
```

As the CR and LF characters are skipped the checksum is taken over the following data:

```
...D11*X1500000Y2875000D03*X2000000D03*D19*X2875000Y2875000D03*
```

With the checksum the file then becomes:

```
...
D11*
X1500000Y2875000D03*
X2000000D03*
D19*
X2875000Y2875000D03*
%TF.MD5,6ab9e892830469cdf7e3e346331d404*%
M02*
```

<- Excluded from the MD5

<- Excluded from the MD5

The following Perl script specifies precisely how the .MD5 is calculated:

```
#script expects one parameter (original Gerber X2 file)
use Digest::MD5;
local $_ = shift;
local *IN;
my $content;

local $/;
open(IN, "<$_") or die "Cannot open $_ due to $!";
$content = <IN>;          #read file to the variable
close IN;
$content =~ s/\r|\n//g; #remove all CRLF (end of line) characters
$content =~ s/M02\*//;  #remove M02 from the end of file

#calculate MD5
$md5 = Digest::MD5->new; #init MD5
$md5->add($content);     #send content of the file to MD5 engine

print "Add 2 following lines to the Gerber file, please.\n";
print "%TF.MD5,";
print $md5->hexdigest;   #print correct MD5 hash
print "*%\nM02*\n\n";
```

5.6.10 .AperFunction

The .AperFunction aperture attribute defines the *function* or purpose of an aperture, or rather the graphical objects created with it. PCB CAM needs to know the function of graphical objects, especially pads. If this is not possible define the function of all attributes then at least define if for those where you can - partial information is better than no information. The bare minimum is to identify via pads: the PCB fabricator must know where the via pads are.

One function, one aperture. Objects with different functions must be created with different apertures, even if they have the same shape and size. Apertures with objects with mixed functions are devilishly hard to handle in CAM: the CAM engineer must check each individual object to determine which action to take. It is far more efficient and secure to do this per aperture. This also applies to drill tools: suppose via and component holes have the same size; vias and component holes need different tool compensations; when they are separate tools the compensation can be done per tool; when they use the same tool the CAM engineer must laboriously go over each drill to determine whether it is a via or a component hole, and compensate accordingly.

Regions. Counterintuitively, regions can carry aperture attributes, see 5.3.1. Use .AperFunction to define the function of the regions.

Painted pads and painted copper pours (aka vector-fill). How to set attributes on painted pads or copper pours? Simple. Replace the painting with proper flashes or regions and then proceed as in this specification.

The .AperFunction values are defined in the tables below. Attribute values typically can only be used on specific layers - for example, SMDPad can only be used on outer copper layers.

Drill and rout layers	
.AperFunction value	Usage
<p>ViaDrill[, <IPC-4761>] <IPC-4761>= (Ia Ib IIa IIb IIIa IIIb IVa IVb V VI VII None)</p>	<p>A via hole, a plated hole whose <i>sole</i> function is to connect different layers, where there is no intention to insert component leads or mechanical objects.</p> <p>An optional field specifies the via protection according to IPC-4761</p>
<p>BackDrill</p>	<p>A hole to remove plating over a sub-span by drilling that sub-span with a larger diameter.</p>
<p>ComponentDrill [, PressFit]</p>	<p>A hole that is used for the attachment and/or electrical connection of component terminations, including pins and wires, to a printed board. (Per IPC-T-50). The attribute applies to drill holes and rout slots.</p> <p>The optional label PressFit indicates drill holes for press fit leads. Press fit leads are pressed in properly sized plated-through holes to realize the electrical contact. The label can only be applied on PTH holes.</p> <p>See also ComponentPad.</p>
<p>MechanicalDrill [, (Tooling Breakout Other)]</p>	<p>A hole with mechanical function (registration, screw, etc.) It applies to drill holes and rout slots. The specifier is optional. If present it can take one of the following values:</p> <ul style="list-style-type: none"> • Tooling: Holes placed on a PCB or a panel of PCBs for registration and hold-down purposes during the manufacturing process.. Also called mounting holes. • BreakOut: Non-plated holes forming a break-out tab used in break routing. <div style="text-align: center;">  </div> <ul style="list-style-type: none"> • Other <p>Example: .AperFunction, MechanicalDrill, Breakout .AperFunction, MechanicalDrill</p>

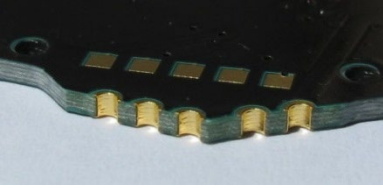
CastellatedDrill	<p>Plated holes cut- through by the board edge; used to join PCBs.</p>  <p>Image courtesy Eurocircuits.</p>
OtherDrill, <mandatory field>	<p>A hole, but none of the above. The mandatory field informally describes the type.</p>
Copper layers	
.AperFunction value	Usage
ComponentPad	<p>A pad associated with a <i>component hole</i>. The pads around a ComponentDrill <i>on all layers</i> take the value ComponentPad although indeed on inner layers they only have a via function. In other words, the pad attribute value follows the drill tool attribute value.</p> <p>Only for through-hole components; SMD and BGA have their own dedicated type.</p> <p>See also ComponentDrill.</p>
SMDPad, (CuDef SMDef)	<p>A pad belonging to the footprint of an <i>SMD component</i>, whether the corresponding lead is connected or not. Applies only for the normal electrical pads, thermal pads have their own function; see HeatsinkPad.</p> <p>BGA pads which have their own type.</p> <p>The specifier (CuDef SMDef) is <i>mandatory</i>. CuDef stands for <i>copper defined</i>; it is by far the most common SMD pad; the copper pad is completely free of solder mask; the area to be covered by solder paste is defined by the copper pad. SMDef stand for <i>solder mask defined</i>; the solder mask overlaps the copper pad; the area to be covered by solder paste is defined by the solder mask opening and not by the copper pad. (CuDef is sometimes rather awkwardly called <i>non solder mask defined</i>.)</p> <p>Only applicable for outer layers.</p> <p>When an SMD pad contains a via hole the pad where the SMD is soldered, on the outer layer with the SMD, is SMDPad, all other pads in the stack are ViaPad. If the SMD pad contains an embedded via pad, as it should, then that embedded pad is of course ViaPad.</p>

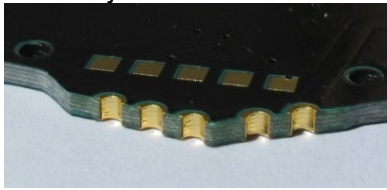
<p>BGAPad, (CuDef SMDef)</p>	<p>A pad belonging to the footprint of a <i>BGA component</i>, whether the corresponding lead is connected or not.</p> <p>The specifier (CuDef SMDef) is <i>mandatory</i>. CuDef stands for <i>copper defined</i>, SMDef for <i>solder mask defined</i>; see SMDPad.</p> <p>Only applicable for outer layers.</p> <p>When a BGA pad contains a via hole the pad where the BGA is soldered is BGAPad, all other pads in the stack are ViaPad. If the BGA pad contains an embedded via pad, as it should, then that embedded pad is of course ViaPad.</p>
<p>ConnectorPad</p>	<p>An edge connector pad.</p> <p>Only applicable for outer layers.</p>
<p>HeatsinkPad</p>	<p>Heat sink or thermal pad, typically for SMDs</p>
<p>ViaPad</p>	<p>A via pad. It provides a ring to attach the plating in the barrel. This is reserved for pads that have <i>no other function</i> than making the connection between layers: For example component pads often also have a via function however they must have the Component function.</p>
<p>TestPad</p>	<p>A test pad. Only applicable for outer layers.</p> <p>Sometimes a test pad is drilled and also has a via function, to save space. Such a pad <i>must</i> be specified as test pad. (It is clear from the construction that it has a via function, but the fabricator must know it is a test pad, and this is not obvious. Similarly, a component pad can also function as a via, but it remains a component pad.)</p>
<p>CastellatedPad</p>	<p>Pads on plated holes cut- through by the board edge; used to join PCBs.</p>  <p style="text-align: right; font-size: small;">Image courtesy Eurocircuits.</p>
<p>FiducialPad , (Local Global Panel)</p>	<p>A fiducial pad.</p> <p>The specifier (Local Global Panel) is <i>mandatory</i>. Local fiducials locate the position of an individual component on a PCB, global fiducials locate a PCB on the assembly panel, and panel fiducials locate an assembly panel on the fabrication panel.</p>
<p>ThermalReliefPad</p>	<p>A thermal relief pad connected to the surrounding copper while restricting heat flow.</p>

WasherPad	A pad around a non-plated hole without electrical function. Several applications, e.g. a pad that strengthens the PCB where fixed with a bolt – hence the name washer.
AntiPad	A pad with clearing polarity (LPC) creating a clearance in a plane. It makes room for a drill pass without connecting to the plane. Note that setting the AntiPad attribute itself has no effect on the image, and therefore does not turn the pad into LPC as a side effect– this must be done explicitly by an %LPC*% command.
OtherPad, <mandatory field>	A pad not specified above. The mandatory field informally describes the type.
Conductor	Copper whose function is to connect pads or to provide shielding, typically tracks and copper pours such as power and ground planes. Conductive copper pours must carry this attribute.
EtchedComponent	Etched components are embedded inductors, transformers and capacitors which are etched into the PCB copper. The following illustration shows two etched inductors:  For the CAD netlist these are components like others: the net names are different on both sides. (However, for bare-board electrical test they may be conducting copper and connect the net on both sides.)
NonConductor	Copper that does not serve as a conductor, that has no electrical function; typically text in the PCB such as a part number and version. This attribute can only be applied to copper, not to drawing elements in a copper layer; see also NonMaterial and Profile.
CopperBalancing	Copper pattern added to balance copper coverage for the plating process.
Border	The copper border of a production panel.
OtherCopper, <mandatory field>	Indicates another function. The mandatory field informally describes it.

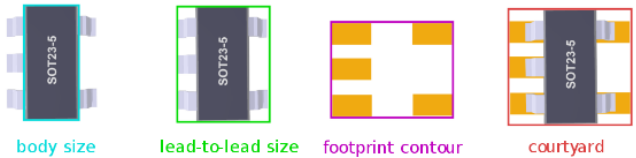
Component layers	
.AperFunction value	Usage
ComponentMain	<p>This aperture is flashed at the centroid of a component. A .C object attribute <i>must</i> be attached to the flash to identify the reference descriptor. Optional .Cxxx object attributes define the characteristics of the component. See also 6.9.</p> <p>The following aperture must be used:</p> <p style="margin-left: 40px;">%ADDnnC,0.300*% (mm) %ADDnnC,0.012*% (in)</p> <p>nn is an aperture number, an integer ≥ 10.</p>
ComponentOutline, <type> <type>= (Body Lead2Lead Footprint Courtyard)	<p>This aperture draws the component outline. There are four different outline types:</p> <div style="text-align: center;">  <p style="display: flex; justify-content: space-around; font-size: small;"> body size lead-to-lead size footprint contour courtyard </p> </div> <p>Different outlines for one component are allowed. A .C object attribute <i>must</i> be attached to each draw/arc to identify the reference descriptor. See also 6.9.</p> <p>The outline is drawn with a sequence of connected draws and arcs (D01). They are said to connect only if they are defined consecutively, with the second starting where the first one ends. Thus, the order in which they are defined is significant. An outline is closed: the end point of the last draw/arc must coincide with the start point of the first. Outlines cannot self-intersect. The following apertures must be used:</p> <p style="margin-left: 40px;">%ADDnnC,0.100*% (mm) %ADDnnC,0.004*% (in)</p>

ComponentPin	<p>This aperture identifies the pin (or lead) locations. The coordinates in the flash command (D03) indicate the location of the component pins (leads). A .P object attribute <i>must</i> be attached to each ComponentPin flash to identify the reference descriptor and pin number; the .N object attribute <i>may</i> be attached. See also 6.9.</p> <p>For the key pin, typically pin "1" or "A1", the following diamond shape aperture <i>must</i> be used:</p> <pre>%ADDnnP,0.360X4X0.0*% (mm) %ADDnnP,0.014X4X0.0*% (in)</pre> <p>For all other pins the following small circle aperture <i>must</i> be used:</p> <pre>%ADDnnC,0.1*% (mm) %ADDnnC,0.004*% (in)</pre> <p>This clearly identifies the key pin and visualizes the other pins without cluttering the image.</p>
All data layers	
.AperFunction value	Usage
Profile	Identifies the draws and arcs that exactly define the profile or outline of the PCB. This is the content of the Profile file but can also be present in other layers. See 6.5
NonMaterial	The attribute value NonMaterial identifies objects that do not represent physical material but drawing elements. NonMaterial is only meaningful on files that define the pattern of physical layers of a PCB such as copper layers or solder mask. Such files unfortunately sometimes not only contain data representing material but also drawing elements such as a frame and a title block. (Note: drawing elements should not be mixed with pattern data, see 6.6.2. Use separate drawing layers for drawings.)
Material	<p>Identifies the proper part of the data file.</p> <p>Solder masks are traditionally negative. The image represents the solder mask openings. The apertures take the value 'Material' – they define solder mask material, but in a negative way.</p> <p>For copper and drill layers Material is split into more specific functions such as SMD pad. Use the specific functions when available rather than 'Material'.</p>

Other, <mandatory field>	<p>The value 'Other' is to be used if none of the values above fits. By putting the value 'Other' rather than crudely omitting the attribute it is made explicit that the value is none of the above – an omitted attribute can be one of the above. Certainly do not abuse existing values by horseshoeing an attribute with a vaguely similar function into that value that does not fit perfectly – keep the identification clean by using 'Other'.</p> <p>The mandatory field informally describes the aperture function.</p>
--------------------------	---

.AperFunction attribute values

Functions on extra layers. The solder mask, paste and other extra layers openings *cannot* take pad values. Pad values are reserved for copper layers. The solder mask openings and paste pads take their function from the underlying copper pads. The reason for this is that a single solder mask opening may have multiple underlying copper pads – e.g. an SMD pad with an embedded via pad - and hence multiple functions. Consequently, solder mask openings have the aperture function ‘Material’. (This is somewhat a misnomer in this context as solder masks are usually negative, and the presence of image indicates therefore the absence of material)

The following file creates a circular hole in the solder mask. In negative file polarity the image represents the absence of material.

```
%FSLAX36Y36*%
%MOMM*%
%TF.FileFunction,Soldermask,Top*%
%TF.Part,Single*%
%TF.FilePolarity,Negative*%
%TA.AperFunction,Material*%
%ADD10C,2.54*%
%LPD*%
D10*
X123500000Y12500D0003*
...
M02*
```

If the file polarity is positive an otherwise identical file creates a circle consisting of solder mask.

```
%FSLAX36Y36*%
%MOMM*%
%TF.FileFunction,Soldermask,Top*%
%TF.Part,Single*%
%TF.FilePolarity,Positive*%
%TA.AperFunction,Material*%
%ADD10C,2.54*%
%LPD*%
D10*
X123500000Y12500000D03*
...
M02*
```

5.6.11 .DrillTolerance

.DrillTolerance defines the plus and minus tolerance of a drill hole end diameter. Both values are positive decimals expressed in the MO units. The attribute value has the following syntax:

<plus tolerance>,<minus tolerance>



Examples:

```
%TA.DrillTolerance,0.01,0.005*%
```

5.6.12 .FlashText

Gerber intentionally does not contain fonts or typographic text – this would introduce a complexity out of proportion to its benefits. Any text can be represented with the available graphic constructs, especially with contours. However, such generic graphic constructs do not maintain the information about which text string is represented.

The .FlashText aperture attribute transfers this otherwise lost information. .FlashText is designed for text image created with a flash. If the text is created with draws and arcs rather than a flash, it can always be flashed by collecting them in a block aperture.

Bar codes are handled as text – one can view a barcode as a special font.

The syntax and semantic of the attribute value is as follows:

<Text>,(B|C),[(R|M)],[],[Size],[<Comment>]

.FlashText fields	Usage
<text>	The text string represented by the aperture image.
(B C)	Indicates if the text is represented by a <i>barcode</i> – B -or by <i>characters</i> - C.
(R M)	Indicates if the text is readable or mirrored left-right . Optional.
	Font name. Content not standardized. Optional.
<Size>	Font size. Content not standardized. Optional.
<Comments>	Any extra information one wants to add. Optional.

An empty field means that the corresponding meta-data is not specified.

Examples:

```
%TA.FlashText,L1,C,R,Courier,10,Layer number (L1 is top)*%
```

Text: L1
 B|C: Characters,
 (R|M): Readable
 Font: Courier
 Size: 10
 Comment: Layer number (L1 is top)

```
%TA.FlashText,XZ12ADF,B,,Code128,,Project identifier *%
```

Text: XZ12ADF
 B|C: Barcode
 (R|M) Not specified
 Font: Code128
 Size: Not specified
 Comment: Project identifier

5.6.13 .N (Net)

The .N object attribute attaches a CAD netlist name to any conducting object. The attribute can be attached to objects on any copper layer or plated drill/rout file and to ComponentMain or ComponentPin objects on component layers. It indicates the object is part of the given net. The .N attribute is intended to allow quick visualization of nets and, more importantly, to define the CAD netlist.

The syntax is:

<.N Attribute> = .N,<netname>{,<netname>}

.N field	Usage
<netname>	The CAD net name. It can take any value conforming to the field syntax.



Example:

```
%TA.aperFunction,Conductor*%
%ADD21C,1*%           Create aperture 21, for conductive tracks
...
D21*                  Select aperture 21
%TO.N,Clk3*%         Select net Clk3
X5600000Y1200000D02* Move to the start of a track
X5600000Y1202500D01* Draw the tracks with Clk3 is attached
X5605000Y1205000D01*
X5605000Y1220000D01*
...
```

There are two reserved net names:

- 1) The empty string, defined by %TO.N,*% identifies objects not connected to a net, such as tooling holes, text, logos, pads for component leads not connected to the component circuitry.
- 2) The name N/C, defined by %TO.N,N/C*%, identifies a single pad net, as an alternative to giving each such net a unique name. (N/C stands for not-connected.)

Except the reserved names all net names must be unique.

It is recommended to attach a .N attribute to all copper objects, also those without net. The absence of the .N attribute does not mean there is no net and is therefore ambiguous.

Normally an object is fully connected and consequently belongs to a single net. However, if an object consists of different disconnected parts or is split in several disconnected parts by clear (LPC) objects it may belong to different nets. Then the .N attribute value must include all net names involved. It is recommended to avoid creating disconnected objects: one object, one net.

5.6.13.1 Etched Components

Etched components are embedded inductors, transformers and capacitors which are etched into the PCB copper. The following illustration shows two etched inductors.



They are identified by the .AperFunction attribute value 'EtchedComponent' on to the aperture used to create them. See `EtchedComponent`.

For the CAD netlist these are components like others: the net names are different on both sides. (However, for bare-board electrical test they may be conducting copper and simply connect the nets on both sides.)

Etched components do not need and normally do not have pads. There is no .P associated with them. The net on each side is different however.

5.6.14 .P (Pin)

The .P object attribute attaches the reference descriptor and pin number of a component pin to a pad on an outer copper layer or a ComponentPin in a component layer. The syntax is:

<.P Attribute> = .P,<refdes>,<number>[,<function>]

.P fields	Usage
<refdes>	The component reference descriptor. It can take any value conforming to the field syntax.
<number>	The pin number. It is normally a number but it can actually be any name. It must comply with the field syntax.
<function>	The pin function. It can take any value conforming to the field syntax. It is strongly recommended to include <i>both</i> pin number and pin function. The pin function is less prone to error than the pin number, and the redundancy provides extra security. This is especially important for diodes, electrolytic capacitors and transistors.



Example:

Take the following integrated circuit:



The pin attributes could be as follows:

```
D13*                               Select aperture 13 for the pads for IC12
%TO.P, IC12, 1, GND*%
X5600000Y1200000D03*              The Pad for IC12, pin 1, GND
%TO.P, IC12, 2, TRIG*%
X5600000Y1202500D03*              The Pad for IC12, pin 2, TRIG
...
```



Example (pin number only):

```
D13*                               Select aperture 13 for the pads for R5
%TO.P, R5, 1*%
X5600000Y1200000D03*              The pad for R5, pin 1
%TO.P, R5, 2*%
X5600000Y1202500D03*              The pad for R5, pin 2
...
```

The .P attribute can be attached to any pad belonging to a component pin, and only to those. (The pin number must be a non-empty field except if the pad is part of the component footprint but not connected to the component circuitry, e.g. %TO.P,U3,*%; pads with an empty number are normally not part of a net and therefore also have an empty net name defined by %TO.N,*%.) Consequently, .P can only be used on *component layers* and on *copper layers* that carry the components - typically the outer layers, but also inner layers with embedded or etched components.

A single component pad can consist of multiple flashes. Each flash then carries the same reference descriptor and pin number.

It is technically possible to create a single object representing multiple pads. For example, a single macro aperture can describe a complete component footprint. This is possible but *not allowed*. (It would be a neat way to make life miserable for CAM engineers though.)

5.6.15 .C (Component Refdes)

The .C object attribute attaches the component reference descriptor to an object. It indicates that the object belongs to the given component. It can be attached to objects on any layer. It is intended to identify e.g. which objects in a legend belong to which components.

The syntax is:

<.C Attribute> = .C,<refdes>

.C field	Usage
<refdes>	The component reference descriptor. It can take any value conforming to the field syntax.



Example in a legend layer:

D21*	Select aperture 21, used for component symbols
%TO.C,R2*%	Select reference descriptor R2
X5600000Y1200000D02*	Move to the start of the symbol
X5600000Y1202500D01*	Draw the symbol
X5605000Y1205000D01*	
X5605000Y1220000D01*	
...	

The attribute .C,R2 is attached to all tracks drawing the resistor symbol.

On component layers the .C attribute *must* be attached to all ComponentMain flashes and all ComponentOutline draws.

5.6.16 . Cxxx (Component Characteristics)

These attributes can be attached to the component objects in component layers. They provide information needed for assembly.

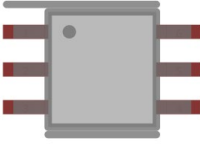
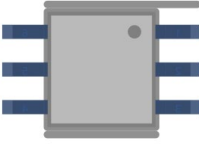
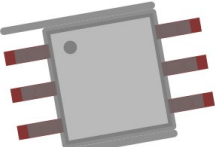
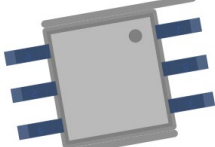
Object attributes	Usage
.CRot, <decimal>	<p>The rotation angle of the component.</p> <p>Rotation zero of a top side component is defined as in IPC-7351B. Rotation zero of a bottom side component is defined by flipping the rotation zero top side component <i>along</i> the X axis. Positive rotation always is counterclockwise as viewed from the top toward the bottom of the PCB.</p> <div style="display: flex; justify-content: space-around; align-items: center;"> <div style="text-align: center;"> <p>0° Top</p>  </div> <div style="text-align: center;"> <p>0° Bottom</p>  </div> </div> <div style="display: flex; justify-content: space-around; align-items: center; margin-top: 20px;"> <div style="text-align: center;"> <p>10° Top</p>  </div> <div style="text-align: center;"> <p>10° Bottom</p>  </div> </div> <p>Image courtesy Urban Bruhin.</p>
.CMfr, <field>	Manufacturer
.CMPN, <field>	Manufacturer part number
.CVal, <field>	Value, e.g. 220nF
.CMnt, (TH SMD Pressfit Other)	Mount type
.CFtp, <field>	Footprint. The name of the footprint or land pattern, the combination of pads to mount and connect the component. Follow IPC 7351B when possible. E.g. SOIC127P600X175-8.
.CPgN, <field>	Package name. The package is the container protecting the circuit and providing terminals for connections. Use the JEDEC package designators when possible. E.g. SOIC-16-N.
.CPgD, <field>	Package description.

<code>.CHgt, <decimal></code>	Height, in the unit of the file.
<code>.CLbN, <field></code>	Library name. Name of the component library from where the component information originates
<code>.CLbD, <field></code>	Library description. Description of the component library from where the component information originates
<code>.CSup, <SN>, <SPN>, {<SN>, <SPN>}</code>	Supplier. <SN> is a field with the supplier name. <SPN> is a field with a supplier part name

All ComponentMain and ComponentOutline objects must have a .C object attribute. The <RefDes> value for each component should be unique since it links the ComponentOutline objects to their ComponentMain object. The other .Cxxx attributes are only valid for ComponentMain objects. If attached to other objects, they are ignored.

5.7 Text in the Image

Gerber has no native font support – this would add too much complication in relation to the modest text requirements in PCB fabrication data. Text must be represented as pure image data, best as regions (contours), see 4.10.

Font definitions often contain splines and Gerber does has linear and circular segments but no splines. The splines must therefore be approximated to either linear or circular segments. Circular is more precise with less objects than linear, but mathematically more complicated.

An issue with representing text as image is that the information is lost that this image is text, and which string it represents. This is easily solved with the attributes `.AperFunction` (5.6.4.1) and `.FlashText` (5.6.4.3). (It may be counterintuitive, but these aperture attributes can be associated with regions; see 5.3, attributes on regions.) An example; suppose one needs to add the text 'Intercept' on the bottom copper layer. Here is how it goes:

<code>%TA.AperFunction,NonConductor*%</code>	<- Indicates the copper is not a conductor, typically text and graphics
<code>%TA.Flashtext,Intercept,C,M*%</code>	<- Indicates the copper represents the string 'Intercept', as characters and mirrored
<code>G36*</code>	
<code>...</code>	<- Draws creating the contours
<code>G37*</code>	
<code>%TD.AperFunction*%</code>	<- Deletes the attribute
<code>%TD.FlashText*%</code>	<- Deletes the attribute

5.8 Examples

The example below shows the usage of a simple aperture attribute.



Example:

G01*	
%ADD13R,200X200*%	G04 this aperture has no attribute*
D13*	
%TAIAmATA*%	G04 add attribute IAmATA in attributes dictionary*
X0Y0D03*	G04 this flash object has no attribute*
%ADD11R,200X200*%	G04 this aperture now has attached attribute IAmATA*
%TDIAmATA*%	G04 delete attribute IAmATA from current attribute dictionary*
%ADD12C,5*%	G04 this aperture does not have attribute IAmATA*
D11*	
X100Y0D03*	G04 this flash object has attribute IAmATA*
X150Y50D02*	
D12*	
X100Y150D01*	G04 this draw object has no attribute*

The next example illustrates an aperture attribute definition and changing value.



Example:

```

G01*
%TA.AperFunction, SMDPad*%      G04 Adds attribute .AperFunction in the
                                  current dictionary with value SMDPad to
                                  identify SMD pads*

%ADD11...*%                      G04 Aperture with number 11 gets
                                  the .AperFunction,SMDPad attribute attached*

%TA.AperFunction, Conductor*%    G04 Changes the value of .AperFunction
                                  attribute to define conductors*

%ADD20...*%                      G04 Aperture with number 20 gets
                                  the .AperFunction,Conductor attribute
                                  attached*

%TACustAttr, val*%              G04 Adds attribute CustAttr in the current
                                  attributes dictionary and sets its value to
                                  val*

%ADD21...*%                      G04 Aperture with number 21 is a conductor
                                  with attached attribute CustAttr = val*

%TD.AperFunction*%              G04 Deletes the .AperFunction attribute from
                                  the attributes dictionary*

%ADD22...*%                      G04 Aperture with number 22 has no
                                  attached .AperFunction attribute, but has
                                  attribute CustAttr = val*

%TDCustAttr *%                  G04 Deletes the CustAttr attribute from the
                                  attributes dictionary*

%ADD23...*%                      G04 Aperture with number 23 has no attached
                                  aperture attributes*

...

D11*                             G04 Set current aperture to aperture 11*
X1000Y1000D03*                   G04 Flash an SMD pad*
D20*                             G04 Use aperture 20 for graphical objects &
                                  attach it to regions*

X2000Y1500D01*                   G04 Draw a conductor*
%TA.AperFunction, Conductor*%    G04 Changes the value of .AperFunction
                                  attribute to define conductors*

G36*                             G04 Start a conductive region. IT TAKES ON
                                  THE ATTRIBUTE VALUES FROM THE DICTIONARY*

...

G37*
%TD*%                             G04 Clear attribute dictionary*
G36*                             G04 Start a region, without attributes*

...

G37*

```

6 PCB Fabrication and Assembly Data

6.1 Structure

PCB Fabrication data is a set of Gerber files and possibly files in other portable formats such as PDF. The files can either be in a directory or combined in a zip file. Other archive formats such as rar, 7z are not allowed.

6.2 Mandatory Attributes

A single Gerber file defines a single 2D layer image. A PCB, however, is a 3D object. To define a PCB one must not only define each layer, but also where it fits in the layer structure. This is defined by the following attributes, which are mandatory in fabrication data:

- .FileFunction
- .FilePolarity
- .SameCoordinates

6.3 Alignment

All data files in a fabrication data set must align – same offset, no mirroring, seen from the top to bottom. Data must be in 1/1 scale.

6.4 Pads

The fabricators must be able to distinguish between pads and other copper. For example, SMD pads often have stricter tolerances than other copper, pads are the test points for electrical test, and pads must be clear of legend. To identify pads all pads must be flashed (D03), and all flashes must be pads. Pads embedded in copper pours must also be flashed, although the flash does not affect the image – its purpose is to transfer information, namely the location and shape of the pad.

6.5 The Profile

The profile defines the physical extent of the PCB in a machine-readable manner. The profile is represented by a contour (G36/G37) or by a cleanly connected closed path made of draws/arcs (D01) obeying the same rules as for contour segments (see 4.10.3). In case the path uses a non-zero aperture *the center line* represents the profile. A profile may contain openings or cut-outs.

A fabrication data set *must* contain a separate file with the profile. Other layers *may* contain a replica of that profile provided its aperture has the .AperFunction,Profile attribute.

A roughly sketched outline, where lines do not connect cleanly, is not good enough. Corner marks are not good enough as they are only suitable for manual processing. Fabrication drawings can and should contain an outline drawing, but that is not a substitute for machine readable data, just as a drill map is not a substitute for drill data.

6.6 Drill/rout files

The image represents which material to remove. This specification does not differentiate between drilling and routing: the fabricator will determine what to drill and what to rout.

Only circular apertures can be used in drill and rout files, and then only in the following manner:

- For drill holes: flashes.
- For slots draws and arcs: a single draw/arc or a non-closed chain of draw/arcs
- For milling or cutouts (openings with a general shape): openings in the profile layer.

The drill/rout file image represents the *end diameter* of the hole; this is the diameter after plating, also known as the inner diameter. Routs are taken as is, the width of the aperture is the width. Cut-outs defined by draws where the center line defines the edge of the board does not belong to a rout file, add them to the profile layer.

Each drill span (from-to layers) must be put in a separate Gerber file. PTH and NPTH must be split into two separate files.

Drill files must be positive.



Note: Use Gerber rather than an NC format for drill and rout layers in fabrication data. The copper layers are in Gerber, and mixing formats is asking for problems, especially in registration. Gerber supports attributes, and Gerber files are typically of far better quality. The objection is sometimes raised that a Gerber file cannot be sent to a drill machine. While this is true, it is irrelevant for fabrication data. No fabricator uses his client's incoming files directly on his equipment but always loads them in the CAM system. The CAM system outputs the panelized drill files in the appropriate NC format, including feeds and speeds, exactly as the drill machine needs. If for whatever reason you need to output the drill files in an NC format, then use the XNC format, which is the only one that is clearly specified and targeted to CAD to CAM data transfer.

6.6.1 Backdrilling

An example explains best how to structure a job with backdrilling. Suppose we have an 8 layer job with backdrilling to remove via plating between layers 8 and 7. We need two files:

One file contains the via's. It has *.FileFunction Plated,1,8,PTH*. The drill tool has the via end diameter. Its *.AperFunction* value is *Via*.

The second file contains the backdrills. It has *.FileFunction NonPlated,8,7,Blind*. The drill tool has the same diameter as the via – the manufacturer will determine the tool diameter. Its *.AperFunction* value is *Backdrill*.

6.6.2 Example Drill File

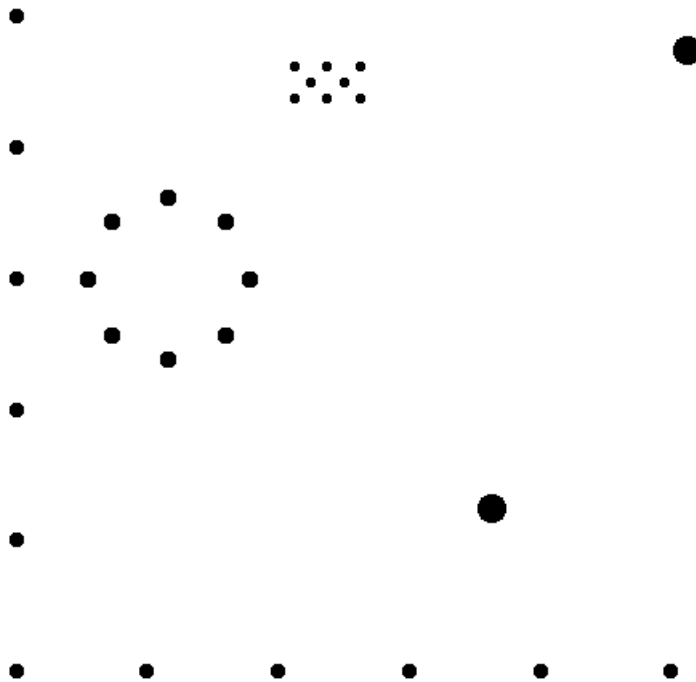

47. Example: drill file

Syntax	Annotation
<code>%FSLAX36Y36*%</code>	Format specification: Leading zeros omitted Absolute coordinates 3 integer and 6 fractional digits
<code>%MOMM*%</code>	Unit is mm
<code>%TF.FileFunction,Plated,1,8,PTH*%</code>	This file describes plated-through holes
<code>%TF.FilePolarity,Positive*%</code>	Always positive polarity for drill files
<code>%TF.Part,Single*%</code>	This file is part of a single PCB
<code>%TA.DrillTolerance,0.02,0.01*%</code>	Set the drill tolerance attribute to 0.02 mm in plus and 0.01 mm in minus in the attribute dictionary. It will be attached to all aperture definitions until changed or deleted
<code>%TA.AperFunction,ComponentDrill*%</code>	Attribute indicates that the following apertures define component drill holes.
<code>%ADD10C,0.14000*%</code>	Define the aperture to create holes with 0.14 mm end diameter. The AD command picks up the attributes in the attribute dictionary, which defines the as a component hole, with a 0.02 mm positive and 0.01 mm negative tolerance.

<code>%TA.AperFunction,Other,Special*%</code>	Attribute indicates that the following apertures are special drill holes
<code>%ADD11C,0.2400*%</code>	Define the aperture: a plated hole for a special purpose, with 0.24 mm end diameter with a tolerance of +0.02 mm and -0.01mm.
<code>%TA.DrillTolerance,0.15,0.15*%</code>	Changes the drill tolerance attribute for the following apertures to 0.15 mm in both directions
<code>%TA.AperFunction,MechanicalDrill*%</code>	Change the tool function attribute in the dictionary to mechanical
<code>%ADD12C,0.4300*%</code>	Define aperture 12 as a plated mechanical drill tool with 0.43 mm end diameter, and a tolerance of 0.15 mm in both directions.
<code>%ADD13C,0.2200*%</code>	Define aperture13, a tool with the same attributes but an end diameter of 0.22 mm
<code>%TD.AperFunction*%</code>	Remove the .AperFunction aperture attribute from the attributes dictionary
<code>%TD.DrillTolerance*%</code>	Remove the .DrillTolerance aperture attribute from the attributes dictionary
<code>G01*</code>	Set linear plot mode
<code>D10*</code>	Set aperture 10 as the current aperture.
<code>X2420000Y2750000D03*</code>	Create flash graphical objects with aperture 10: drill plated component holes with diameter 0.14 mm at the indicated coordinates
<code>Y3250000D03*</code>	
<code>X2170000Y3000000D03*</code>	
<code>X1920000Y3250000D03*</code>	
<code>X2920000Y2750000D03*</code>	
<code>X1920000D03*</code>	
<code>X2920000Y3250000D03*</code>	
<code>X2670000Y3000000D03*</code>	
<code>D11*</code>	
<code>X1240000Y0D03*</code>	Create flash graphical objects with aperture 11: drill plated special drill holes with diameter 0.24 mm at the indicated coordinates
<code>X0Y-1240000D03*</code>	
<code>X-1240000Y0D03*</code>	
<code>X880000Y880000D03*</code>	
<code>X-880000D03*</code>	
<code>X0Y1240000D03*</code>	
<code>X880000Y-880000D03*</code>	Set the current aperture to drill tool 12
<code>X-880000D03*</code>	
<code>D12*</code>	
<code>X7920000Y3500000D03*</code>	

X4920000Y-3500000D03*

Create flash graphical objects with aperture D12: drill plated mechanical drill holes with diameter 0.43 mm at the indicated coordinates

D13*

Set the current aperture to drill tool 13

X7670000Y-6000000D03*

X5670000D03*

Create flash graphical objects with aperture D13: drill plated mechanical drill holes with diameter 0.22 mm at the indicated coordinates

X-2330000Y2000000D03*

Y4000000D03*

Y0D03*

Y-2000000D03*

Y-6000000D03*

Y-4000000D03*

X-330000Y-6000000D03*

X1670000D03*

X3670000D03*

M02*

End of file

6.7 Drawings and Data

Gerber files in PCB fabrication data contains two types of images.

- Drawings, such as a drill map, a fabrication drawing or an assembly drawing. Such images are intended to be looked at by humans, and may contain vital fabrication instructions.
- Digital data representing the patterns of the copper, the solder mask, legend, drills. This digital data is intended to be processed by CAM software.

Unfortunately, the two are sometimes mixed, and drawing elements added to copper files etc. as in the example below.

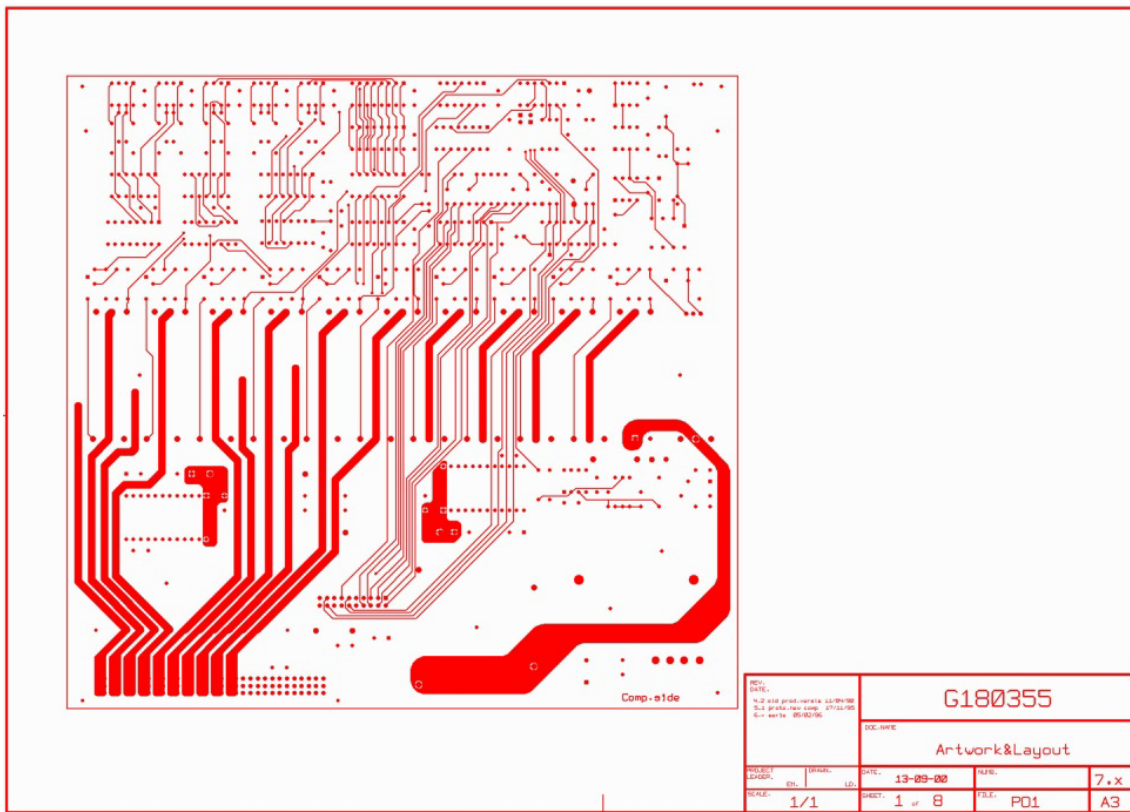

48. Confusing a drawing and digital data

Such a file is no longer machine readable. An operator must first manually remove the drawing elements. Before doing so he must check if these elements do not contain vital information and write this down somewhere for future reference. Keep data files pure. The drawings must contain all information that belongs to drawing. If need be, information that belongs to a specific file can be put in attributes. Less manual work, less risk of error. Simpler and cleaner.

6.8 The CAD Netlist

The CAD netlist describes which component pins are connected. Pins are identified by their component reference descriptor and pin number or name. Nets are identified by the net name. Here is an example of a CAD netlist; The first line lists all pins of net Clk3.

```
Clk3: U1-4,U2-3,U5-9,U6-9,U7-9
Sig11: U1-3,U5-12
Data8: U2-4,U5-10,U6-10,U7-8,U8-1
GND: U1-1,U2-1,U3-8,U4-16,U5-16,U6-1,U7-8,U8-8
...
```

The CAD netlist links component pads to nets. It specifies the function of the PCB and is the basis for the layout.

In Gerber the CAD netlist is defined by attaching both the pin and the net attribute to each component pad. This defines a pad – net entry in the CAD netlist, and at the same time associates a pad location and shape to it. For instance, the first entry in the CAD netlist above is given by the following sequence:

```
%TO.P,U1,4*%
%TO.N,Clk3*%
X...Y...D03*      The flash that creates the pad
...
```

It is recommended to add .P attribute to all electrical end points, not only physical component leads but edge connectors and test points. Although vias are part of a net, they are not component pads and cannot have a .P attached. Washer pads or any pads that are not part of a component cannot have a .P attached.

6.8.1 Benefits of Including the CAD Netlist

For the assembly process the location and orientation of each component must be known. This can easily be extracted from the Gerber file.

The netlist and component names facilitate the communication between the parties involved in design and fabrication. Viewers show more complete PCB information.

More importantly, the netlist information dramatically increases the security of the design to fabrication data transfer. If the image CAM reads from a Gerber file significantly differs from the image intended by CAD, due to bugs, operator errors or transmission errors, the inevitable result is scrap. Such a difference in image results in a difference in board netlist, which can be detected by comparing the calculated board netlist with the supplied CAD netlist. The CAD netlist therefore provides a very powerful redundancy check against image errors. To be precise, the following assert must be valid:

- Interpret all N/C's (not connected, meaning single pad nets) as unique names
- Flashes with the same reference descriptor and pad are deemed connected
- Etched components are removed before connection is calculated
- Assert 1: pads with the same net name must be connected
- Assert 2: pads with different net names must be isolated.

Lastly, a bare board PCB fabricator is expected to perform an electrical test on the bare PCB and guarantee the PCB conforms to the CAD netlist. It then is logical to provide him with the netlist to test against. Without providing the netlist the fabricator is expected to reverse engineer the netlist and must test against a reverse engineered net – hardly a secure procedure.

6.8.2 IP Considerations

Net names such as Clk13 provide information about the design. This may be a concern. A solution is to replace the meaningful names with obfuscated names such as a sequential number. This still allows to compare the design netlist with the image netlist as a redundancy check – meaningful names are not needed for that. The obfuscated names are a little less convenient when communicating between creator and receiver of the Gerber file, but both can still identify the same net as long as the creator can identify the net corresponding to the obfuscated name he created. Obfuscated names are sometimes a sensible balance between IP protection and data transfer security.

It is sometimes alleged that even a net list with obfuscated names pose an IP security risk as it still shows the connections between the pads. This is an obvious fallacy as the connections between the pads can be worked out from the image. In fact, if this were not true, a fabricator would be unable to perform a bare board electrical test without netlist information.

6.9 Component Data

6.9.1 Overview

The component information is included in two dedicated Gerber layers: the top and bottom component file. The purpose of the top and bottom component layers is to transfer the needed component information from CAD to manufacturing. The intended workflow is that the Gerber data is read into an assembly CAM system which allows to:

- analyze and check the component placement to check for errors and set up the assembly,
- visualize the component placement to check for errors and set up the assembly,
- generate the manufacturing tools such as the paste stencils and the pick and place machine programs,
- collect information to procure the components.

Component information was added in revision 2020.09, also called X3, by defining two new Gerber layers. By placing the component data in separate files, full compatibility is maintained: if one does not need component information, one can simply ignore the component layers. The new standard is therefore compatible with existing workflows. Legacy software can handle the CAD data with the new assembly information without change. Great care is taken to minimize the development effort by keeping the existing fabrication outputs in place and sticking to an existing syntax. Benefits:

- Compatible with installed base
- Minimal implementation work.
- Any decent legacy viewer displays the new component layers.

6.9.2 Assembly Data Set

Component information is included by adding component layers to the bare board fabrication data set. If the confidentiality of the design is a concern one can omit the inner layers as they do not affect assembly. Below is an example data set for a four-layer board:

```
%TF.FileFunction,Component,L1,Top*%  
%TF.FileFunction,Legend,Top*%  
%TF.FileFunction,Soldermask,Top*%  
%TF.FileFunction,Copper,L1,Top*%  
%TF.FileFunction,Copper,L4,Bot*%  
%TF.FileFunction,Soldermask,Bot*%  
%TF.FileFunction,Legend,Bot*%  
%TF.FileFunction,Component,L4,Bot*%  
%TF.FileFunction,Plated,1,4,PTH*%  
%TF.FileFunction,NonPlated,1,4,NPTH*% (If there are NPTH.)
```

The top and bottom component layers contain the component information needed for the assembly process. Attributes identify each component's location, orientation, identification, and properties such as manufacturer part number. The outer copper layers, mask, legend, and drill layers verify component placement and provide registration information for pick-and-place machines. An assembly drawing can contain information that is not included in the component layers.

The ComponentPin and .P attribute in the component layer specify the pin locations and as such unequivocally specify location and rotation of the components. The .P attribute is mandatory for each ComponentPin flash. Any .Cxxx attributes attached to a pin are ignored.

Local fiducials are deemed part of the footprint and can therefore be added to the component layer. The fiducial locations must be identified by a flash with zero-size circle aperture, with the attributes .AperFunction,FiducialPad,Local and .C,<refdes>. The zero size is chosen so as not to clutter the image.

See the Component Layers section of the table in 5.6.10, as well as 5.6.14, 5.6.15 and 5.6.16 for more information on specifying components.

6.9.3 Annotated Example Component Layer

Commands	Annotation
<pre>%TF.GenerationSoftware,KiCad,Pcbnew,(5.99.0-190-g0fd48dd4f-dirty)*% %TF.CreationDate,2019-10-02T18:52:55+02:00*% %TF.ProjectId,kit-dev-coldfire-xilinx_5213,6b69742d-6465-4762-9d63-6f6c646666972,2*% %TF.SameCoordinates,PX3e22018PY8d89728*% %TF.FileFunction,Component,L1,Top*% %TF.FilePolarity,Positive*% %FSLAX46Y46*% %MOMM*% %LPD*% G04 Aperture begin list* %TA.AperFunction,ComponentMain*% %ADD10C,0.3*% %TA.AperFunction,ComponentOutline,Courtyard*% %ADD11C,0.1*% %TA.AperFunction,ComponentPin*% %ADD12P,0.36X4X0.0*% %ADD13C,0.1*% %TD*% G04 Aperture end list* G04 Begin component info* D10* %TO.C,R301*% %TO.CFtp,R_0805_2012Metric*%</pre>	<p>This file is the top component layer</p> <p>The aperture for the flash with the main component information</p> <p>The aperture to draw the outline</p> <p>The aperture to flash the pin 1 location</p> <p>The aperture for the other pin locations</p> <p>Select main component aperture</p> <p>Attach reference descriptor R301</p> <p>Attach footprint</p>

Commands	Annotation
%TO.CVal,4K7*%	Attach value
%TO.CMnt,SMD*%	Attach mount type
%TO.CRot,-90*%	Attach rotation
X218250000Y-73000000D03*	Flash at reference point
D11*	Select outline aperture
X219250000Y-71310000D02*	Draw outline
X217250000Y-71310000D01*	Draw outline
X217250000Y-74690000D01*	Draw outline
X219250000Y-74690000D01*	Draw outline
X219250000Y-71310000D01*	Draw outline
D12*	Select key pin aperture
%TO.P,R301,1*%	Attach ref. desc and pin number
X218250000Y-72045000D03*	Flash at key pin location
D13*	Select subsequent pin aperture
%TO.P,R301,2*%	Attach pin 2 ident
X218250000Y-73955000D03*	Flash at pin location
%TD*%	Clear attributes before next component
G04 Next component*	
...	

7 Errors and Bad Practices

7.1 Errors

Poor implementation of the Gerber format can give rise to invalid Gerber files or – worse – valid Gerber files that do not represent the intended image. The table below lists the most common errors.

Symptom	Cause and Correct Usage
Standard Gerber or RS-274-D	Standard Gerber is revoked and is therefore <i>no longer valid</i> Gerber. It was designed for a workflow that is as obsolete as the mechanical typewriter. It requires manual interpretation and is therefore error prone. Do not use it. See 8.5. Always use Gerber X!
Clearances in planes disappear.	This is often the consequence of invalid cut-ins resulting in self-intersecting contours. The root cause is usually sloppy rounding aggravated by low-resolution output. Use 6 digits precision. See 4.10.3.
Rotating aperture macros using primitive 21 gives unexpected results.	Some CAD systems incorrectly assume that primitive 21 rotates around its center. This is wrong, it rotates around the origin. See 4.5.1.5.
Unexpected image after an aperture change or a D03.	Coordinates have been used without an explicit D01/D02/D03 operation code. This practice is deprecated because it leads to confusion about which operation code to use. Coordinate data must always be combined with an explicit D01/D02/D03 operation code. See 8.1.10.
Objects unexpectedly appear or disappear under holes in standard apertures.	Some CAD systems incorrectly assume the hole in an aperture <i>clears</i> the underlying image. This is wrong, the hole has <i>no effect</i> on the image. See 4.4.6.
Objects unexpectedly appear or disappear under holes in macro apertures.	Some CAD systems incorrectly assume that exposure off in a macro aperture <i>clears</i> the underlying objects under the flash. This is wrong, exposure off creates a hole in the aperture and that hole has no effect on the image. See 4.5.1.
Polygons are smaller than expected.	Some CAD systems incorrectly assume the parameter of a Regular Polygon specifies the inside diameter. This is wrong: it specifies the outside diameter. See 4.4.5.

The result of the MI command is not as expected.	The MI command mirrors coordinate data but not apertures. Some implementations unfortunately also mirror apertures making MI unsafe. It is therefore deprecated. Do not use the MI command but apply the transformation directly in the coordinate data. <i>See 8.1.7.</i>
The result of the SF command is not as expected.	The SF command scales coordinate data but not other sizes in the file. Some implementations unfortunately also scale other elements making SF unsafe to use. It is therefore deprecated. Do not use the SF command but apply the transformation directly in the coordinate data. <i>See 8.1.9</i>
A single Gerber file contains more than one image, separated by M00, M01 or M02	This is invalid. A Gerber file can only contain one image. One file, one image. One image, one file.
Sending a PCB layer as several positive/negative files that must be merged together.	This is <i>invalid</i> in Gerber X. <i>See 2.1.</i> (It was valid in Standard Gerber but became obsolete with the introduction of LPD/LPC in Gerber X.) Apart from being invalid this obnoxious practice requires manual work and is error prone. One wonders why someone in his right mind would use this archaic method, which has a serious risk of scrap. One file = one layer
Strange error message.	Some files contain the strange pseudo command %ICAS*%. One wonders what this is supposed to achieve. Anyhow, it is invalid.
Error message; not the intended image.	Invalid format specification %FSD....*% The only valid zero omission options in the %FS are L and T. D is invalid. <i>See 8.2.1.1.</i>
Strange error message.	*Presence of %FSLAN2X26Y26*% The N2 in the format specification is invalid. <i>See 4.2.2.</i> One wonders what it is supposed to achieve.
Strange error message.	...X5555Y5555I J001 Missing zero after the "I". Coordinates must have at least one digit. <i>See 4.2.2,</i> or the definition of an integer in the grammar in 3.5.

Reported errors

7.2 Bad Practices

Some Gerber files are syntactically correct but are needlessly cumbersome or error-prone. The table below summarizes common poor practices and gives the corresponding good practice.

Bad Practice	Problems	Good Practice
PCB fabrication data sets without proper profile layer.	The profile is an essential part of the fabrication data. It must be accurately defined, in a machine-readable manner. All too often only a drawing is provided, or corner marks, or the profile is only present merged in copper layers etc.	Always include a profile layer with a clean, accurately constructed profile. See 6.5
Painted copper pours (aka stroking or vector-fill)	Painted copper pours produce the intended image, but the file size explodes and getting rid of the painting require time consuming and error-prone manual work by CAM operators. Painting was needed for vector photoplotters in the 1960s and 1970s, devices now as outdated as the mechanical typewriter. There is not a single reason left to use painting.	Always define copper pours with contours (G36/G37)
Painted pads (aka stroking or vector-fill)	See painted copper pours above. Painting is even more damaging for pads, as the fabricator needs to know where the pads are, for example for electrical test. The only practical way to identify pads is to use flashes for pads exclusively.	Always use flashed pads. Define pads, including SMD pads, with the AD and AM commands.
Pads as contours or zero-length draws instead of flashes	See above.	Always use flashed pads. Define pads, including SMD pads, with the AD and AM commands.
PCB fabrication data sets without netlist.	PCB fabrication data is complex geometric data with an infinite number of variations. Differences in the interpretation of image data is very rare but does happen and then is costly. A netlist is a powerful check on the image data – it is akin to the redundancy checks used in all data transfer protocols. Omitting a netlist is omitting a basic security check.	Always include a netlist in a PCB fabrication data set. A netlist can be provided in IPC-D-356A file or with Gerber attributes – see 6.8.

<p>Low resolution (number of decimals in coordinates <6)</p>	<p>Poor registration of objects between PCB layers; loss of accuracy; self-intersecting contours; invalid arcs; turning small arcs into full circles, missing clearances. Poor numerical accuracy is the main cause for errors in geometric software. Low resolution is the root cause for most problems with Gerber files and sometimes leads to scrap.</p> <p>Why would one use low resolution? To save a few bytes? It is sometimes argued some Gerber readers can only handle low resolutions. This may have been true in the distant past but it is no longer true now. Will you risk scrap to cater for a few probably mythical antiquated implementations?</p>	<p>Use 6 decimals in mm units. See 4.1 and 8.2.1.</p>
<p>Cutting a single copper pour in pieces, typically through the clearances to avoid regions with holes.</p>	<p>The information what the copper pour is and where the clearances are is lost in a tangle of data, made worse by rounding error. The reader must attempt to laboriously reverse engineer the copper pour and clearances. Risk of scrap.</p>	<p>See section 4.10.5.</p>
<p>Imprecisely positioned arc center points</p>	<p>An imprecisely positioned center makes the arc ambiguous and open to interpretation. This can lead to unexpected results.</p> <p>See 4.7.2</p>	<p>Always position arc center points precisely.</p>
<p>Non-standard file extensions</p>	<p>When you use a non-standard file extension the reader must open the file to know what format it is and which application to use.</p> <p>See 3.5.</p>	<p>Please use “.gbr” or “.GBR” as file extension for all your Gerber files.</p>
<p>Writing files with deprecated constructs.</p>	<p>Each construct was deprecated for a reason. Many carry the risk of a misinterpretation. Continuing to use deprecated constructs is bad corporate citizenship as it blocks the industry from taking the next steps.</p>	<p>Generate files with current constructs only. (Note: it is OK for readers to handle deprecated constructs to cater for legacy files.)</p>

Bad/good practices

8 Deprecated Format Elements

8.1 Deprecated Commands

8.1.1 Overview

Current Gerber writers must not use the deprecated commands. Gerber readers may implement them to support legacy applications and files. The next table lists deprecated commands.

Code	Function	Comments
G54	Select aperture	This historical code optionally precedes an aperture selection Dnn command. It has no effect. Sometimes used. Deprecated in 2012.
G55	Prepare for flash	This historical code optionally precedes D03 code. It has no effect. Very rarely used nowadays. Deprecated in 2012.
G70	Set the 'Unit' to inch	These historical codes perform a function handled by the MO command. See 4.2.1. Sometimes used. Deprecated in 2012
G71	Set the 'Unit' to mm	
G90	Set the 'Coordinate format' to 'Absolute notation'	These historical codes perform a function handled by the FS command. See 4.1. Very rarely used nowadays. Deprecated in 2012.
G91	Set the 'Coordinate format' to 'Incremental notation'	
G74	Sets single quadrant mode	A more complicated way to create arcs. See 8.1.10. Rarely used, and then often without effect. Deprecated in 2020.
M00	Program stop	This historical code has the same effect as M02. See 4.13. Very rarely, if ever, used nowadays. Deprecated in 2012.
M01	Optional stop	This historical code has no effect. Very rarely, if ever, used nowadays. Deprecated in 2012.
IP	Sets the 'Image polarity' graphics state parameter	This command has no effect in CAD to CAM workflows. Sometimes used, and then usually as %IPPOS*% to confirm the default and it then has no effect. <i>As it is not clear how %IPNEG*% must be handled it is probably a waste of time to try to fully implement it, and sufficient to give a warning on a %IPNEG*% and skip it.</i> Deprecated in 2013

AS	Sets the 'Axes correspondence' graphics state parameter	<p>Deprecated in 2013. Rarely, if ever, used nowadays. If used it was nearly always, if not always, to confirm the default value and then these commands have no effect.</p> <p>It is a waste of time to fully implement these commands. The simplest is simply to ignore these commands. Theoretically safer is to skip them if they confirm the default and throw an error on any other use; chances are you will never see the error.</p>
IR	Sets 'Image rotation' graphics state parameter	
MI	Sets 'Image mirroring' graphics state parameter	
OF	Sets 'Image offset' graphics state parameter	
SF	Sets 'Scale factor' graphics state parameter	
IN	Sets the name of the file image. This has no effect on the image. It is no more than a comment.	<p>This is just a comment. Use G04 for comments. See 4.1. Ignore it.</p> <p>Sometimes used. Deprecated in 2013.</p>
LN	Loads a name. Has no effect. It is a comment.	<p>This is just a comment. Use G04 for comments. See 4.1. Ignore it.</p> <p>Sometimes used. Deprecated in 2013.</p>

Deprecated Gerber Commands

8.1.2 Axis Select (AS)

The AS command has been deprecated since revision I1 from December 2012.

The historical AS command sets the correspondence between the X, Y data axes and the A, B output device axes. It does not affect the image in computer to computer data exchange. It only has an effect how the image is positioned on an output device.

The order of execution is always MI, SF, OF, IR and AS, independent of their order of appearance in the file.

The AS command can only be used once, at the beginning of the file.

8.1.2.1 AS Command

The syntax for the AS command is:

AS = '%' (AS' ('AXBY' | 'AYBX')) '*%';

Syntax	Comments
AS	AS for Axis Select
AXBY	Assign output device axis A to data axis X, output device axis B to data axis Y. This is the default.
AYBX	Assign output device axis A to data axis Y, output device axis B to data axis X.

8.1.2.2 Examples

Syntax	Comments
%ASAXBY*%	Assign output device axis A to data axis X and output device axis B to data axis Y
%ASAYBX*%	Assign output device axis A to data axis Y and output device axis B to data axis X

8.1.3 Image Name (IN)

The IN command has been deprecated since revision I4 from October 2013.

The historical IN command gives a name to the image contained in the Gerber file. The name must comply with the syntax rules for a string as described in section 3.4.3. This command can only be used once, at the beginning of the file.

IN has *no* effect on the image. A reader can ignore this command. The informal information provided by IN can as well be put in a G04 comment.

8.1.3.1 IN Command

The syntax for the IN command is:

IN = '%' ('IN' name) '*%';

Syntax	Comments
IN	IN for Image Name
<Name>	Image name

8.1.3.2 Examples

Syntax	Comments
%INPANEL_1*%	Image name is 'PANEL_1'

8.1.4 Image Polarity (IP)

The IP command has been deprecated since revision I4 from October 2013.

IP sets positive or negative polarity for the entire image. It can only be used once, at the beginning of the file.

8.1.4.1 Positive Image Polarity

Under *positive* image polarity, the image is generated as specified elsewhere in this document. (In other words, the image generation has been assuming positive image polarity.)

8.1.4.2 Negative Image Polarity

The purpose of negative image polarity is to create a negative image, clear areas in a dark background. The entire image plane in the background is initially dark instead of clear. The effect of dark and clear polarity is toggled. The entire image is simply reversed, dark becomes white and vice versa.

In negative image polarity, the first graphical object encountered *must* have dark polarity.

8.1.4.3 IP Command

The syntax for the IP command is:

```
IP = '%' ('IP' ('POS' | 'NEG')) '*%';
```

Syntax	Comments
IP	IP for Image Polarity
POS	Image has positive polarity
NEG	Image has negative polarity

8.1.4.4 Examples

Syntax	Comments
%IPPOS*%	Image has positive polarity
%IPNEG*%	Image has negative polarity

8.1.5 Image Rotation (IR)

The IR command has been deprecated since revision I1 from December 2012.

IR rotates the entire image counterclockwise in increments of 90° around the image origin (0, 0). All image objects are rotated. The IR command affects the entire image. It must be used only once, at the beginning of the file. The order of execution is always MI, SF, OF, IR and AS, independent of their order of appearance in the file.

8.1.5.1 IR Command

The syntax for the IR command is:

IR = '%' ('IR' ('0'|'90'|'180'|'270')) '*%';

Syntax	Comments
IR	IR for Image Rotation
0	Image rotation is 0° counterclockwise (no rotation)
90	Image rotation is 90° counterclockwise
180	Image rotation is 180° counterclockwise
270	Image rotation is 270° counterclockwise

8.1.5.2 Examples

Syntax	Comments
%IR0*%	No rotation
%IR90*%	Image rotation is 90° counterclockwise
%IR270*%	Image rotation is 270° counterclockwise

8.1.6 Load Name (LN)

The IP command has been deprecated since revision I4 from October 2013.

This historical command has *no* effect on the image and can be ignored.

LN assigns a name to the subsequent part of the file. It was intended as a human-readable comment. Use the normal G04 command for human-readable comment. The LN command can be used multiple times in a file.

8.1.6.1 LN Command

The syntax for the LN command is:

LN = '%' ('LN' name) '*%';

Syntax	Comments
LN	LN for Load Name
<Name>	The name must comply with the syntax for a string, see section 3.4.3.

8.1.6.2 Examples

Syntax	Comments
%LNVia_anti-pads*%	The name 'Via_anti-pads' is to the subsequent file section

8.1.7 Mirror Image (MI)

The MI command has been deprecated since revision I1 from December 2012.

MI sets the mirroring for the coordinate data. All the *coordinate data* – and *only* coordinate data - are mirrored according to the specified factor. **Step and repeat distances are not coordinate data – see 4.9 - and hence are *not* mirrored. Apertures are *not* mirrored.**

This command affects the entire image. It can only be used once, at the beginning of the file. The default is no mirroring. The order of execution is always MI, SF, OF, IR and AS, independent of their order of appearance in the file.



Quite a number of implementations incorrectly also mirror apertures and/or step and repeat distances. These incorrect implementations make the MI too risky to use. We strongly recommend *not* to use MI on output as you do know how the reader will interpret the file. If an image must be mirrored, write out the mirrored coordinates and apertures.

8.1.7.1 MI Command

The syntax for the MI command is:

MI = '%' ('MI' ['A'('0'|'1')]['B'('0'|'1')]) '*%';

Syntax	Comments
MI	MI for Mirror image
A(0 1)	Controls mirroring of the A-axis data: A0 – disables mirroring A1 – enables mirroring (the image will be flipped over the B-axis) If the A part is missing, then mirroring is disabled for the A-axis data
B(0 1)	Controls mirroring of the B-axis data: B0 – disables mirroring B1 – enables mirroring (the image will be flipped over the A-axis) If the B part is missing, then mirroring is disabled for the B-axis data

8.1.7.2 Examples

Syntax	Comments
%MIA0B0*%	No mirroring of A- or B-axis data
%MIA0B1*%	No mirroring of A-axis data Mirror B-axis data
%MIB1*%	No mirroring of A-axis data Mirror B-axis data

8.1.8 Offset (OF)

The OF command has been deprecated since revision I1 from December 2012.

OF moves the final image up to plus or minus 99999.99999 units from the imaging device (0, 0) point. The image can be moved along the imaging device A or B axis, or both. The offset values used by OF command are absolute. If the A or B part is missing, the corresponding offset is 0. The offset values are expressed in units specified by MO command. This command affects the entire image. It can only be used once, at the beginning of the file. The order of execution is always MI, SF, OF, IR and AS, independent of their order of appearance in the file.

8.1.8.1 OF Command

The syntax for the OF command is:

OF = '%' ('OF' ['A' decimal]['B' decimal]) '*%';

Syntax	Comments
OF	OF for Offset
A<Offset>	Defines the offset along the output device A axis
B<Offset>	Defines the offset along the output device B axis

The **<Offset>** value is a decimal number n preceded by the optional sign ('+' or '-') with the following limitation:

$$0 \leq n \leq 99999.99999$$

The decimal part of n consists of not more than 5 digits.

8.1.8.2 Examples

Syntax	Comments
%OFA0B0*%	No offset
%OFA1.0B-1.5*%	Defines the offset: 1 unit along the A axis, -1.5 units along the B axis
%OFB5.0*%	Defines the offset: 0 units (i.e. no offset) along the A axis, 5 units along the B axis

8.1.9 Scale Factor (SF)

The SF command has been deprecated since revision I1 from December 2012.

SF sets a scale factor for the A- and/or B-axis coordinate data. All the *coordinate data* – and *only* coordinate data - are multiplied by the specified factor for the corresponding axis. **Step and repeat distances – see 4.9 - are not coordinate data and hence are not scaled. Apertures are not scaled.**

This command affects the entire image. It can only be used once, at the beginning of the file. The default scale factor is '1'. The factor values must be between 0.0001 and 999.99999. The scale factor can be different for A and B axes. The order of execution is always MI, SF, OF, IR and AS, independent of their order of appearance in the file.



Quite some legacy readers incorrectly also scale step and repeat distances. You cannot know how the reader will interpret the data and that make the SF too risky to use. Many readers simply do not support it. *Do not to use SF.* If an image must be scaled, write out the scaled coordinates.

8.1.9.1 SF Command

The syntax for the SF command is:

SF = '%' ('SF' ['A' decimal]['B' decimal]) '*%';

Syntax	Comments
SF	SF for Scale Factor
A decimal	The scale factor for the A-axis data.
B defimal	The scale factor for the B-axis data.

The scale factor is an unsigned decimal number n where $0.0001 \leq n \leq 999.99999$.

8.1.9.2 Examples

Syntax	Comments
%SFA1B1*%	Scale factor 1. A decimal.
%SFA.5B3*%	Defines the scale factor: 0.5 for the A-axis, 3 for B. Decimals.

8.1.10 Single-quadrant arc mode (G74)

Historically, there were two arc quadrant modes:

- ❑ Single quadrant mode, set by G74 command
- ❑ Multi quadrant mode, set by G75 command

The single-quadrant mode G74 was an unnecessary embellishment. It was used very rarely, and usually had no effect as it was overruled by a subsequent G75 before any arc was produced. Programmers voted against G75 with their keyboards. It was deprecated in 2021. Developers of Gerber input software will get a very long way without fully implementing G74 but only give an error when a G74 arc is created – this error will exceedingly rarely occur.

Quadrant mode	Comments
Single quadrant (G74) Deprecated	In single quadrant mode the arc is not allowed to extend over more than 90°. If the start point of the arc is equal to the end point, the arc has length zero, i.e. it covers 0°. A separate operation is required for each quadrant. A minimum of four operations is required for a full circle.
Multi quadrant (G75) Current	In multi quadrant mode the arc is allowed to extend over more than 90°. If the start point of the arc is equal to the end point, the arc is a full circle of 360°. Zero-length arcs cannot be constructed – they are useless anyhow.

Quadrant modes

The syntax of the G74 commands is:

G74 = :('G74') '*' ;



Example:

G74*

The syntax of the D01 command in single quadrant circular plot mode is:

D01 = (['X' x_coordinate] ['Y' y_coordinate] 'I' x_distance 'J' Y_distance) 'D01' '*' ;

Syntax	Comments
X x_coordinate	X_coordinate defines the X coordinate of the end point of the arc. It is of the coordinate data type. The default is the X coordinate of the current point.
Y y_coordinate	As above, but for the Y axis.
I x_distance	The x_distance defines the distance between the arc start point and the center parallel to the X axis. Distance is ≥ 0. It is of the coordinate data type.
J y_distance	As above, but for the Y axis.

Syntax	Comments
D01	Plot operation code

49. Circular plotting example

In single quadrant mode, awkwardly, *the sign of the offsets is omitted*, converting them to unsigned distances. There are four candidates for the center: (<Current X> +/- <X distance>, <Current Y> +/- <Y distance>). The center is the candidate that results in an arc with the specified direction, not greater than 90° and with the least deviation. The reason for this oddity is purely historic.

 **Example:**

Syntax	Comments
G74*	Set single quadrant mode
D10*	Select aperture 10 as current aperture
X1100Y600D02*	Set the current point to (11, 6)
G03*	Set counterclockwise plot mode
X700Y1000I400J0D01*	Create quarter arc object (radius 4) to (7, 10)
X300Y600I0J400D01*	Create quarter arc object (radius 4) to (3, 6)
X700Y200I400J0D01*	Create quarter arc object (radius 4) to (7, 2)
X1100Y600I0J400D01*	Create quarter arc object (radius 4) to (11, 6)
X300D02*	Create quarter arc object (radius 4) to (3, 6)
G01*	Set the current point to (3, 6)
X1100D01*	Set linear plot mode
X700Y200D02*	Create draw object to (11, 6)
Y1000D01*	Set the current point to (7, 2)
	Create draw object to (7, 10)

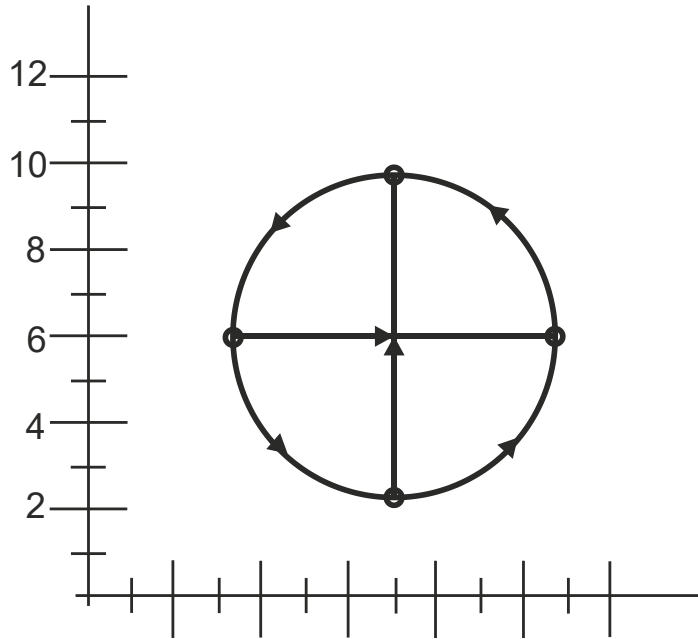

50. Single quadrant mode example: arcs and draws

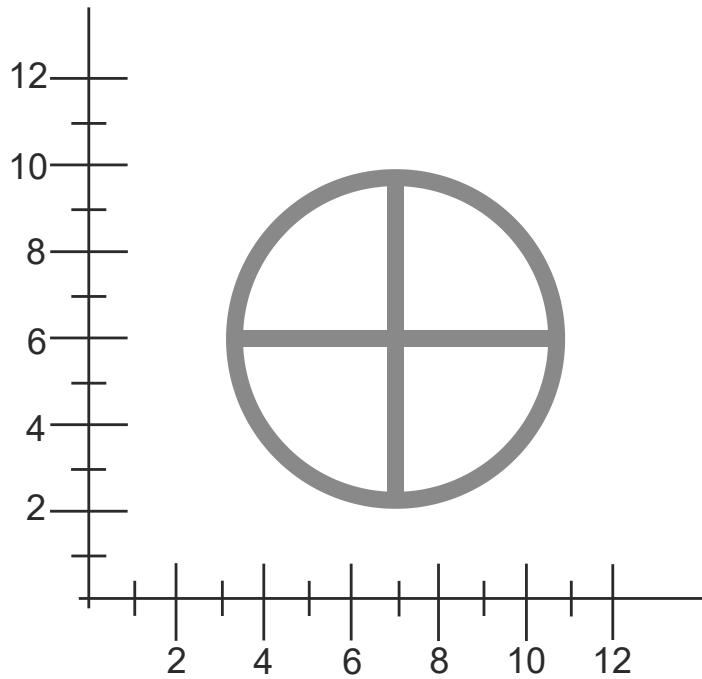

51. Single quadrant mode example: resulting image

An important difference between G74 and G75 arcs is what happens when start point and end point coincide. For G75 this represents a full 360° arc, in G74 a zero-degree arc. Some examples.

Syntax	Comments
D10*	Select aperture 10 as current aperture
G01*	Set linear plot mode
X0Y600D02*	Set the current point to (0, 6)
G74*	Set single quadrant mode
G02*	Set clockwise circular plot mode
X0Y600I500J0D01*	Create arc object to (0, 6) with radius 5

The resulting image is small dot, an instance of the aperture, at position (0, 6)

Syntax	Comments
D10*	Select aperture 10 as current aperture
G01*	Set linear plot mode
X0Y600D02*	Set the current point to (0, 6)
G75*	Multi quadrant mode
G02*	Set clockwise circular plot mode
X0Y600I500J0D01*	Create arc object to (0, 6) with center (5,6)

The resulting image is a full circle.

8.2 Deprecated Command Options

8.2.1 Format Specification (FS) Options

This section describes deprecated options of the FS command (see 4.1).

The FS command could also be used to specify the following format characteristics:

- ❑ Trailing zero omission
- ❑ Incremental coordinate notation
- ❑ Low resolution (less than 6 decimals).

8.2.1.1 Trailing Zero Omission

Trailing zero omission is deprecated since revision 2015.06.

Trailing zero omission some or all trailing zeros can be omitted but all leading zeros are required. To interpret the coordinate string, it is first padded with zeros at the back until its length fits the coordinate format. For example, with the “23” coordinate format, “15” is padded to “15000” and therefore represents 15.000.

The coordinate data must contain at least one digit. Zero therefore should be encoded as “0”.

Trailing zero omission is specified by ‘T’ after the FS code. (The normal leading zero omission is specified by ‘L’ after the FS code.)



Example:

```
%FSTAX26Y26*%
```

Trailing zero omission is rarely found in legacy files. Gerber readers will go a long way without supporting it.

8.2.1.2 Incremental Notation

Incremental notation is deprecated since revision I1 from December 2012.

Incremental notation means that coordinate values are as the incremental distances from the previous coordinate position. It is specified by the “I” in the FS command, after the “L” or “T” for leading or trailing. (The normal absolute notation is specified by ‘A’ in the FS command.)



Example:

```
%FSLIX26Y26*%
```

```
%FSTIX36Y36*%
```

Incremental notation was sometimes used as a simplistic compression when saving a few bytes was a fantastic advantage, and before the invention of Lempel–Ziv–Welch (LZW) and other *lossless* compression methods. The problem is that the accumulation of rounding errors leads to significant loss of precision. This results in poor registration, invalid arcs, self-intersecting contours, often resulting in scrap. Avoid incremental notation like the plague.

Incremental notation is fortunately but rarely used in legacy files. Gerber readers will go a long way without supporting it.

8.2.1.3 Low resolution

Low resolution, this is using less than 6 decimals is deprecated since revision 2015.06.

Low resolution was introduced in the 1960's as a simplistic compression method when saving a few bytes was of paramount importance, and computers were too feeble for proper *lossless* compression methods such as Lempel–Ziv–Welch (LZW).

Low resolution loses numerical precision, and poor numerical precision is the main cause of bugs in geometric software. It leads to poor registration of objects between PCB layers; loss of accuracy; self-intersecting contours; invalid arcs; small arcs turning in full circles, missing clearances. Low resolution was the main cause of problems with Gerber files, sometimes leading to scrap. The days that it was important to save a few bytes was important are long gone. What remains are the risks of low resolution. Avoid low resolution like the plague.

8.2.2 Rectangular Hole in Standard Apertures

Rectangular holes in standard apertures are deprecated since revision 2015.06. They occur very rarely in legacy files.



In addition to the round hole described in section 4.4 older versions of this specification also allowed rectangular holes. Rectangular holes do not rotate with the aperture, according to these historical specifications. This is very counterintuitive and a source of errors. Rectangular holes were deprecated because of this problem, and because rectangular holes are not very useful in the first place. Do not use them. If you need a rectangular hole construct a macro aperture.

The syntax of a rectangular hole was common to all standard apertures:

hole = x_hole_size Y y_hole_size

The parameters specify the X and Y sizes of the hole. Decimals >0.

The hole must fit *within* the standard aperture. It is centered on the aperture.



Example:

```
%FSLAX26Y26*%
%MOMM*%
%ADD10C,10X5X5*%
%ADD11C,1*%
G01*
%LPD*%
D11*
X-25000000Y-1000000D02*
X25000000Y1000000D01*
D10*
X0Y0D03*
```

M02*

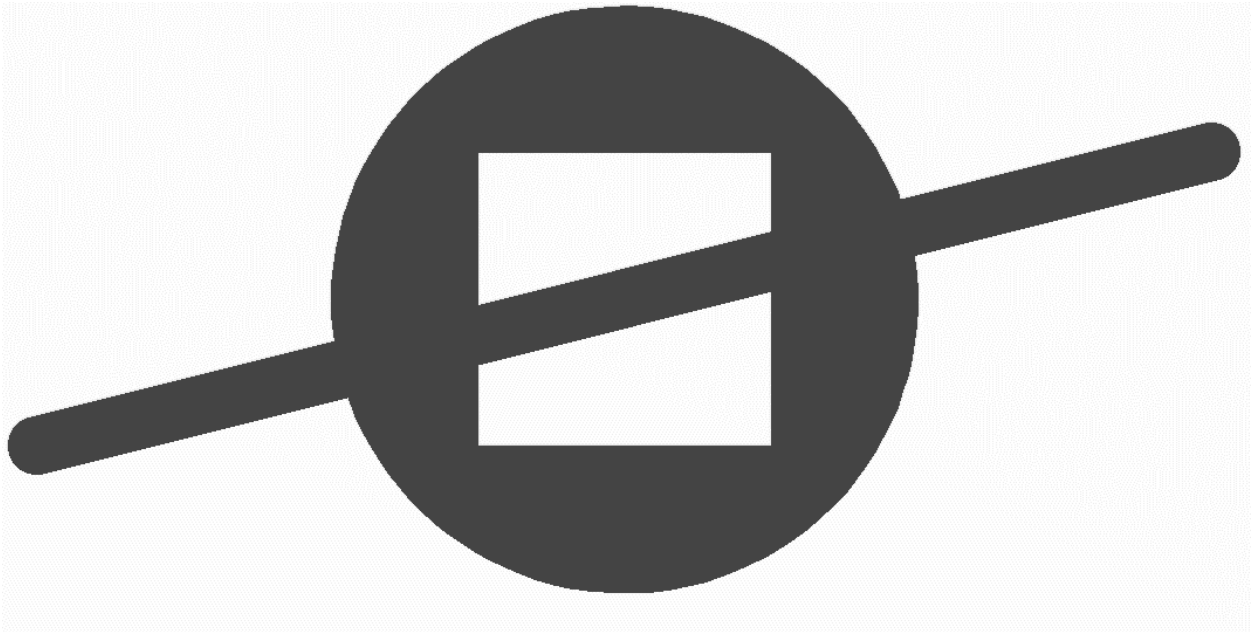

52. Standard (circle) aperture with a rectangular hole above a draw

Note that the draw is visible through the hole.

Rectangular holes appear very rarely in legacy files.

8.2.3 Draws and Arcs with Rectangular Apertures

The effect of stroking a line segment with a rectangular aperture is illustrated below. If the rectangle aperture is aligned with the line being stroked the result is a draw with line endings which have right angles:



53. Creating a draw: the aperture is aligned with line

If the rectangle is not aligned the result is as in the illustration below. The rectangle is *not* automatically rotated to align with the line being stroked.

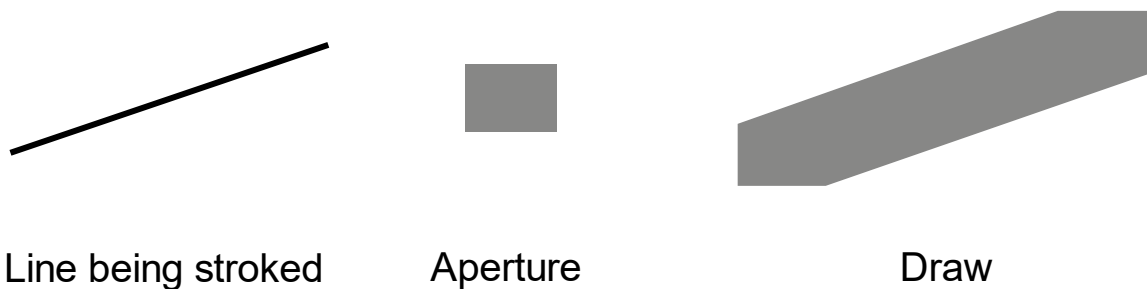

54. Creating a draw: the aperture is not aligned with line

This was only allowed with the solid rectangle *standard* aperture. Other standard apertures or macro apertures that fortuitously have a rectangular shape are not allowed.

This option was deprecated in 2020.09. Drawing with rectangular was never used often, even less at other angles than multiples of 90°. A developer of Gerber input will get a long way if he only implements a warning on plottings with rectangular apertures.

8.2.4 Macro Primitive Code 2, Vector Line

Primitive 2 was deprecated in 2015. It occurs but very rarely in legacy files.

Primitive 2 is identical to primitive 20. See 4.5.1.4.

8.2.5 Macro Primitive Code 22, Lower Left Line

Primitive 22 was deprecated in 2015. It occurs but very rarely in legacy files.

A lower left line primitive is a rectangle defined by its width, height, and the lower left point.

Modifier number	Description
1	Exposure off/on (0/1))
2	Rectangle width, a decimal ≥ 0 .
3	Rectangle height, a decimal ≥ 0 .
4	A decimal defining the X coordinate of lower left point.
5	A decimal defining the Y coordinate of lower left point.
6	A decimal defining the rotation angle around the <i>origin</i> (rotation is <i>not</i> around the center of the object)

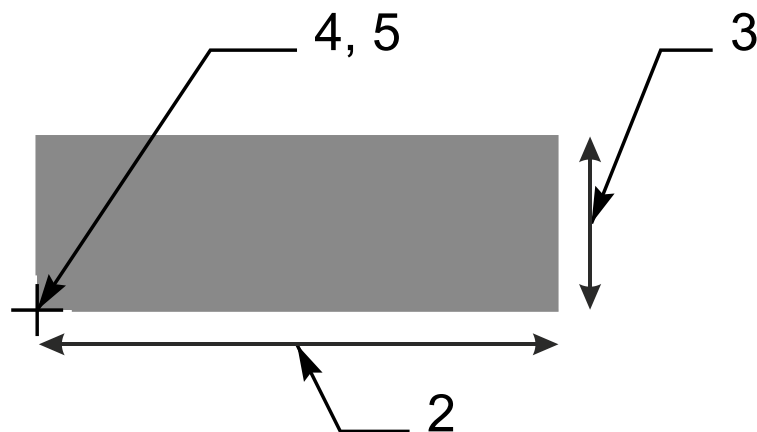

1. Line (lower left) primitive



Example:

```
%AMLIN2*22,1,6.8,1.2,0,0,0*%
```

8.2.6 Macro Primitive Code 6, Moiré

This primitive was deprecated in 2021. It is rarely used in legacy files.

The moiré primitive is a cross hair centered on concentric rings. Exposure is always on!

Parameter number	Description
1	Center point X coordinate.
2	Center point Y coordinate.
3	Outer diameter of outer concentric ring ≥ 0 .
4	Ring thickness ≥ 0 .
5	Gap between rings ≥ 0 .
6	Maximum number of rings. An integer ≥ 0 . The effective number of rings can be less if the center is reached. If there is not enough space for the inner ring it becomes a full disc.
7	Crosshair thickness ≥ 0 . If the thickness is 0 there are no crosshairs.
8	Crosshair length ≥ 0 . If the length is 0 there are no crosshairs.
9	Rotation angle, in degrees counterclockwise. The primitive is rotated around the origin of the macro definition, i.e. the (0, 0) point of macro coordinates.

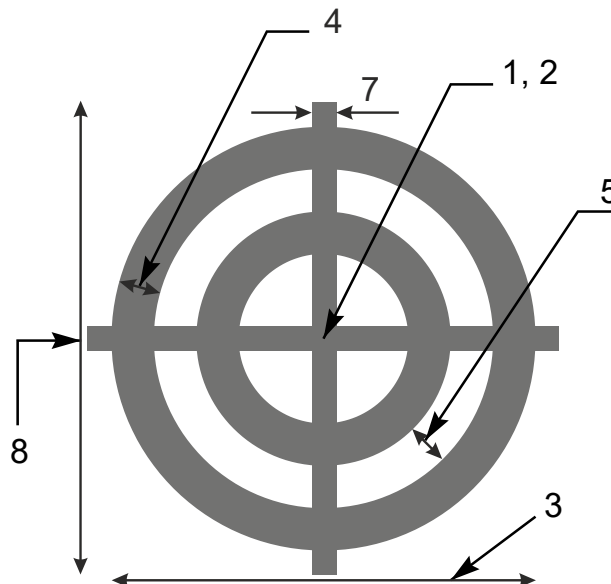

2. Moiré primitive



Example:

`%AMMOIRE*`

6,0,0,5,0.5,0.5,2,0.1,6,0*%

8.3 Deprecated Syntax Variations

8.3.1 Combining G01/G02/G03 and D01 in a single command.

This construction is deprecated since revision 2015.06.

The command codes G01, G02, G03 can be put at the beginning of the word containing a D01. The plot state is then set accordingly before D01 is executed and kept at the new value until superseded by a new command.



Example:

```
G01X100Y100D01*
X200Y200D01*
```

G01 sets the plot state to linear and processes the coordinate data X100Y100 from the same word accordingly as well as the coordinate data X200Y200 from the next word.

The syntax was as follows:

GnnD01 = ('G' ('01'|'02'|'03') coordinate_data 'D01') '*'

This construction happens quite frequently in legacy files, so readers may want to support it.

8.3.2 Coordinate Data without Operation Code

Coordinate data *without explicit operation code* after a D01, in other words the modal use of D01, is deprecated since revision I1 from December 2012.

A D01 code sets the deprecated operation mode to plot. It remains in plot mode till any other D code is encountered. In sequences of D01 operations this allows omitting an explicit D01 code after the first operation.



Example:

```
D10*
X700Y1000D01*
X1200Y1000*
X1200Y1300*
D11*
X1700Y2000D01*
X2200Y2000*
X2200Y2300*
```

The operation mode is *only* defined after a D01. The operation mode after a D02, D03 or an aperture selection (Dnn with nn≥10) is *undefined*. Therefore a file containing coordinates without operation code after a D02, D03 or an aperture selection (Dnn with nn≥10) is invalid.



Warning: Coordinate data without explicit operation code saves a few bytes but its exact use is not intuitive in relation to D03. The risk of scrap far outweighs the meager benefit.

8.3.3 Style Variations in Command Codes

Sometimes a word command such as G01 was spelled as G1, or g01, or G001. These variations were discouraged but tolerated. These variations were finally revoked in 2020.09 – only G01 style is allowed.

8.3.4 Deprecated usage of SR

These constructions are deprecated since revision 2016.01.

The command `%SRX1Y1I0J0*%` strictly speaking starts a step and repeat of 1x1, i.e. no step and repeat at all. It is historically sometimes used as an alternative for an `%SR*%` to close an SR statement. This is still used quite frequently.

Sometimes an SR command other than 1x1 such as `%SRX2Y3I1,5J2.2*%` is put seemingly inside an SR statement. Its effect is then to terminate the current SR statement and start a new one with its parameters. This is used rarely.

Another deprecated variation is that an SR statement at the end of a file is not closed. The end of file `M02*` is then an implicit close. This is used rarely.

Another variation is that the file header contains a `%SRX1Y1I0J0*%`. This does not mean a futile 1x1 step and repeat is started. It just indicates that the file does not start with a step and repeat, which is obvious. This command can be ignored. This is used quite frequently.

8.4 Deprecated Attribute Values

The following values for the `.AperFuntion` attribute were deprecated.

Drawing	This generic value was replaced by a range of specific drawing types such as <code>FabricationDrawing</code> etc.
CutOut	PCB cut-outs. This is the generic term for a hole other than a drill hole.
Slot	PCB slots. This is a subset of the cut-outs. Which cut-outs are called slots is subjective. In case of doubt use the value <code>CutOut</code> .
Cavity	Cavities in a PCB.

8.5 Standard Gerber (RS-274-D)

The current Gerber layer format is also known as RS-274X or Extended Gerber. There was also a historical format called Standard Gerber or RS-274-D format.

Standard Gerber is technically obsolete. It and was revoked in revision I1 from December 2012 and superseded by RS-274X.

Standard Gerber is revoked and superseded by Extended Gerber, which is the current Gerber format. Consequently, Standard Gerber no longer complies with the Gerber specification. Files in that format can no longer be correctly called Gerber files. Standard Gerber files are not only deprecated, they are simply invalid.



It differs from the current Gerber format (RS-274X), in that it:

- did not support G36 and G37 codes
- did not support any extended commands
- did not support attributes

Standard Gerber did not allow defining the coordinate format or aperture shapes. It was incomplete as an image description format. It lacked the imaging primitives needed to unequivocally transfer information from PCB CAD to CAM.

The word “standard” is misleading here. Standard Gerber was standard NC format. It was not a standard image format: image generation needs a so-called wheel file, and that wheel file was not governed by a standard. The interpretation of a wheel files, and consequently of a Standard Gerber files, was subjective. In Extended Gerber (RS-274X) image generation is fully governed by the standard. Extended Gerber is the true image standard.

Standard Gerber had major drawbacks compared to the current Gerber format and did not offer a single advantage. Standard Gerber is obsolete. There is not a single valid reason to use standard Gerber rather than Extended Gerber.

Always use Extended Gerber (RS-274X). Never use Standard Gerber.

 **Warning:** The responsibility of errors or misunderstandings about the wheel file when processing a Standard Gerber file rests solely with the party that decided to use revoked Standard Gerber, with its non-standardized wheel file, rather than Extended Gerber, which is unequivocally and formally standardized.

9 References

*American National Standard for Information Systems — Coded Character Sets — 7-Bit
American National Standard Code for Information Interchange (7-Bit ASCII), ANSI X3.4-1986*

<https://en.wikipedia.org/wiki/MD5>

<https://en.wikipedia.org/wiki/Unicode>

<https://en.wikipedia.org/wiki/UTF-8>

http://en.wikipedia.org/wiki/ISO_8601

https://en.wikipedia.org/wiki/Binary_image

[https://en.wikipedia.org/wiki/Zip_\(file_format\)](https://en.wikipedia.org/wiki/Zip_(file_format))

<https://tools.ietf.org/html/rfc4122>

[https://msdn.microsoft.com/en-us/library/windows/desktop/aa378623\(v=vs.85\).aspx](https://msdn.microsoft.com/en-us/library/windows/desktop/aa378623(v=vs.85).aspx)

https://developer.apple.com/library/mac/documentation/Foundation/Reference/NSUUID_Class

The Inventor's Dilemma: The Remarkable Life of H. Joseph Gerber,
by David Gerber, ISBN 978-0-300-12350-0

<https://tatsu.readthedocs.io/en/stable/>. Documentation for the TatSu PEG parser generator.

https://en.wikipedia.org/wiki/Parsing_expression_grammar

<https://bford.info/packrat/> Bryan Fords page on parsing expression grammars.

IPC-4761

IPC-TM-50

IPC-7351B

10 History

The Gerber format derives its name from the former Joseph Gerber, inventor, entrepreneur, and the pioneer of photoplotting. A leading supplier of vector photoplotters from the 1960s onwards, Gerber based its plotter input on a subset of the EIA RS-274-D NC format, and in 1980, it published a well-written specification titled "Gerber Format: a subset of EIA RS-274-D; plot data format reference book". The format was well suited for its task and it and became the de-facto standard format for vector plotters, known as *Standard Gerber*.

Vector photoplotters are NC machines, and Standard Gerber, which is dedicated to vector photoplotters, is an NC format. As of the 1980s, raster photoplotters started to replace vector plotters. These newer bitmap devices required more than a simple NC format, so Gerber extended the original NC format with so called "Mass Parameters", converting it to a fully-fledged image format. This resulted in a family of effective image description formats designed specifically to drive Gerber's PCB devices and raster plotters.

In 1998 Gerber Systems Corp. was taken over by Barco and incorporated into its PCB division – Barco ETS, now Ucamco. Barco drew all the variants in Gerber's family of formats into a single standard image format. It was published on September 21, 1998 in the Gerber RS-274X Format User's Guide. The format became known as Extended Gerber or GerberX. Extended Gerber is a full image description format, containing the complete description of a PCB layer. Unlike Standard Gerber, it does not need the support of additional external files, and it specifies planes and pads clearly and simply without the need for painting or vector-fill. The Extended Gerber format quickly superseded Standard Gerber as the de facto standard for PCB image data. It is called "the backbone of the electronics industry". A sequence of revisions clarifying the specification was published over the years, culminating in revision H of January 2012.

During 2012, Ucamco reviewed the entire format in depth. Over 10000 files from all over the world were gathered into a representative library to help establish current practice. Rarely used and historical format elements were deprecated. Format elements with conflicting interpretations in the market were either deprecated or clarified. The specification document itself was re-organized, the quality of the text and the drawings was improved and many new drawings added. This resulted in The Gerber Format Specification, revision I1 published in December 2012. Revisions I2, I3 and finally I4 from November 2013 further improved the document. The result was a powerfully clear and simple format, without needless embellishments, focused on the current needs of the PCB industry. This version of the Gerber Format was developed by Karel Tavernier and Rik Breemeersch. They were assisted by an advisory group including Ludek Brukner, Artem Kostyukovich, Jiri Martinek, Adam Newington, Denis Morin, Karel Langhout and Dirk Leroy. Grateful thanks are extended to all those who helped the development of the revision by posting their questions, remarks and suggestions on the Ucamco website. Particular thanks are due to Paul Wells-Edwards whose insightful comments contributed substantially to the revision.

Until this point, Gerber was purely an image description format. Recognizing that a PCB image must be supported with meta-information that describes, say, the function of an image file in the layer structure, Ucamco realized that it could convey that information clearly and unequivocally using attributes. Accordingly, and in June 2013, the company publicly proposed to extend the Gerber format with attributes. It invited feedback on its proposal from the Gerber user community. The outcome of this was revision J1, completed in February 2014, during which Gerber got its attributes. It was a major step forward for the format, at least on a par with the changes made when Standard Gerber became Extended Gerber. Sometimes called the second extension, the latest version of the Gerber format is known as Gerber version 2, or X2 (as opposed to X1, which is Gerber without attributes). Gerber version 2 is fully backward compatible as attributes do not affect the image at all. Subsequent revisions, J2 to J4, clarified

Revision 2026.05

- Copyright Ucamco NV

Having a question or remark about the spec? Please contact us at gerber@ucamco.com

the specification and added new standard attributes. Gerber version 2 was developed by Karel Tavernier, Ludek Brukner and Thomas Weyn. They were assisted by an advisory group including Roland Polliger, Luc Samyn, Wim De Greve, Dirk Leroy and Rik Breemeersch.

In September 2014 Ucamco published an open letter declaring Standard Gerber obsolete and revoking it.

Early in 2015, the entire specification was reviewed once again by Karel Tavernier, Thomas Weyn, and Artem Kostyukovich focused on making the specification easier to read and understand, while taking great care to ensure consistent and precise terminology. Some further elements were identified as superfluous and were deprecated. Not least, special attention was given to the 'Overview' chapter, with the aim of turning it into a tutorial that can be understood by non-experts. The result of this work is revision 2015.06.

In August 2015, Ucamco published a draft specification *adding nested step and repeat* and block apertures to make panel descriptions more efficient, calling for comments from the user community. In November 2016 the review process was closed after substantial input and modifications and the final version included in revision 2016.12. This revision was developed by Karel Tavernier and Rik Breemeersch.

In July 2016 Karel Tavernier from Ucamco published a draft specification to include netlist information in Gerber for public review. Several revisions of the draft were triggered by input from users. The final version was included in revision 2016.11 from November 2, 2016.

In March 2017 Karel Tavernier from Ucamco published a draft specification to include fab documentation in Gerber for public review.

In May 2020 Karel Tavernier from Ucamco published a specification for including component information in Gerber, aka X3.

11 Revisions

11.1 Revision 2026.05

Corrected typos pointed out by Baton Prog. Improved the text according to suggestions by Jim J. Jewett. Manoj Kumar did a very thorough review of the whole specification; the errors he pointed out were corrected and his suggestions for text improvements implemented.

Revision 2026.05 was developed by Karel Tavernier.

11.2 Revision 2024.05

The mount type attribute `.CMnt, (TH|SMD|Fiducial|Other)` was replaced by `.CMnt, (TH|SMD|Pressfit|Other)`.

Added section 5.1.1 on comment attributes.

Corrected text errors, pointed out by Krzysztof Wiśniewski. Corrected an error in the formal syntax in 4.2.2 and a text error in 8.1.10, pointed out by Bruce McKibben. The graphics state after an AB definition was clarified. Clarifications related to fiducials, based on suggestions by Jim J. Jewett. Corrected typos pointed out by Jim J. Jewett.

Revision 2024.05 was developed by Karel Tavernier.

11.3 Revision 2023.08

The mandated aperture for pins other than pin 1 in the component layers was modified from zero-size to a circle of 0.1mm or 0.004 inch, after discussion with Wim De Greve, Jean-Pierre Charras and Dirk Leroy.

The order of mirroring and rotation for aperture transformations in section 4.9.1 was clarified, as suggested by Adam Newington. Errors in examples pointed out by Hans Forssell were corrected. The `.Cxxx` standard attributes were added to the synoptic table in 5.1.

Revision 2023.08 was developed by Karel Tavernier.

11.4 Revision 2023.03

The version field in the `.GenerationSoftware` file attribute was made mandatory, see 5.6.7.

We corrected an error in the macros in section 4.5.5.4 and in 6.5, pointed out by Tony Luken. We clarified that the `%TD` command has no effect on the file attributes, an ambiguity that was pointed out by Hardy Woodland; see sections 5.2 and 5.5.

Revision 2023.03 was developed by Karel Tavernier.

11.5 Revision 2022.02

The formal grammar in section 3.5 was simplified, without changing the language itself. Section 4.2.2. Format Specification (FS) and section 4.10.1 Region Overview were rewritten. Typos

pointed out by Nicholas Meeker were corrected. The awkward term interpolating was replaced by plotting.

Revision 2022.02 was developed by Karel Tavernier.

11.6 Revision 2021.11

Several improvements in the description of component attributes suggested by Bruce McKibben. Improved the text of the .CRot spec, as suggested by Urban Bruhin. Corrected a typo, pointed out by Bradley Lin. Corrected an error in the EBNF grammar of .Part, pointed out by Paul M. Johnson. Corrected an error in 4.2.1 and 4.9.1 pointed out by Grzegorz Kimbar. Corrected a large number of typos and errors pointed out by Frog Chen – we expressly thank him for his very careful review of the spec.

Revision 2021.11 was developed by Karel Tavernier.

11.7 Revision 2021.04

We fixed errors and typos pointed out by Bruce Mc.Kibben and Jim J. Jewett - we thank them for the very careful proof reading. The definition of the coordinate system was added to 4.2, as suggested by Graham Wideman, who helpfully supplied the illustrations.

Revision 2021.04 was developed by Karel Tavernier.

11.8 Revision 2021.02 – Formal grammar

Deprecated single quadrant mode (G74) and macro primitive code 6 (moiré).

The specification now includes a formal grammar for the complete format. See 3.5.

Several typos were fixed thanks to Nick Meeker and Kevin Shi for their careful review. The term 'data block' was replaced by 'word' to eliminate confusion with aperture blocks.

Revision 2021.02 was developed by Karel Tavernier.

11.9 Revision 2020.09 – X3

In March 2020 a specification for including component information – Gerber X3 2020.03 – was published. Gerber X3 was developed in discussion with a team of people. Karel Tavernier developed a prototype specification which was circulated privately with Wim De Greve, Jean-Pierre Charras, Thiadmer Riemersma, Bruce McKibben and Rafal Powierski in December 2018. In intense discussion among this group the draft went through five revisions until a first public draft was published in October 2019, calling for input from the user community. The review process was closed in February 2020 with the publication of the separate X3 specification, now merged in this document.

This separate specification on components is now merged into this main specification.

Gerber now accepts Unicode characters for attribute values that contain user-defined meta-information, and therefore may require special characters and other languages than English.

Draws with rectangular apertures were deprecated, see 8.2.3, as were some style variations in word commands, see 8.3.3.

Clarified the semantics of the .GenerationSoftware attribute. Specified more clearly how drill files must be constructed, as suggested by Wim De Greve and Luc Samyn.

Revision 2026.05

- Copyright Ucamco NV

213

Having a question or remark about the spec? Please contact us at gerber@ucamco.com

Fixed errors pointed out by Greg Huangqi and Jim J. Jewett. Especially Jim J. Jewett reviewed the specification in great detail. Replaced the unusual term 'modifier' with the more usual term 'parameter'.

Revision 2020.09 was developed by Karel Tavernier.

11.10 Revision 2019.09

Replaced the option [Filled|NotFilled] on the ViaDrill value of the .AperFunction attribute with the more specific IPC-4761 types, see 5.6.10.

Revision 2019.09 was developed by Karel Tavernier.

11.11 Revision 2019.06

The .AperFunction values CutOut, Slot and Cavity were deprecated. See 8.3.

Made it more explicit that macro aperture names cannot be reused. Corrected an error in the examples pointed out by Abe Tusk, and in 2.1, pointed out by Radim Halíř.

Revision 2019.06 was developed by Karel Tavernier.

11.12 Revision 2018.11

Removed the .PF attribute, and replaced its content by an additional optional field to the .P attribute. See 5.6.14.

Fixed a number of typos and minor errors pointed out by Jörg Naujoks, Rik Breemeersh and Radim Halíř.

Revision 2018.11 was developed by Karel Tavernier.

11.13 Revision 2018.09

Corrected an error in the polygon aperture, section 4.4.5, and polygon primitive, section 4.5.1.7. Clarified the rotation of the deprecated rectangular holes in apertures, section 8.2.2 These issues were pointed out by Remco Poelstra.

Corrected an error in the moiré primitive specification, section 8.2.6. The error was pointed out by Vasily Turchenko.

Clarified how object attributes are attached to regions, triggered by remarks from Radim Halíř.

Defined allowed range of the scale factor in 4.9.5, as suggested by Andreas Weidinger.

Defined orientation of text mirroring in section 5.6.12. Triggered by Nicholas Meeker.

Nicholas Meeker, Andreas Weidinger, Radim Halíř and Denis Morin carefully proofread the document, which resulted in many text corrections.

Revision 2018.09 was developed by Karel Tavernier.

11.14 Revision 2018.06

Removed PressFit option from the ComponentPad attribute value; it is also a ComponentDrill option and that is sufficient.

Revision 2026.05

- Copyright Ucamco NV

Having a question or remark about the spec? Please contact us at gerber@ucamco.com

Clarified pad attribute values for via, component, SMD, BGA on inner layers. Clarified FS command, see 4.1 and 8.2.1. Fixed broken links to references indicated by Vasily Turchenko.

Revision 2018.06 was developed by Karel Tavernier.

11.15 Revision 2018.05

Added .PF attribute, as suggested by Matthew Sanders.

Corrected errors in an example in 4.9.1 pointed out by Erik Forwerk. Corrected errors in the SR definition and Backus-Naur form pointed out by Remco Poelstra, see 4.11. Simplified the Backus-Naur form of the region statement, see 4.10.2. Corrected an error in 5.4 pointed out by Dries Soentjens.

Revision 2018.05 was developed by Karel Tavernier.

11.16 Revision 2017.11

Allow the .N attribute not only on copper layers but also on plated drill layers, see 5.6.13.

Remove .FileFunction value Keep-out. Use Profile instead.

Specified that to combine files zip is the only allowed archive format, as suggested by Rafal Powierski.

Simplified the Backus-Naur form of aperture blocks, see 4.11.2. Added synoptic table with macro primitives in 4.5.1.1. Added synoptic table one with standard apertures in 4.4.1. Added Backus-Naur form of the region statement. Added link to the Reference Gerber Viewer in 1.3. Fixed typos pointed out by Forest Darling. Fixed a number or typos pointed out by Radim Halíř.

Revision 2017.11 was developed by Karel Tavernier.

11.17 Revision 2017.05

Added the new file attribute .SameCoordinates, see 5.6.5.

Added file functions Depthrout, Viafill, Vcut, and Vcutmap.

Created section 5.6.16 with guidelines on the use of attributes in fabrication data; added guidelines on how to define the PCB profile in 6.2.

Reorganized and edited the chapter Overview. Clarified section on zero-size apertures.

Corrected an error in the comment in example 6.6.2 pointed out by Nav Mohammed. Corrected errors in the examples in 5.6.5 pointed out by Rik Breemeersch,

Revision 2017.05 was developed by Karel Tavernier.

11.18 Revision 2017.03

Added section 5.6.16, specifying how to put text in the image.

Changed file function *Gluemask* to *Glue*; added explanation; see 5.6.3.

Reorganized chapter 3.5. Extended section 4.10.5.

Corrections in 4.9.1, 4.9.5, 4.10.1 and in Aperture Attributes on Regions triggered by remarks from Remco Poelstra. Corrected an error in an example pointed out by Danilo Bargaen.

Revision 2017.03 was developed by Karel Tavernier.

11.19 Revision 2016.12 – Nested step and repeat

This is a major revision with powerful new imaging functions: 4.11, 4.9.3, 4.9.4 and 4.9.5. These allow nested step and repeat to define panels efficiently, see 4.11.3 and 0.

There are fixes for errors in examples, pointed out by Danilo Bargaen and Urban Bruhin.

Revision 2016.12, and especially the new imaging function for panels was developed by Karel Tavernier and Rik Breemeersch. The first draft of these functions was published in August 2016. During the public review process. Thomas Weyn, Bruce McKibben, Masao Miyashita and Remco Poelstra provided essential input.

11.20 Revision 2016.11

This major revision allows to include the CAD netlist to Gerber files by adding three new standard object attributes – see 5.6.16 above. The goal of the Gerber CAD netlist is to facilitate upfront communication between the different parties involved in design, assembly and automation. The X2 attributes proposed include CAD netlists in Gerber fabrication data and allow to:

- Attach the component reference designator, pin number and net name to the component pads in the outer copper layers. This information is essential for a complete board display and for a complete board display. More importantly, the netlist provides a powerful checksum to guarantee PCB fabrication data integrity.
- Attach the netlist name to any conducting object on any copper layer. Lightweight viewers can then display netlists without the need for an algorithm to compute connectivity
- Attach the component reference to any object, e.g. to identify all the legend objects belonging to a given component, for example.

Several text improvements. Section 4.10.3 on regions clarified triggered by deep questions asked by Remco Poelstra.

Revision 2016.11 was developed by Karel Tavernier. Jean-Pierre Charras provided essential input on the CAD netlist, and further remarks by Remco Poelstra and Wim De Greve were included.

11.21 Revision 2016.09

New or modified attribute values – see 5.6.10:

- Replaced file function *Drawing* with *OtherDrawing*.
- Added the optional field *Filled|NotFilled* to *ViaDrill*.
- Added aperture function *EtchedComponent*.

Added object attributes – see 5.4. Object attributes attach information to individual graphical objects.

Corrected an error in example 4.10.4.6. The error was pointed out by Thomas van Soest and Siegfried Hildebrand. Clarified the syntax of attaching aperture attributes to regions. Added Perl script to show precisely how to calculate the .MD5. Several other clarifications.

Revision 2016.09 was developed by Karel Tavernier.

11.22 Revision 2016.06

Added a section on back-drilling job triggered by questions from Alexey Sabunin. See 6.6.1.

The .ProjectID UUID was changed to RFC4122; rewritten by Remco Poelstra. See 5.6.8.

Aperture function attributes were clarified triggered by remarks from John Cheesman. Drill sizes were clarified triggered by remarks from Jeff Loyer.

11.23 Revision 2016.04

Added PressFit label to component drill and pad attributes; see ComponentPad and ComponentDrill. Revoked default on current point.

Text improvements that do not change the format: Removed superfluous concept of level and replaced the name 'Level Polarity' by 'Load Polarity'. Various other text improvements.

11.24 Revision 2016.01

Added drill and pad functions for castellated holes. Added optional types break-out and tooling on MechanicalDrill.

Deprecated closing an SR with the M02.

Text improvements that do not change the format: Clarified .AperFunction attribute values. Clarified when to use of standard or user attributes. Clarified how aperture attributes can be set on regions.

11.25 Revision 2015.10

Added items to section Errors and Bad Practices.

Added file function attribute .FilePolarity.

Refined drawing .FileFunction attributes Replaced Mechanical by FabricationDrawing and Assembly by AssemblyDrawing. Added definitions to the drawing types. Added mandatory (Top|Bot) to .AssemblyDrawing, as suggested by Malcolm Lear. Added ArrayDrawing.

11.26 Revision 2015.07

The superfluous and rarely, if ever, used macro primitives 2 and 22 were revoked.

The .AperFunction aperture attribute was simplified:

- Filled / NotFilled option is removed for the ViaDrill function
- ImpC / NotC option is removed from the Conductor function

11.27 Revision 2015.06

New file attributes were specified: *.GenerationSoftware* (5.6.5), *.CreationDate* (5.6.5) and *.ProjectId* (5.6.8).

The mistakenly omitted rotation parameter of the circle macro primitive was restored. Unicode escape sequences in strings are now defined.

Operation syntax combining the G and D codes in a single word were deprecated. The rectangular hole in standard apertures was deprecated. Usage of low resolutions and trailing zero omission in the FS command was deprecated.

The entire document was revised for clarity. The readability of the text was improved. The terminology was made consistent. The glossary was expanded. A number of additional images were added, including the Gerber file processing diagrams, command types diagram, aperture macro rotation illustration. Some of existing images were recreated to improve the quality. Several new tables were added to explain the relation between D code commands and graphics state parameters. The glossary was updated. The sections were rearranged.

From now the revision numbering follows the year.month scheme as in 2015.06.

11.28 Revision J4 (2015 02)

The .AperFunction values “Slot”, “CutOut” and “Cavity” were added. The text on standard attributes was made more explicit. An example of a poorly constructed plane was added.

11.29 Revision J3 (2014 10)

The .FileFunction values for copper and drill layers were extended to contain more information about the complete job.

11.30 Revision J2 (2014 07)

Attaching aperture attributes with regions was much simplified. A section about numerical accuracy was added.

11.31 Revision J1 (2014 02) – X2

This revision created Gerber X2 by adding attributes to what was hitherto a pure image format. See chapter 5. X2 is Gerber version 2, with “X1” being Gerber version 1, without attributes. Gerber X2 is backward compatible as attributes do not affect image generation.

11.32 Revision I4 (2013 10)

The commands LN, IN and IP were deprecated. The possibility of re-assigning D codes was revoked.

The regions overview section 4.10.1 was expanded and examples were added different places in 4.10 to further clarify regions. The chapters on command codes and syntax were restructured. The constraints on the thermal primitive parameters were made more explicit. Wording was improved in several places. The term ‘(mass) parameter’ was replaced by ‘extended command’.

11.33 Revision I3 (2013 06)

Questions about the order and precise effect of the deprecated commands MI, SF, OF, IR and AS were clarified. Coincident contour segments were explicitly defined.

11.34 Revision I2 (2013 04)

The “exposure on/off” parameter in macro apertures and the holes in standard apertures are sometimes incorrectly implemented. These features were explained in more detail. Readers and writers of Gerber files are urged to review their implementation in this light.

11.35 Revision I1 (2012 12)

General. The entire specification was extensively reviewed for clarity. The document was re-organized, the text and the drawings have been improved and many new drawings were added.

Deprecated elements. Elements of the format that are rarely used and superfluous or prone to misunderstanding have been deprecated. They are grouped together in the second part of this document. The first part contains the current format, which is clean and focused. *We urge all creators of Gerber files no longer to use deprecated elements of the format.*

Graphics state and operation codes. The underlying concept of the *graphics state* and operation codes is now explicitly described. See section 2.3.2 and 2.3.2. *We urge all providers of Gerber software to review their implementation in the light of these sections.*

Defaults. In previous revisions the definitions of the default values for the modes were scattered throughout the text or were sometimes omitted. All default values are now unequivocally specified in an easy-to-read table. See 2.3.2. *We urge all providers of Gerber software to review their handling of defaults.*

Rotation of macro primitives. The rotation center of macro primitives was clarified. See 4.5.3. *We urge providers of Gerber software to review their handling of the rotation of macro primitives.*

G36/G37. The whole section is now much more specific. *We urge providers of Gerber software to review their contour generation in this light.*

Coordinate data. Coordinate data without D01/D02/D03 in the same word can lead to confusion. It therefore has been deprecated. See 8.1.10. *We urge all providers of Gerber software to review their output of coordinate data in this light.*

Maximum aperture number. In previous revisions the maximum aperture number was 999. This was insufficient for current needs and numerous files in the market use higher aperture numbers. We have therefore increased the limit to the largest number that fits in a signed 32-bit integer.

Standard Gerber. Standard Gerber is revoked because it has many disadvantages and not a single advantage. *We urge all users of Gerber software not to use Standard Gerber any longer.*

Incremental coordinates. These have been deprecated. Incremental coordinates lead to rounding errors. *Do not use incremental coordinates.*

Name change: area and contour instead of polygon. Previous revisions contained an object called a polygon. This caused confusion between this object and a polygon aperture. These objects remain unchanged but are now called areas, defined by their contours. This does not alter the Gerber files.

Name change: level instead of layer. Previous revisions of the specification contained a concept called a layer. These were often confused with PCB layers and have been renamed as levels. This is purely narrative and does not alter the Gerber files.